

# OZITO

## AIR RANDOM ORBITAL SANDER

### 150mm (6")

#### INSTRUCTION MANUAL

#### SPECIFICATIONS

|                          |                  |
|--------------------------|------------------|
| Sanding Pad Size:        | 150mm (6")       |
| Max. Air Pressure:       | 91psi (6.3Bar)   |
| Average Air Consumption: | 113 l/min (4cfm) |
| No Load Speed:           | 10,000/min       |
| Air Inlet:               | 1/4" BSP         |
| Weight:                  | 1.73kg           |

ASR-150

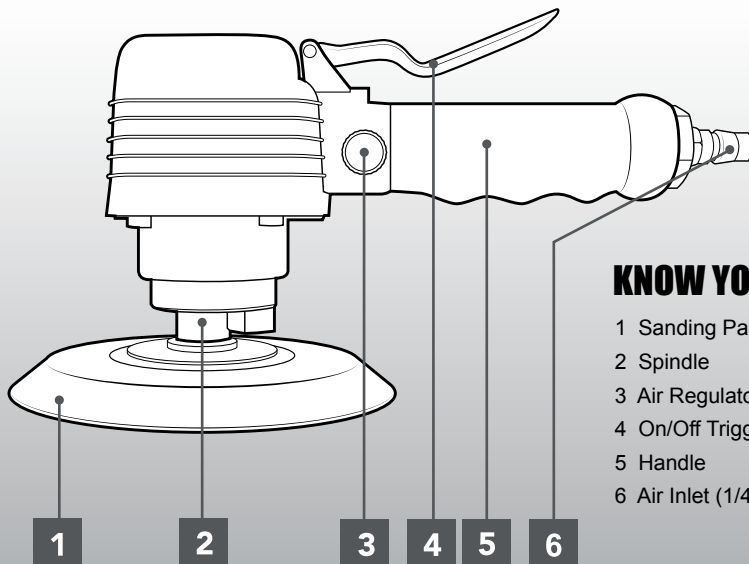

#### KNOW YOUR PRODUCT

- 1 Sanding Pad
- 2 Spindle
- 3 Air Regulator
- 4 On/Off Trigger
- 5 Handle
- 6 Air Inlet (1/4" Nitto Fitting)

## GENERAL AIR TOOL SAFETY WARNINGS

**WARNING!** Read all safety warnings and all instructions. Failure to follow the warnings and instructions may result in electric shock, fire and/or serious injury. Save all warnings and instructions for future reference. The term "power tool" in the warnings refers to your mains-operated (corded) power tool or battery-operated (cordless) power tool.

1. **Work area safety**
  - a. **Keep work area clean and well lit.** Cluttered or dark areas invite accidents.
  - b. **Do not operate power tools in explosive atmospheres, such as in the presence of flammable liquids, gases or dust.** Power tools create sparks which may ignite the dust or fumes.
  - c. **Keep children and bystanders away while operating a power tool.** Distractions can cause you to lose control.
  - d. **Dress properly. Do not wear loose clothing or jewellery. Keep your hair, clothing and gloves away from moving parts.** Loose clothes, jewellery or long hair can be caught in moving parts.
  - e. Check the maximum pressure rating of any tools or accessories that you intend using with the compressor. The output pressure of the air from the compressor must be regulated so that it never exceeds the rated pressure of the tool or accessory.
  - f. Always wear safety goggles or glasses when using the air compressor. Never point the nozzle of an accessory towards any part of your body or towards another person.
  - g. **Drain the moisture from the tank daily.** It will help prevent corrosion.

- h. Use safety equipment including safety goggles or shield, ear protection, breathing respirator mask and protective clothing.
- i. Air tools should not be used in a potentially explosive environment.
- j. Use safety equipment including safety goggles or shield, ear protection, breathing or respirator mask and protective clothing.
- k. **The tool must be used only for its prescribed purpose.** Any use other than those mentioned in this Manual will be considered a case of misuse. The user and not the manufacturer shall be liable for any damage or injury resulting from such cases of misuse.

**WARNING!** In the event that an air line is cut or broken, the air supply must be turned off at the compressor. A broken air line which is not supported is extremely dangerous and can whip around very quickly, both with the capability of striking people, and blowing foreign particles into the air. Do not attempt to catch the air line but immediately keep bystanders well clear and turn off the air supply to the hose, turn off the compressor at the On / Off button, and then remove the hose from the compressor.

**This appliance is not intended for use by persons (including children) with reduced physical, sensory or mental capabilities, or lack of experience and knowledge, unless they have been given the supervision or instruction concerning use of the appliance by a person responsible for their safety.**

Children should be supervised to ensure that they do not play with the appliance.

## AIR SANDER SAFETY WARNINGS

- WARNING!**
- **Disconnect the sander before changing accessories.** Accidental start-ups may occur if the sander is plugged in while changing an accessory.
  - **Disposing of dust.** Be extremely careful of dust disposal, materials in fine particle form may be explosive. Do not throw sanding dust on an open fire. Spontaneous combustion, may in time, result from a mixture of oil or water with dust particles.
  - **Always wear eye protection and a dust mask for dusty applications and when sanding overhead.** Sanding particles can be absorbed by your eyes and inhaled easily and may cause health complications.
  - **Use special precautions when sanding chemically pressure treated timber, paint that may be lead based, or any other materials that may contain carcinogens.** A suitable breathing respirator and protective clothing must be worn by all persons entering the work area. Work should be sealed by plastic sheeting and persons not protected should be kept out until work area is thoroughly cleaned.
  - **Do not 'wet sand' with this sander.**
  - **Never place your hands near rotating components.** Accessory may kickback over your hand.

• **Do not use sandpaper intended for larger sanding pads.** Larger sandpaper will extend beyond the sanding pad causing snagging, tearing of the paper or kick-back. Extra paper extending beyond the sanding pad can also cause serious lacerations.

- WARNING!**
- Some dust created by power sanding, sawing, grinding, drilling and other construction activities contain chemicals known to cause cancer, birth defects or other reproductive harm. Some examples of these chemicals are:
- Lead from lead-based paints;
  - Crystalline silica from bricks, cement and other masonry products, and;
  - Arsenic and chromium from chemically-treated timber.

Your risk from these exposures varies, depending on how often you do this type of work. To reduce your exposure to these chemicals: work in a well ventilated area and work with approved safety equipment, such as dust masks that are specially designed to filter out microscopic particles.

## DESCRIPTION OF SYMBOLS

|      |   |    |                         |
|------|---|----|-------------------------|
|      | Warning                                 |    | Read instruction manual |
|      | Wear ear protection                     |    | Wear eye protection     |
| /min | Revolutions or reciprocation per minute | No | No load speed           |

## SPARE PARTS

Spare parts can be ordered from the Special Orders Desk at your local Bunnings Warehouse.

For further information, or any parts not listed here, visit [www.ozito.com.au](http://www.ozito.com.au) or contact Ozito Customer Service:

Australia 1800 069 486

New Zealand 0508 069 486

Email: [enquiries@ozito.com.au](mailto:enquiries@ozito.com.au)

# CONNECTING TO COMPRESSOR

1. Remove black plastic cap from the air inlet.

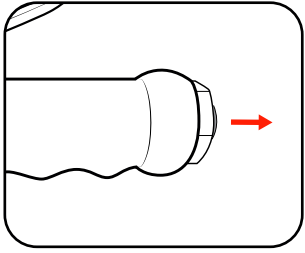

2. Wrap the threaded male end of an air fitting with thread sealing tape in a clockwise direction.

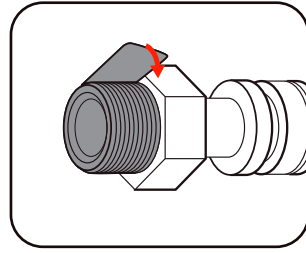

3. Screw the male nitto fitting clockwise into the female end of the air inlet.

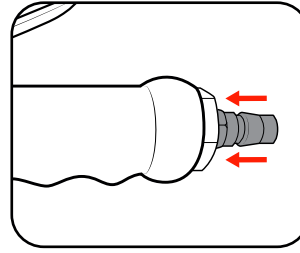

4. Pull back the sleeve on hose fitting, insert male end & release sleeve on hose fitting.

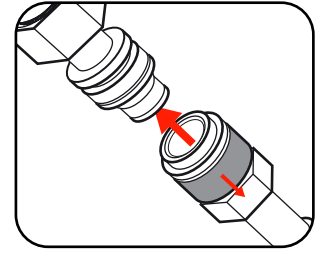

**Note:** This tool is rated at 90psi. Ensure your compressor is set no higher than 90psi.

# FITTING THE SANDING PAD & SAND PAPER

**Note:** Disconnect the tool from the air supply before fitting or removing attachments.

1. Lock the spindle by either holding with a spanner (not included) or rotating the counter-weight 90°.

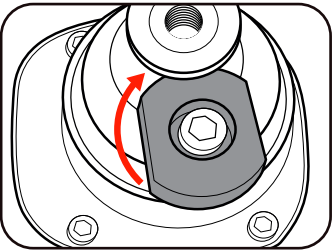

2. Screw the sanding pad tightly onto the spindle by rotating clockwise.

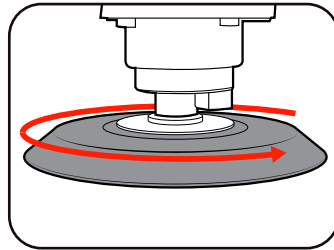

3. Press the sand paper onto the sanding pad, making sure to align the edges.

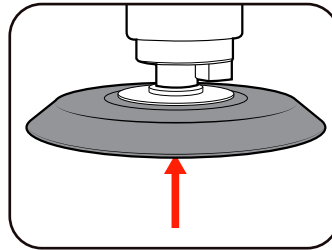

4. To remove the sand paper, peel off starting from one edge.

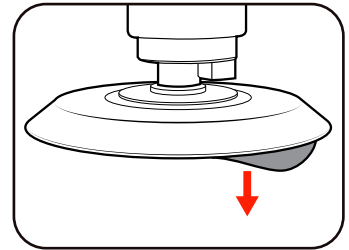

**Note:** Before operating, ensure the counter weight is rotated out of the way so that the spindle is free to spin.

# OPERATION

1. Ensure that the workpiece is secured with clamps to avoid movement while sanding.

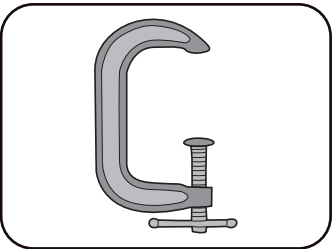

2. Ensure the counter-weight is rotated out of the way, so that the spindle is free to spin.

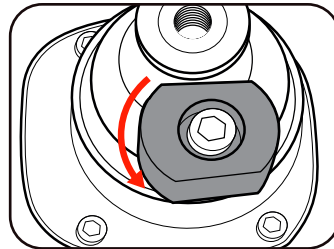

3. Press the on/off trigger down to start sanding. To stop the sander, release the on/off trigger.

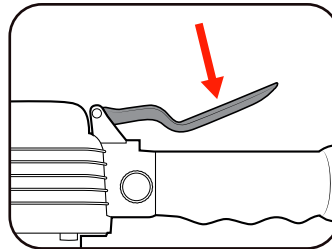

4. To adjust the rotational speed of the sander, rotate the air regulator dial until the desired setting is achieved.

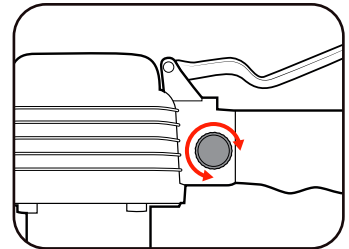

# MAINTENANCE

- If the enclosure of the sander requires cleaning, do not use solvents but a moist soft cloth only. Never let any liquid get inside the sander; never immerse any part of the sander into a liquid.
- Store the tool in a dry and safe place out of reach of children.
- **Oil the air sander after each use.**

# TROUBLESHOOTING

**If the sander fails to work effectively, perform the following checks:**

- Check that the air regulator dial is not completely closed.
- Check the air inlet is free of any dirt or blockages.
- Ensure the sander is lubricated properly.
- Check that the pressure on the air compressor is within its working range. If not, let the compressor rest to re-pressurise / refer to the compressor instruction manual.