

5 TIER ADJUSTABLE SHELF

1830H x 910W x 410Dmm POWDER COATED

Very Important!







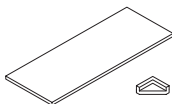

Unpack the unit and confirm that you have all the parts listed. Assemble the unit on a solid level surface, avoid carpet. You will need the assistance of a second person during assembly. You will need the following: Rubber Mallet or Hammer.

Note: Do not place additional MDF boards on shelving brackets until completion of shelving unit!

SAFETY TIP:

When assembling or installing this product wear protective gloves and eyewear.

Parts List

-  MDF Shelves x 5
 -  Foot Caps x 8
 -  Connector Pins x 4
 -  Brackets 'A' x 6
 -  Brackets 'B' x 6
 -  Brackets 'C' x 4
 -  Brackets 'D' x 4
 -  Braces 'E' x 5
 -  Legs 'F' x 8
- NOT TO SCALE

Step 1

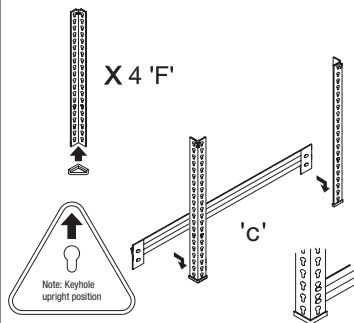

Place foot end caps onto the bottom of the 4 legs 'F'. Note upright position. Place shelving bracket 'A' onto the legs 'F'. A rubber mallet can be used to lightly tap all brackets into the keyholes of the legs into place. Allow one keyhole free between the foot end cap and the shelving bracket.

Step 2

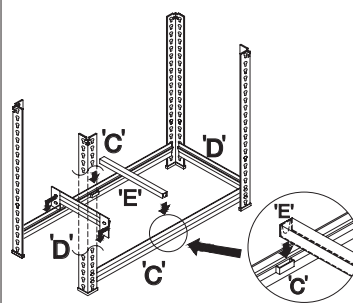

Use shelf bracket 'B' for the side brackets using the shelf bracket from Step 1 as a guide for height. Allow 1 keyhole free from the ground as shown in the diagram. Use same shelving brackets for opposing sides as shown in the diagram. Place brace 'E' as shown.

Step 3

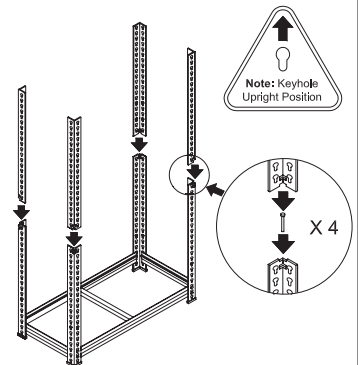

Place MDF board on bottom shelf to minimise buckling. Join the upper legs to the lower legs with the connector pins. Note: The legs are designed to sit directly on top of each other – don't overlap them. Handy Hint: Flathead screwdriver may be used to tap in connector pins.

Step 4

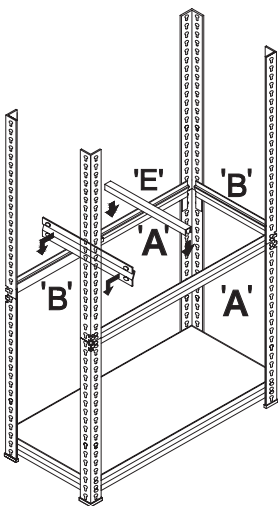

Fix brackets 'D' so that the top rivet sits on the upper legs and the bottom rivets sit on the lower legs. Repeat with brackets 'C', followed by brace 'E' as shown.

Step 5

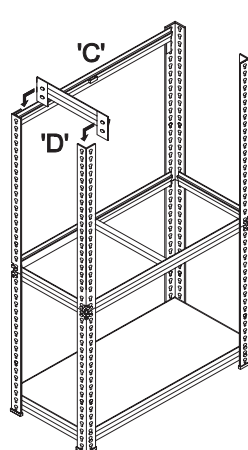

Fix brackets 'C' at the very top allowing room for the MDF board to sit flush against the legs. Repeat with brackets 'D'.

Step 6

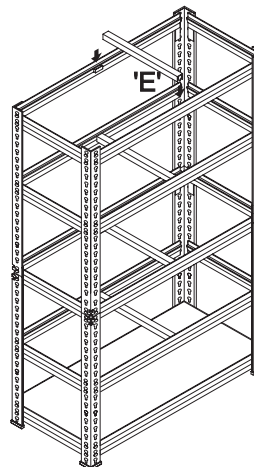

Apply remaining brackets as above to desired height. Ensure that braces 'E' are fixed to all shelves.

Step 7

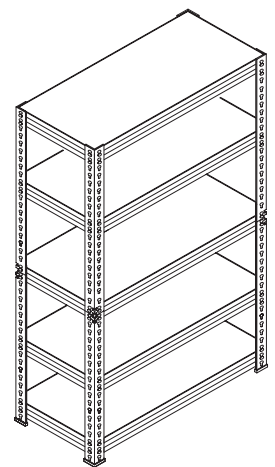

Place the MDF boards in the shelves. Ensure that they are sitting flush against the edge of the shelf brackets.

WARRANTY CONDITIONS

Any claim under this warranty must be made within 1 year of the date of purchase of the product. To make a claim under the warranty, take the product (with proof of purchase) to any Bunnings store (see www.bunnings.com.au for store locations). Romak Hardware Distributors Pty Ltd bears reasonable, direct, expenses of claiming under the warranty. You may submit details and proof to our store for consideration. The warranty covers manufacturer defects in materials, workmanship and finish under normal use. This warranty is provided in addition to other rights and remedies you may have under law: our goods come with guarantees which cannot be excluded under the Australian Consumer Law. You are entitled to replacement or refund for a major failure and compensation for other reasonably foreseeable loss or damage. You are also entitled to have the goods repaired or replaced if the goods fail to be of acceptable quality and the failure does not amount to a major failure. The warranty excludes damage resulting from product misuse or product neglect. The warranty covers domestic use only and does not apply to commercial applications. This warranty is given by Romak Hardware Distributors Pty Ltd, ABN 15489950457, 177-181 Atlantic Drive, Keysborough Vic 3173, (03) 9795-6789. E-mail: sales@romak.com.au. New Zealand customers please contact HARC0 (Harkness & Young Ltd), 9 27 64071, Email: sales@harknessyoung.co.nz. 'Romak' is a TM. © Romak. Suitable for model number 90013.