

# INSTALL GUIDE

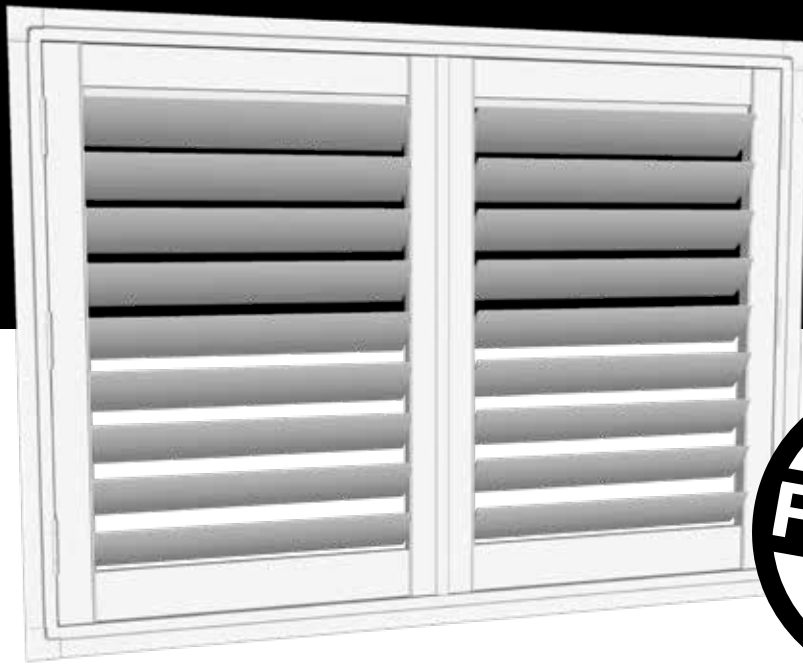

## PACK CONTENTS

- Adjustable outer frame
- 4 x frame corner covers
- Multi Tool (Allen Key / Phillips Head Screwdriver)
- Screws (Phillips Head ⊕)
- Plantation Shutter Panel(s)
- Hinge Pins

Optional tools if required

**Not Included / Sold Separately**

- Cordless Drill
- 2mm Drill Bit

**Frame Screw**



**Hinge Locking Screw**



Check out the Install Video at [easy-as.com.au](http://easy-as.com.au)



# STEP 1

- On a soft surface, lay out the adjustable frame, on the floor, in front of the window with hinges pointing toward you
- Using the labels on each frame, lay out the adjustable frame in the following sequence, as shown in figure **1(A)**:  
T – Top, L – Left, B – Bottom, R – Right

NOTE: Hinge pin 'holes' need to be in an upward position.

**1(A)**

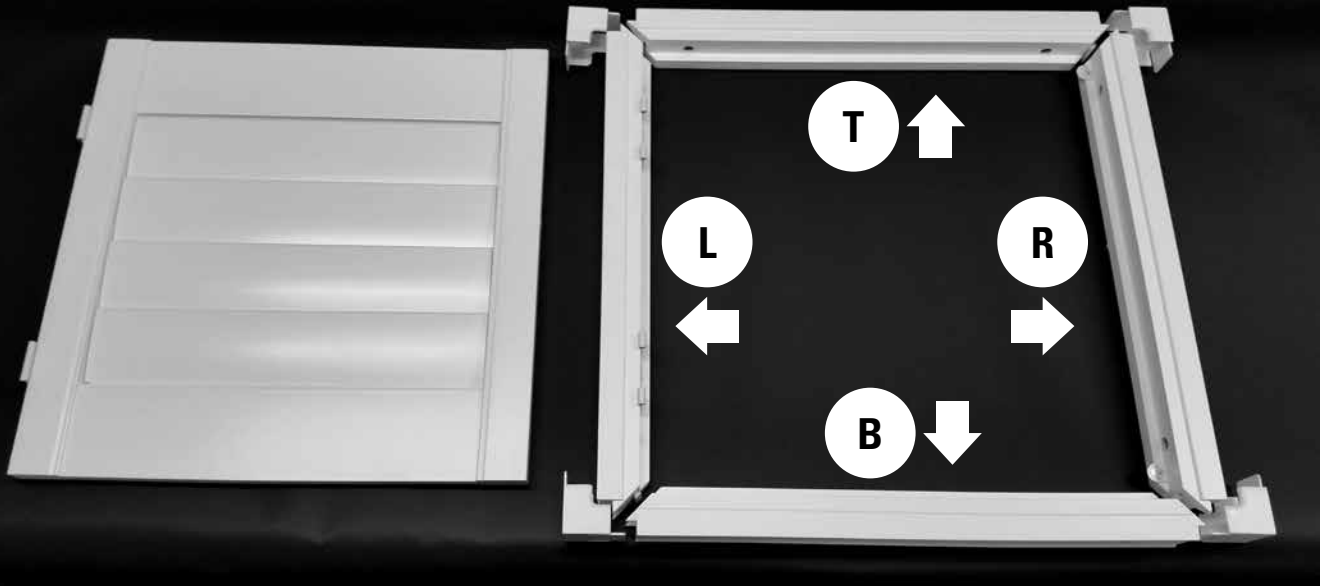

# STEP 2

- Assemble the adjustable frame corners by sliding the locking key into position at the back of the frame, as shown in figure **2(A)**
- Clip the corner covers onto the adjustable frame, as shown in figure **2(B)**

NOTE: These images are showing the back face of the shutter.

**2(A)**

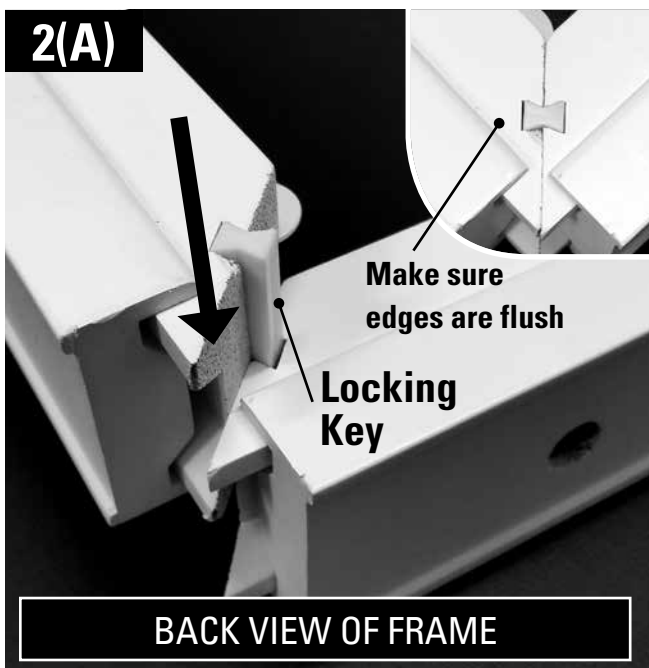

**2(B)**

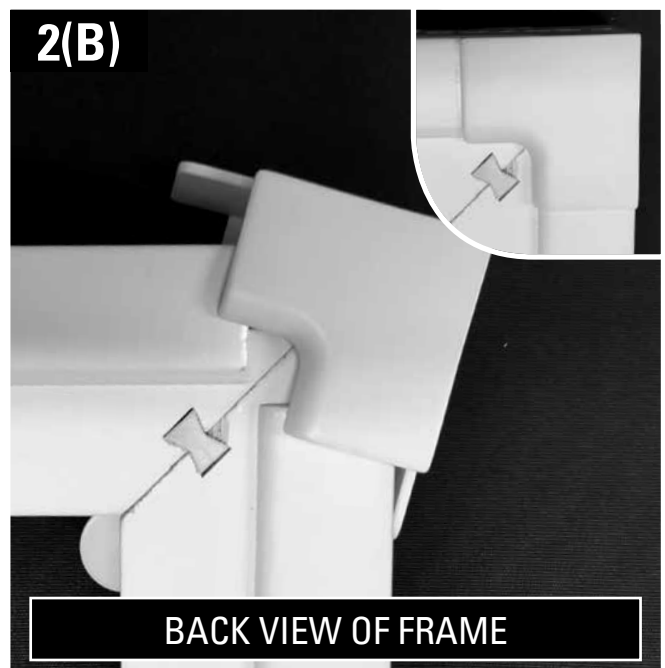



# STEP 3

- Insert the adjustable frame into the window reveal as shown in figure 3(A).
- Using the Allen key, adjust the frame evenly by turning each adjuster 2 full turns at a time in an anticlockwise direction to expand frame into the opening. Adjust each side adjuster evenly until a tight, square fit, is achieved as shown in figure 3(B)
- Using the screws provided, secure the frame in place by inserting one screw into each side of the frame. Each screw should be inserted through the hole in the centre of each adjuster, as shown in figure 3(C)

NOTE: Hinges must be facing toward you when mounting.

NOTE: At this stage only use 1 screw on each side & insert through the adjusters closest to the centre of each side.

3(A)

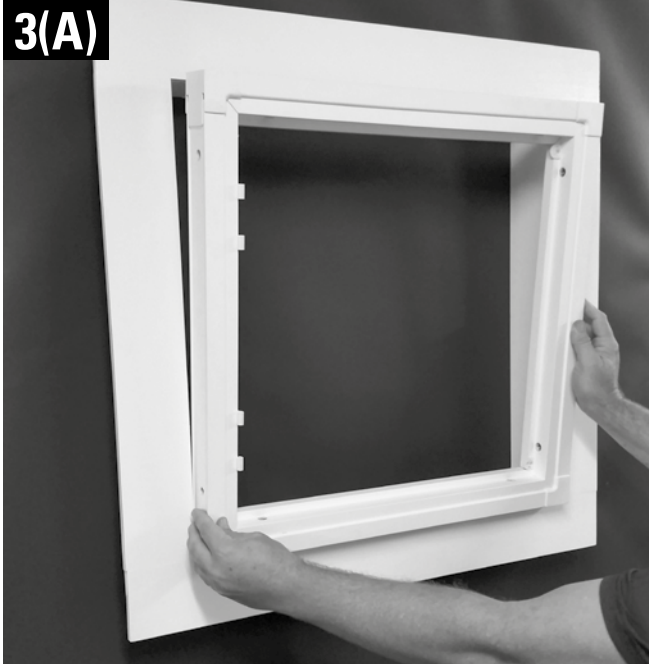

3(B)

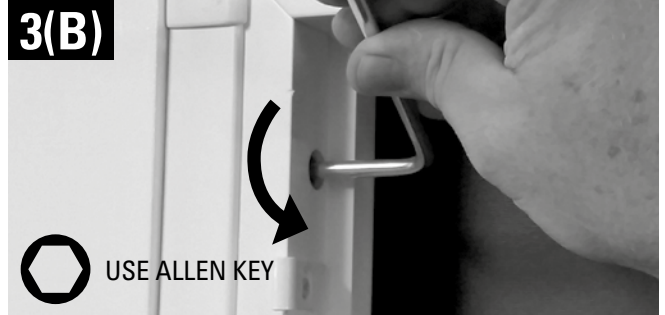

3(C)

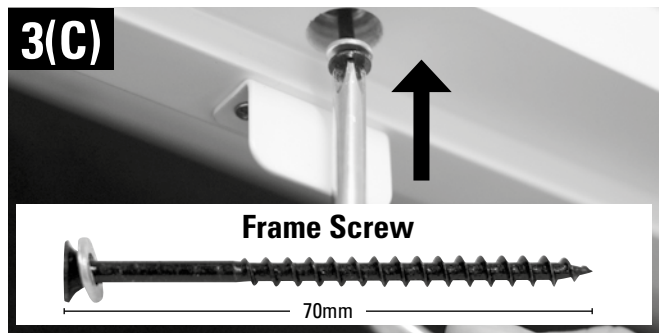

# STEP 4

- Insert the LEFT shutter panel first onto the hinges and secure with the hinge pins, as shown in figure 4 (A)
- Repeat this step for all shutter panels
- Open and close the shutter panel(s) to check fit as shown in figure 4(B)
- Using the Allen key, make small adjustments to the adjustable frame, to align the doors if required

NOTE: Take care while placing hinge pins to avoid damage and scratches.

NOTE: Shutters with multiple panels will be numbered Left to Right (1, 2...etc)

4(A)

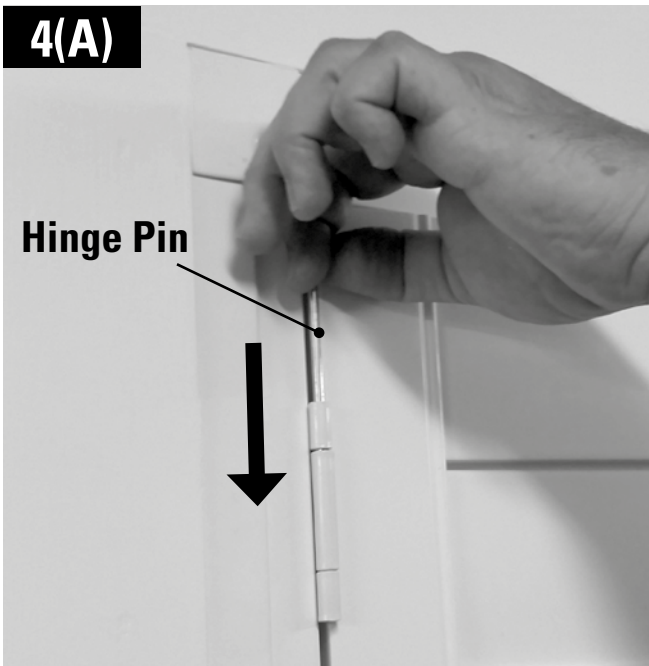

4(B)





# STEP 5

- Using the screws provided, secure the adjustable frame, (Top, Bottom, Left and Right) by fixing the remaining screws permanently into the window jamb, as shown in figure **5(A)**
- Once complete, place white tabs (supplied) over adjusters/screws as shown in figure **5(B)**
- Screw in the remaining 'Hinge locking' screws in place **5(C)**

Secure frame with remaining screws

White adhesive tabs

Hinge locking screw

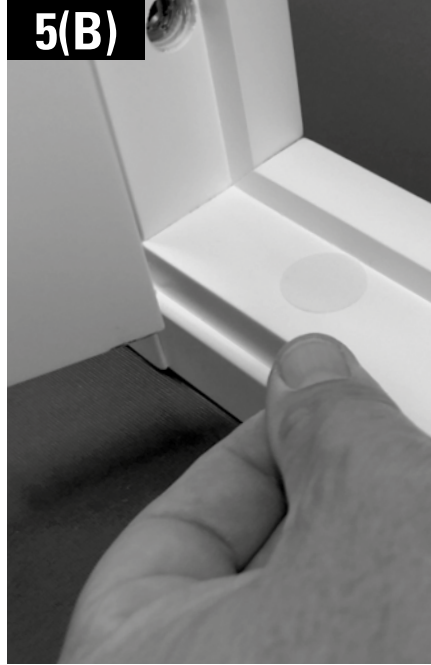

Check out the Install Video at  
**[easy-as.com.au](http://easy-as.com.au)**

