



CTR164TC Series  
CTR164EC Series  
CTR164NC Series  
CTR164DC Series  
CTR164AC Series  
CTR164KC Series

# Ceramic Glass Hob

## user manual

imagine the possibilities

ENGLISH

Thank you for purchasing this Samsung product.

**SAMSUNG**















# using this manual

Please take the time to read this owner's manual, paying particular attention to the safety information contained in the following section, before using your appliance. Keep this manual for future reference. If transferring ownership of the appliance, please remember to pass the manual on to the new owner.

## IMPORTANT SAFETY SYMBOLS AND PRECAUTIONS.

The following symbols are used in the text of this Owner's Manual :

 <b>WARNING</b>	Hazards or unsafe practices that may result in <b>severe personal injury or death.</b>
 <b>CAUTION</b>	Hazards or unsafe practices that may result in <b>minor personal injury or property damage.</b>
 <b>CAUTION</b>	To reduce the risk of fire, explosion, electric shock, or personal injury when using your hob, follow these basic safety precaution
	Do NOT attempt.
	Do NOT disassemble.
	Do NOT touch.
	Follow directions explicitly.
	Unplug the power plug from the wall socket.
	Make sure the machine is grounded to prevent electric shock.
	Call the service center for help.
	Note
	Important



# safety instructions

The safety aspects of this appliance comply with all accepted technical and safety standards. However, as manufacturers we also believe it is our responsibility to familiarize you with the following safety instructions.



## **ELECTRICAL SAFETY**

Be sure the appliance is properly installed and grounded by a qualified technician.

The appliance should be serviced only by qualified service personnel. Repairs carried out by unqualified individuals may cause injury or serious malfunction. If your appliance is in need of repair, contact your local service centre. Failure to follow these instructions may result in damage and void the warranty.

Flush - mounted appliances may be operated only after they have been installed in cabinets and workplaces that conform to the relevant standards. This ensures sufficient protection against contact for electrical units as required by the essential safety standards.

If your appliance malfunctions or if fractures, cracks or splits appear:

- switch off all cooking zones;
- disconnect the hob from the mains supply; and
- contact your local service centre.



## **CHILD SAFETY**

This appliance is not intended for use by young children or infirm persons without the adequate supervision of a responsible adult.

Young children should be supervised to ensure that they do not play with the appliance.

The cooking zones will become hot when you cook. Always keep small children away from the appliance.



## **WARNING SAFETY DURING USE**

---

This appliance is to be used only for normal cooking and frying in the home. It is not designed for commercial or industrial use.

Never use the hob for heating the room.

Take care when plugging electrical appliances into mains sockets near the hob. Mains leads must not come into contact with the hob.

Overheated fat and oil can catch fire quickly. Never leave surface units unattended when preparing foods in fat or oil, for example, when cooking chips.

Turn the cooking zones off after use.

Always keep the control panels clean and dry.

Never place combustible items on the hob. It may cause fire.

Do not use the hob to heat aluminium foil, products wrapped in aluminium foil or frozen foods packaged in aluminium cookware.

There is the risk of burns from the appliance if used carelessly.

Cables from electrical appliances must not touch the hot surface of the hob or hot cookware.

Do not use the hob to dry clothes.

Never store flammable materials such as aerosols and detergents in draws or cupboards under the hob.

**WARNING :** Users with Pacemakers and Active Heart Implants must keep their upper body at a minimum distance of 30cm from induction cooking zones when turned on. If in doubt, you should consult the manufacturer of your device or your doctor.

## **WARNING SAFETY WHEN CLEANING**

---

Always turn the appliance off before cleaning.

For safety reasons do not clean the appliance with a steam jet or high - pressure cleaner.

Clean the hob in accordance with the cleaning and care instructions contained in this manual.





WARNING

## SEVERE WARNING SIGNS FOR INSTALLATION

- ★ The installation of this appliance must be performed by a qualified hob service technician trained by the manufacturer. Please see the section "Installing your Hob".

Plug the power cord into the proper wall socket or higher and use the socket for this appliance only. Plug the power plug into the wall socket firmly. In addition, do not use an extension cord.

- Failure to do so and sharing a wall socket with other appliances using a power strip or extending the power cord may result in electric shock or fire.
- Do not use an electric transformer. It may result in electric shock or fire.

The installation of this appliance must be performed by a qualified technician or service company.

- Failing to do so may result in electric shock, fire, an explosion, problems with the product, or injury.

Appliance should allow to disconnection of the appliance from the supply after installation.

The disconnection may be achieved by having the plug accessible or by incorporating a switch in the fixed wiring in accordance with the wiring rules.

- ☐ Do not install this appliance near a heater, inflammable material.

Do not install this appliance in a humid, oily or dusty location, in a location exposed to direct sunlight and water (rain drops).

Do not install this appliance in a location where gas may leak.

- This may result in electric shock or fire.

The appliance is not intended for installing in road vehicles, caravans and similar vehicles etc.



- ☐ This appliance must be properly grounded.

Do not ground the appliance to a gas pipe, plastic water pipe, or telephone line.

- This may result in electric shock, fire, an explosion, or problems with the product.
- Never plug the power cord into a socket that is not grounded correctly and make sure that it is in accordance with local and national codes.



CAUTION

## CAUTION SIGNS FOR INSTALLATION

- ★ This appliance should be positioned in such a way that it is accessible to the power plug.

- Failure to do so may result in electric shock or fire due to electric leakage.

Install your appliance on a level and hard floor that can support its weight.

- Failure to do so may result in abnormal vibrations, noise, or problems with the product.

Install the appliance while maintaining the proper distance from the wall.

- Failure to do so may result in fire due to overheating.

The minimum height of free space necessary above the top surface of the hob



WARNING

## SEVERE WARNING SIGNS FOR ELECTRIC

- ★ Remove all foreign substances such as dust or water from the power plug terminals and contact points using a dry cloth on a regular basis.

- Unplug the power plug and clean it with a dry cloth.
- Failure to do so may result in electric shock or fire.





- ★ Plug the power plug into the wall socket in the right direction so that the cord runs towards the floor.
  - If you plug the power plug into the socket in the opposite direction, the electric wires within the cable may be damaged and this may result in electric shock or fire.

- ☒ Plug the power plug into the wall socket firmly. Do not use a damaged power plug, damaged power cord or loose wall socket.
  - This may result in electric shock or fire.Do not pull or excessively bend the power cord.  
Do not twist or tie the power cord.  
Do not hook the power cord over a metal object, place a heavy object on the power cord, insert the power cord between objects, or push the power cord into the space behind the appliance.
  - This may result in electric shock or fire.Do not pull the power cord, when unplugging the power plug.
  - Unplug the power plug by holding the plug.
  - Failure to do so may result in electric shock or fire.

- ☒ When the appliance or the cord is damaged, contact your nearest service centre.



CAUTION

## CAUTION SIGNS FOR ELECTRIC

- ☒ Unplug the power plug when the appliance is not being used for long periods of time or during a thunder/lightning storm.
  - Failure to do so may result in electric shock or fire.Unplug the power plug when the appliance is not being used for long periods of time or during a thunder/lightning storm.
  - Failure to do so may result in electric shock or fire.



WARNING

## SEVERE WARNING SIGNS FOR USING

- ★ In the event of a gas leak (such as propane gas, LP gas, etc.), ventilate immediately without touching the power plug. Do not touch the appliance or power cord.
  - Do not use a ventilating fan.
  - A spark may result in an explosion or fire.

During use the appliance becomes hot. Care should be taken to avoid touching heating elements inside the hob.

ALWAYS use hob gloves when removing a dish from the hob to avoid unintentional burn.

**WARNING :** The contents of feeding bottles and baby food jars shall be stirred or shaken and the temperature checked before consumption, in order to avoid burns.

If the supply cord is damaged, it must be replaced by the manufacturer, its service agent or similarly qualified persons in order to avoid a hazard.

Children should be supervised to ensure that they do not play with the appliance

**WARNING :** Only allow children to use the hob without supervision when adequate instructions have been given so that the child is able to use the hob in a safe way and understands the hazards of improper use.

## 6\_ safety instructions





- ★ The appliance is not intended for use by persons (including children) with reduced physical, sensory or mental capabilities, or lack of experience and knowledge, unless they have been given supervision or instruction concerning use of the appliance by a person responsible for their safety.

**WARNING :** Accessible parts may become hot during use. To avoid burns young children should be kept away.

**WARNING :** If the surface is cracked, switch off the appliance to avoid the possibility of electric shock. Do not use your hob until the glass surface has been replaced.

Metallic objects such as knives, forks, spoons and lids should not be placed on the hob surface since they can get hot.

**WARNING :** Ensure that the appliance is switched off before replacing the lamp to avoid the possibility of electric shock.

- ☐ Do not touch the power plug with wet hands.

- This may result in electric shock.

Do not turn the appliance off by unplugging the power plug while an operation is in progress.

- Plugging the power plug into the wall socket again may cause a spark and result in electric shock or fire.

Keep all packaging materials well out of the reach of children, as packaging materials can be dangerous to children.

- If a child places a bag over its head, it may result in suffocation.

- Failing to do so may result in electric shock, burns or injury.

Never use this appliance for purposes other than cooking.

- Failure to do so may result in fire.

Never heat plastic or paper containers and do not use them with the hob function.

- Failure to do so may result in fire.

Do not over-heat food.

- This may result in fire.

Do not heat food wrapped in paper such as magazines or newspaper.

- This may result in fire.

Do not use or place inflammable sprays or objects near the hob.

- This may result in fire or an explosion.

To heat beverages such as coffee, tea, liquor or water or dishes such as curry, soup or stew, use a low power setting and make sure to stir the contents while heating them.

- Using a high power setting **can cause the contents to boil over without warning** and cause serious burns.



- ☒ Do not insert fingers, foreign substances or metal objects such as pins or needles into the inlet, outlet, and holes. If foreign substances are inserted into any of these holes, unplug the power plug from the wall socket and contact your product provider or nearest service centre.

- Failure to do so may result in electric shock or injury.

NEVER fill the container to the top and choose a container that is wider at the top than at the bottom to prevent the liquid from boiling over. Bottles with narrow necks may also explode if overheated.

NEVER heat a baby's bottle with the teat on, as the bottle may explode if overheated.

Do not immerse the power cable or plug in water and keep the power cable away from heated surfaces.

Do not operate this appliance if it has a damaged power cable or plug.

**WARNING :** Liquids and other foods must not be heated in sealed containers since they are liable to explode.

- 
- ☒ Do not attempt to repair, disassemble, or modify the appliance yourself.

- Do not use any fuse (such as copper, steel wire, etc.) other than the standard fuse.
- When repairing or reinstalling the appliance is required, contact your nearest service centre.
- Failure to do so may result in electric shock, fire, problems with the product, or injury.

- 
- ☒ If any foreign substance such as water has entered the appliance, unplug the power plug and contact your nearest service centre.

- Failure to do so may result in electric shock or fire.

- 
- ☒ If the appliance is flooded, please contact your nearest service centre.

- Failure to do so may result in electric shock or fire.

If the appliance generates a strange noise, a burning smell or smoke, unplug the power plug immediately and contact your nearest service centre.

- Failing to do so may result in electric shock or fire.



CAUTION

## CAUTION SIGNS FOR USING

- 
- ★ Take care as beverages or food may be very hot after heating.

- Especially when feeding a child, check that it has cooled sufficiently.

Take care when heating liquids such as water or other beverages.

- Avoid using a slippery container with a narrow neck.
- Failing to do so may result in an abrupt overflow of the contents and cause burns.

Do not hold food or any part thereof during or immediately after cooking.

- Use cooking gloves because it may be very hot and you could burn yourself.

When the surface is cracked, turn the power switch of the appliance off.

- Failure to do so may result in electric shock.







-  Small amounts of food require shorter cooking or heating time.

If normal times are allowed they may overheat and burn.

Children should be supervised to ensure that they do not play with the appliance.

Any spillage should be removed from the lid before opening and the hob surface should be allowed to cool before closing the lid (Model which has lid only).

-  Do not stand on top of the appliance or place objects (such as laundry, hob cover, lighted candles, lighted cigarettes, dishes, chemicals, metal objects, etc.) on the appliance.
- This may result in electric shock, fire, problems with the product, or injury.
- Do not operate the appliance with wet hands.
- This may result in electric shock.
- Do not spray volatile material such as insecticide onto the surface of the appliance.
- As well as being harmful to humans, it may also result in electric shock, fire or problems with the product.
- Do not place the appliance over a fragile object such as a sink or glass object.
- This may result in damage to the sink or glass object.
- Take care when removing the wrapping from food that has just been taken out of the appliance.
- If the food is hot, hot steam may be emitted abruptly when removing the wrapping and you may burn yourself.
- Do not unplug the appliance by pulling at the power cord, always grip plug firmly and pull straight out from the outlet.
- Damage to the cord may cause short-circuit, fire and/or electric shock
- Appliances are not intended to be operated by means of an external timer or separate remote-control system.
- Do not stare at the hob elements (Model which was installed halogen lamp only).
- After use, switch off the hob element by its control and do not rely on the pan detector (Model which was installed pan detector only).



WARNING

## SEVERE WARNING SIGNS FOR CLEANING

-  Do not clean the appliance by spraying water directly onto it.  
Do not use benzene, thinner or alcohol to clean the appliance.
- This may result in discoloration, deformation, damage, electric shock or fire.
- Before cleaning or performing maintenance, unplug the appliance from the wall socket.
- Failure to do so may result in electric shock or fire.
- For your safety, do not use high-pressure water cleaners or steam jet cleaners.



WARNING

## CAUTION SIGNS FOR CLEANING



The hob should be cleaned regularly and any food deposits removed.

Failure to maintain the hob in a clean condition could lead to deterioration of the surface that could adversely affect the life of the appliance and possibly result in a hazardous situation.



Take care not to hurt yourself when cleaning the appliance (external/internal).

- You may hurt yourself on the sharp edges of the appliance.

Do not clean the appliance with a steam cleaner.

- This may result in corrosion.

# disposal instructions



WARNING

## DISPOSING OF THE PACKAGING MATERIAL

All materials used to package the appliance are fully recyclable. Sheet and hard foam parts are appropriately marked. Please dispose of packaging materials and old appliances with due regard to safety and the environment.



WARNING

## PROPER DISPOSAL OF YOUR OLD APPLIANCE

**WARNING :** Before disposing of your old appliance, make it inoperable so that it cannot be a source of danger.

To do this, have a qualified technician disconnect the appliance from the mains supply and remove the mains lead.

The appliance may not be disposed of in the household rubbish.

Information about collection dates and public refuse disposal sites is available from your local refuse department or council.





# contents

## **INSTALLING THE HOB**

12

- 12 Safety instructions for the installer
- 13 Connecting to the mains power supply
- 14 Installing into the countertop

## **PARTS AND FEATURES**

16

- 16 Cooking zones
- 16 Control panel
- 17 Components
- 17 The key features of your appliance
- 18 Safety shutoff
- 18 Residual heat indicator
- 18 Temperature detection
- 19 Initial cleaning

## **BEFORE YOU BEGIN**

19

## **HOB USE**

20

- 20 Using suitable cookware
- 21 Using the touch control sensors
- 21 Switching the appliance on
- 22 Select cooking zone and heat setting
- 23 Switching the appliance off
- 23 Using the casserole cooking zone
- 24 Using the double cooking zone
- 25 Switching a cooking zone off
- 25 Using the child safety lock
- 26 Timer
- 27 Countdown timer
- 28 Locking and unlocking the control panel
- 28 Suggested settings for cooking specific foods
- 29 Hob
- 30 Hob frame (option)
- 30 To avoid damaging your appliance

## **CLEANING AND CARE**

29

## **WARRANTY AND SERVICE**

31

- 31 FAQs and troubleshooting
- 32 Service

## **TECHNICAL DATA**

33

- 33 Technical data
- 33 Cooking rings

## **APPENDIX**

33

- 33 Model name & serial number



# installing the hob

 Be sure the new appliance is installed and grounded only by qualified personnel.  
**WARNING** Please observe this instruction. The warranty will not cover any damage that may occur as a result of improper installation.  
Technical data is provided at the end of this manual.

## SAFETY INSTRUCTIONS FOR THE INSTALLER

- A device must be provided in the electrical installation that allows the appliance to be disconnected from the mains at all poles with a contact opening width of at least 3 mm. Suitable isolation devices include line protecting cut - outs, fuses (screw type fuses are to be removed from the holder), earth leakage trips and contactors.
- With respect to fire protection, this appliance corresponds to EN 60335 - 2 - 6. This type of appliance may be installed with a high cupboard or wall on one side.
- Drawers may not be fitted underneath the hob.
- The installation must guarantee shock protection.
- The kitchen unit in which the appliance is fitted must satisfy the stability requirements of DIN 68930.
- For protection against moisture, all cut surfaces are to be sealed with a suitable sealant.
- On tiled work surfaces, the joints in the area where the hob sits must be completely filled with grout.
- On natural, artificial stone, or ceramic tops, the snap action springs must be bonded in place with a suitable artificial resin or mixed adhesive.
- Ensure that the seal is correctly seated against the work surface without any gaps. Additional silicon sealant must not be applied; this would make removal more difficult when servicing.
- The hob must be pressed out from below when removed.
- A board is to be installed underneath the hob.

 The surface temperature on the underside of the electric hob may exceeds 95°C.  
**CAUTION** To avoid hazard, under bench access must be restricted.



## CONNECTING TO THE MAINS POWER SUPPLY

Before connecting, check that the nominal voltage of the appliance, that is, the voltage stated on the rating plate, corresponds to the available supply voltage. The rating plate is located on the lower casing of the hob.

**⚠ WARNING Shut off power to circuit before connecting wires to circuit.**

The heating element voltage is AC 230 V~. The appliance also works perfectly on networks with AC 220 V~ or AC 240 V~.

The hob is to be connected to the mains using a device that allows the appliance to be disconnected from the mains at all poles with a contact opening width of at least 3 mm, eg. automatic line protecting cut - out, earth leakage trips or fuse.

A type H05RN - F cable or one of a higher grade must be used as the mains connecting cable.

	Rated current of appliance (A)	Nominal cross-sectional area (mm <sup>2</sup> )
1N~	> 25 and ≤ 32	≥ 2.5
2N~	> 10 and ≤ 16	≥ 1.5

The connection must be carried out as shown in the diagram. The connecting links should be fitted according to the appropriate connection diagram.

The earth lead is connected to terminal. The earth lead must be longer than leads carrying electric current.

**⚠ WARNING The cable connections must be made in accordance with regulations and the terminal screws tightened securely.**

The connecting cable is to be secured with the mains cable cleat and the covering closed by pressing firmly (locking into place). Before switching on for the first time, any protective foil or stickers must be removed from the ceramic glass surface.

**⚠ WARNING** Once the hob is connected to the mains supply, check that all cooking zones are ready for use by briefly switching each on in turn at the maximum setting with suitable cookware.

**🔒** When the hob is powered on for the first time, all displays light and the child safety lock is activated.

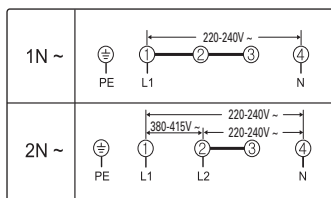

< IN ~ >

L: Brown

N: Blue

PE: Green

**⚠ WARNING** Pay attention (conformity) to phase and neutral allocation of house connection and appliance (connection schemes); otherwise, components can be damaged. Warranty does not cover damage resulting from improper installation.

**⚠ WARNING** If the supply cord is damaged, it must be replaced by a special cord or assembly available from the manufacturer or its service agent.





## INSTALLING INTO THE COUNTERTOP



Make a note of the serial number on the appliance rating plate prior to installation. This number will be required in the case of requests for service and is no longer accessible after installation, as it is on the original rating plate on the underside of the appliance.

Pay special attention to the minimum space and clearance requirements.

Secure the brackets at both sides with the provided screws before mounting the hob onto the brackets.

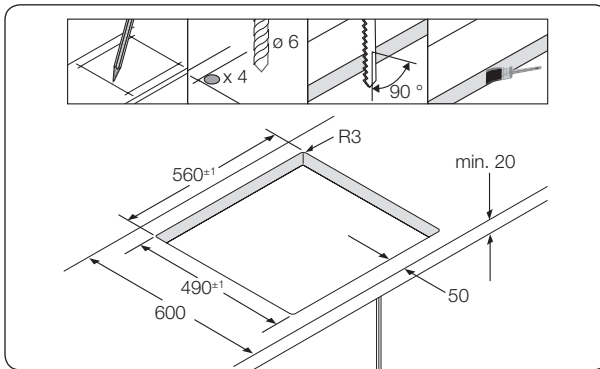
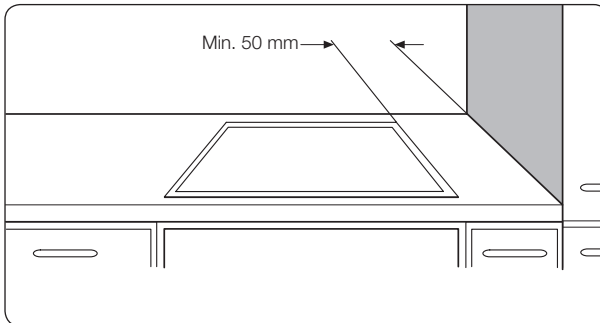



INSTALLING THE HOB

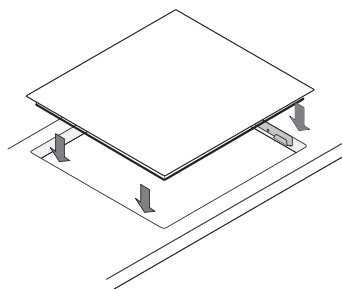
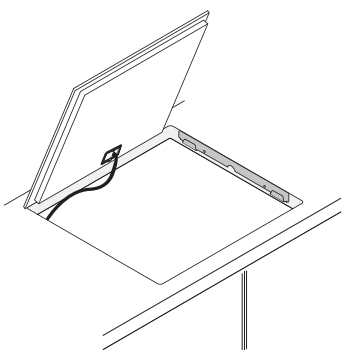
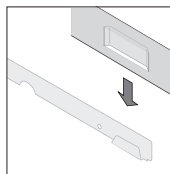
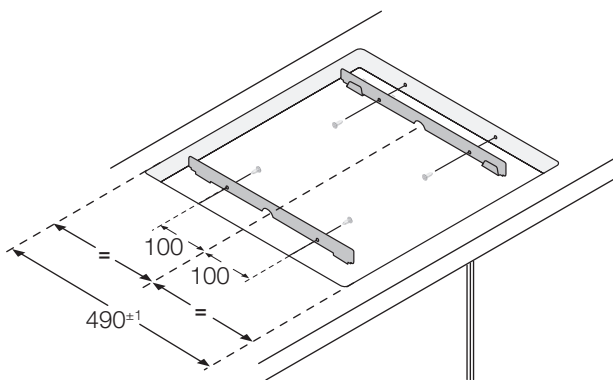
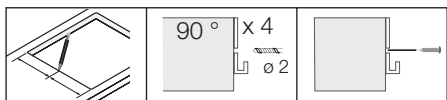

installing the hob \_15





# parts and features

## COOKING ZONES

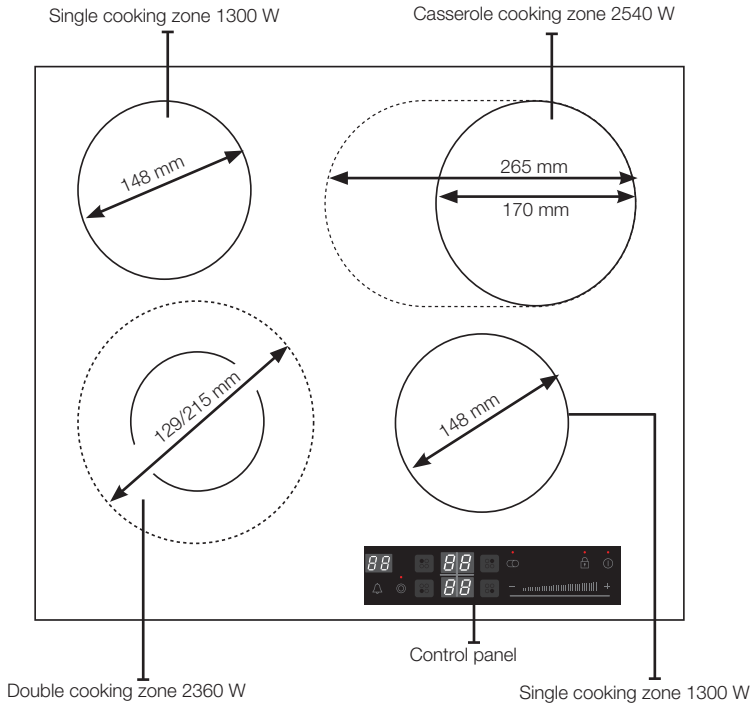

## CONTROL PANEL

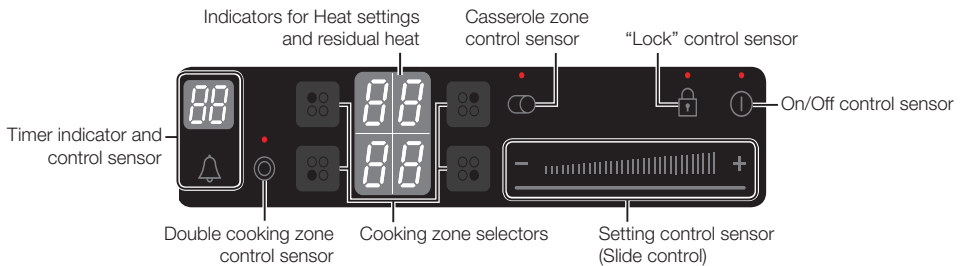



## COMPONENTS

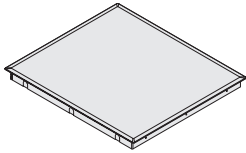

Ceramic Glass Hob

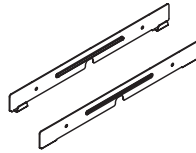



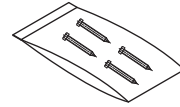



Installation Brackets



Screws

## THE KEY FEATURES OF YOUR APPLIANCE

- **Ceramic glass cooking surface:** The appliance has a ceramic glass cooking surface and four rapid - response cooking zones. The hob's powerful radiant heater elements significantly shorten the amount of time required for the zones to heat up.
- **Touch control sensors:** Your appliance is operated using touch control sensors.
- **Easy cleaning:** The advantage of the ceramic glass cooking surface and the control sensors is their accessibility for cleaning. The smooth, flat surface is easy to clean.
- **On/Off sensor:** The "On/Off" control sensor provides the appliance with a separate mains switch. Touching this sensor switches the power supply on or off completely.
- **Control and function indicators:** Digital displays and indicator lights provide information about settings and activated functions, as well as the presence of residual heat in the various cooking zones.
- **Safety shutoff:** A safety shutoff ensures that cooking zones switch off automatically after a period of time if the setting has not been changed.
- **Residual heat indicator:** An icon for residual heat appears in the display if the cooking zone is so hot that there is a risk of burning.
- **Double cooking zone:** The cooking surface features a double cooking zone. This provides the appliance with a cooking zone of variable size, for instance, for when cooking with smaller cookware. This allows savings in energy.
- **Multipurpose cooking zone:** The hob is equipped with a multipurpose / casserole cooking zone. Depending on the setting, it can be used as a round or oval cooking zone, for example, for when cooking with oval casseroles or for keeping dishes or food warm.
- **Digital displays:** The four display fields are assigned to the four cooking zones. They show the following information:
  -  the appliance has been switched on,
  -  selected heat settings,
  -  residual heat,
  -  the child lock is activated
  -  error message, the sensor has been touched for longer than 10 seconds.
  -  error message, when the hob is overheated because of abnormal operation. (example : operation with empty cookware)



## SAFETY SHUTOFF

If one of the cooking zones is not switched off or the heat setting is not adjusted after an extended period of time, that particular cooking zone will automatically switch itself off.

Any residual warmth will be indicated with **H** (for “hot”) in the digital displays corresponding to the particular cooking zones.

The cooking zones switch themselves off at the following times.

Heat setting	Switch off
1-2	After 6 hours
3-4	After 5 hours
5-6	After 3 hours
7-9	After 1 hours

-  If the Hob is overheated because of abnormal operation, **H E** will be displayed. And the Hob will be switched off.
-  Should one or more of the cooking zones switch off before the indicated time has elapsed, see the section “Troubleshooting”.

### Other reasons why a cooking zone will switch itself off

All cooking zones will immediately switch themselves off if liquid boils over and lands on the control panel.

The automatic shutoff will also be activated if you place a damp cloth on the control panel. In both of these instances, the appliance will need to be switched on again using the main **On/Off control**  sensor after the liquid or the cloth has been removed.

## RESIDUAL HEAT INDICATOR

When an individual cooking zone or the hob is turned off, the presence of residual heat is shown with an **H** (for “hot”) in the digital display of the appropriate cooking zones. Even after the cooking zone has been switched off, the residual heat indicator goes out only after the cooking zone has cooled.

You can use the residual heat for thawing or keeping food warm.

 **WARNING** As long as the residual heat indicator is illuminated, there is a risk of burns.

 **WARNING** If the power supply is interrupted, the **H** symbol will go out and information about residual heat will no longer be available. However, it may still be possible to burn yourself. This can be avoided by always taking care when near the hob.

## TEMPERATURE DETECTION

If for any reason the temperatures on any of the cooking zones were to exceed the safety levels, should this happen then the cooking zone will automatically reduce to a lower power level.



# before you begin

## INITIAL CLEANING

Wipe the ceramic glass surface with a damp cloth and ceramic cooktop glass cleaner.



WARNING

Do not use caustic or abrasive cleaners. The surface could be damaged.

BEFORE YOU BEGIN

# hob use

## USING SUITABLE COOKWARE

Better pans produce better results.

- You can recognise good pans by their bases. The base should be as thick and flat as possible.
- When buying new pans, pay particular attention to the diameter of the base. Manufacturers often give only the diameter of the upper rim.
- Pots with aluminium or copper bases can cause metallic discolouration on the ceramic glass surface. The discolouration is very difficult or impossible to remove.
- Do not use pans which have damaged bases with rough edges or burrs. Permanent scratching can occur if these pan are slid across the surface.
- When cold, pan bases are normally bowed slightly inwards (concave). They should never be bowed outwards (convex).
- If you wish to use a special type of pan, for example, a pressure cooker, a simmering pan, or a wok, please observe the manufacturer's instructions.

## Energy saving tips

 You can save valuable energy by observing the following points.

- Always position pots and pans before switching on the cooking zone.
- Dirty cooking zones and pan bases increase power consumption.
- When possible, position the lids firmly on the pots and pans to cover completely.
- Switch the cooking zones off before the end of the cooking time to use the residual heat for keeping foods warm or for thawing.
- The base of the pan should be the same size as the cooking zone.
- Using a pressure cooker reduces cooking times by up to 50 %.



Right!

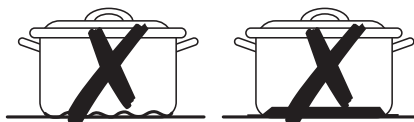

Wrong!

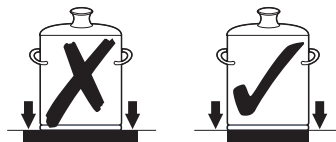
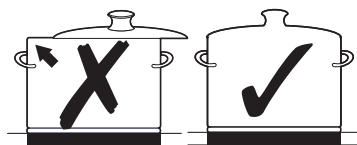







## USING THE TOUCH CONTROL SENSORS



To operate the touch control sensors, touch the desired panel with the tip of your pointed finger until the relevant displays illuminate or go out, or until the desired function is activated.

Ensure that you are touching only one sensor panel when operating the appliance. If your finger is too flat on the panel, an adjacent sensor may be actuated as well.

## SWITCHING THE APPLIANCE ON

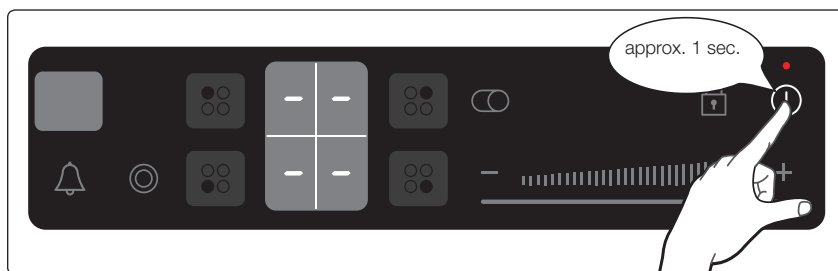
1. Touch the **Lock control**  sensor for approximately 3 seconds.
2. The appliance is switched on using the **On/Off control**  sensor. Touch the **On/Off control**  sensor for 1 second. The digital displays will show .



-  After the **On/Off control**  sensor has been actuated to switch on your appliance, a heat setting must be selected within approximately 10 seconds. Otherwise, the appliance will switch itself off for safety reasons.



## SELECT COOKING ZONE AND HEAT SETTING

1. For selecting the cooking zone, touch the corresponding cooking zone's key.

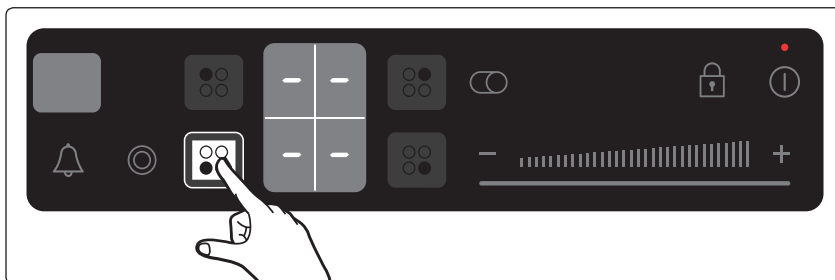

2. For setting and adjusting the power level ( **1** to **9** ) for cooking, touch the **Heat setting selectors** (+ or -).

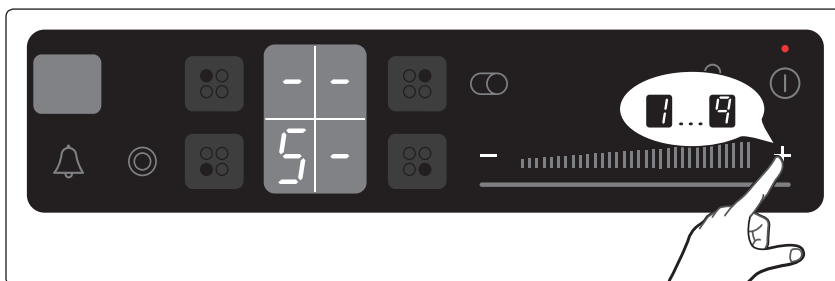

- ✍ For faster adjustment, keep your finger on the **Heat setting selectors** (+ or -) until the required value is obtained.

If more than one sensor is pressed for longer than 10 seconds, **5 E** will show in the heat setting display. To reset, touch the **On/Off control** (ⓘ) sensor.

- ✍ You can use Slide control sensor to adjust the power level.

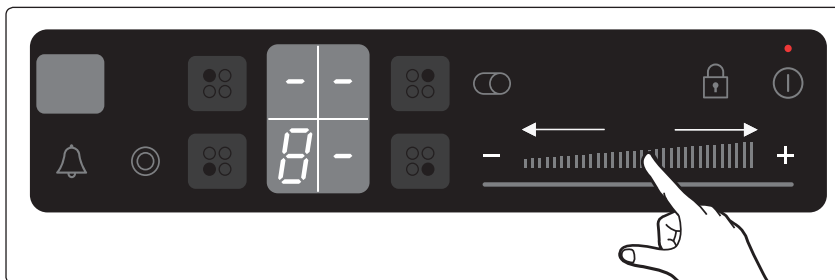



## SWITCHING THE APPLIANCE OFF

To completely switch off the appliance, use the **On/Off control** ① sensor.

Touch the **On/Off control** ① sensor.

- ☞ After switching off a single cooking zone or the entire cooking surface, the presence of residual heat will be indicated in the digital displays of the corresponding cooking zones in the form of an **H** (for “hot”).

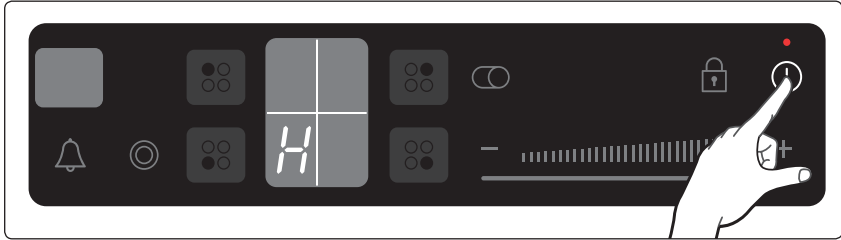

## USING THE CASSEROLE COOKING ZONE

By using the casserole cooking zone, you can switch from the smaller cooking zone to the larger oval cooking zone.

- ☞ You can switch between the two zone settings only if a heat level has already been set for the smaller zone.

1. Select a heat setting.

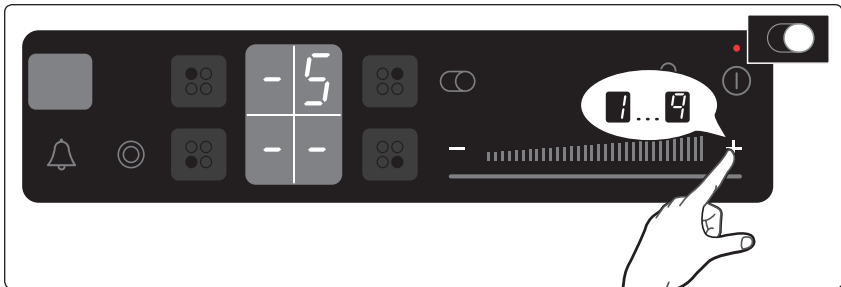

2. To switch the casserole cooking zone on or off, place your finger flat on the “Casserole cooking zone” touch sensor until the indicator light illuminates or extinguishes.

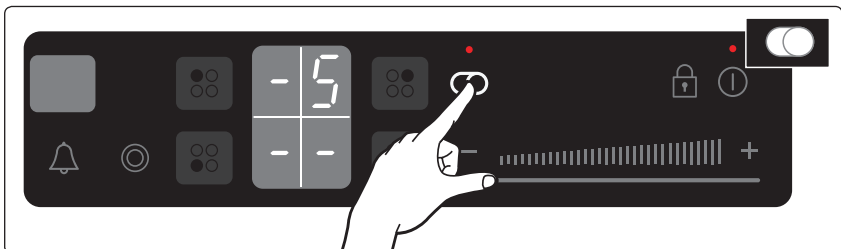

## USING THE DOUBLE COOKING ZONE

By using the double cooking zone, you can alternate between the smaller cooking zone and the larger cooking zone depending on the size of the cookware you are using. Select the setting with the “Double Cooking Zone ☉” control sensor.

 You can switch between the two cooking zones only after a heat setting has been selected for the smaller cooking zone.

1. Select the desired heat setting.

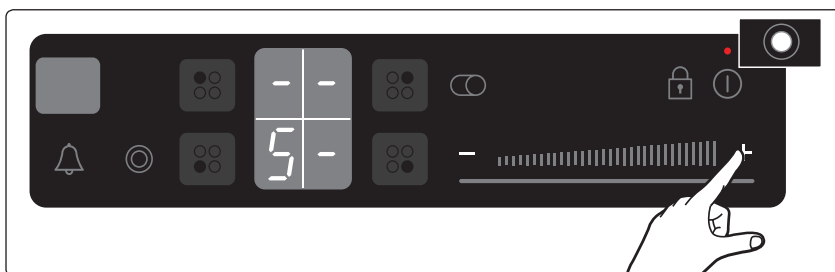

2. Touch the “Double Cooking Zone ☉” control sensor. This will switch on the outer cooking zone. The indicator light will illuminate.

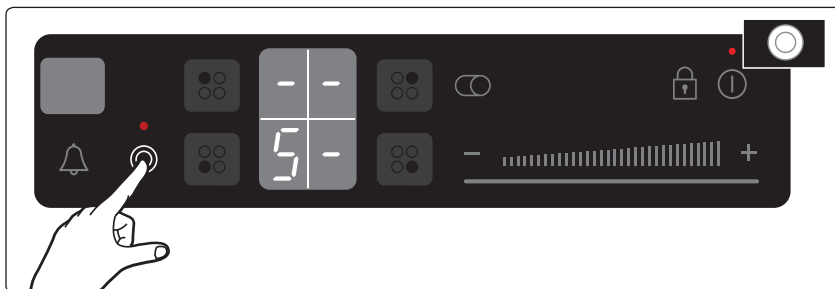

3. To switch the outer cooking zone off, touch the “Double Cooking Zone ☉” control sensor.





## SWITCHING A COOKING ZONE OFF

To switch off a cooking zone, return the setting to **0** by using the control panel's heat setting and touch sensors **0** or **+** **control** sensor.

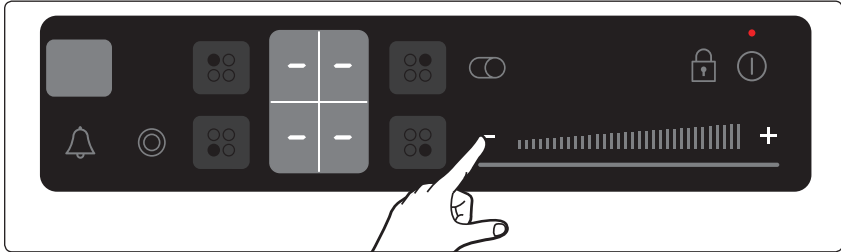

 To switch off more quickly, touch the corresponding cooking zone's key twice.

## USING THE CHILD SAFETY LOCK

You can use the child safety lock to safeguard against unintentionally turning on a cooking zone and activating the cooking surface.

### Switching the child safety lock on

1. Touch the **Lock control**  sensor for approximately 3 seconds. An acoustic signal will sound as confirmation.

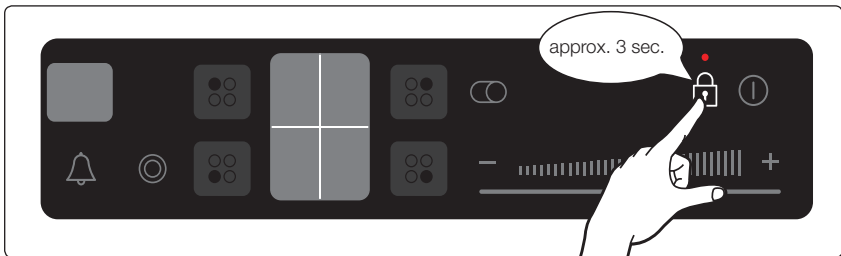

2. Touch **any heat setting control** sensor.  
 will appear in the displays, indicating the child safety lock has been activated.

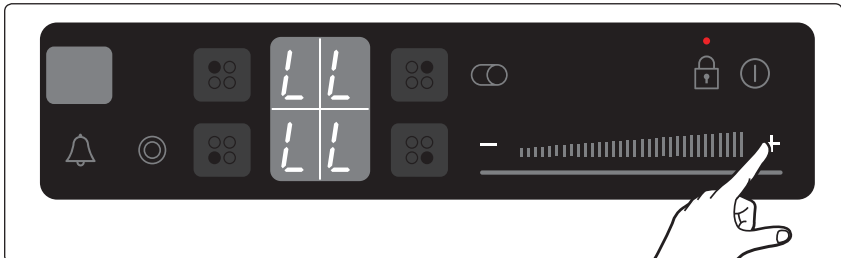



## Switching the child safety lock off

1. Touch the Lock control  sensor for approximately 3 seconds. An acoustic signal will sound as confirmation.

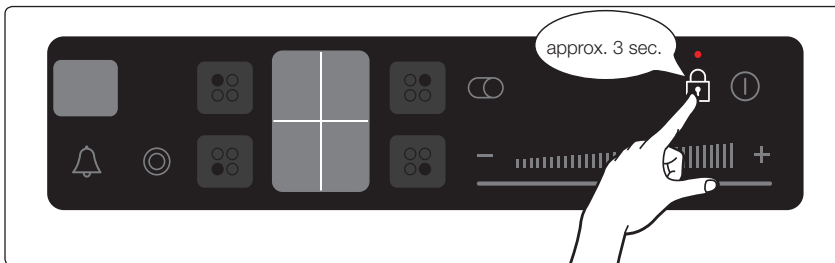

## TIMER

There are two ways to use the timer:

### Using the timer as a safety shutoff

If a specific time is set for a cooking zone, the cooking zone will shut itself off once this period of time has elapsed. This function can be used for multiple cooking zones simultaneously.

### Using the timer to count down

The countdown timer cannot be used if a cooking zone has been switched on.

## Setting the safety shutoff

The cooking zone(s) for which you want to apply the safety shutoff must be switched on.

1. Using the timer's control sensor , select the cooking zone for which the safety shutoff time is to be set.

After the first active cooking zone is selected, touching the timer's control sensor will cause the corresponding indicator to flash slowly.

For example, the front left indicator corresponds to the front left cooking zone.  will appear in the timer display.

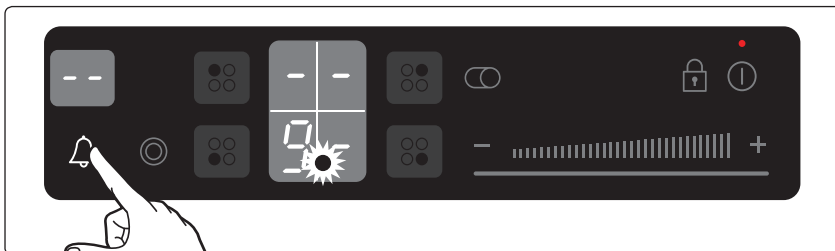

The next active cooking zone is selected by touching the timer's control sensor again .





- Use the **+** or **-** timer setting control sensors to set the desired amount of time, for example, 15 minutes, after which the cooking zone will automatically switch itself off. The safety shutoff is now activated.

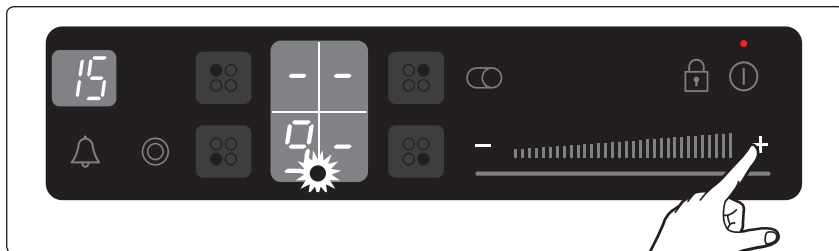

To display the time remaining for any of the cooking zones, use the timer's control sensor . The corresponding control indicator will begin to blink slowly. The settings are reset using the **+** or **-** timer setting control sensors. After the set period of time has elapsed, the cooking zone automatically switches itself off, an acoustic signal sounds as confirmation and the timer display indicates.

- To make the settings more quickly, touch any of the **+** or **-** timer setting control sensors until the desired value is reached.

If the **-** timer setting control sensor is touched first, the time setting will begin at 99 minutes; if the **+** timer setting control sensor is touched first, the time setting will begin at 1 minute.

## COUNTDOWN TIMER

For the countdown timer to be used, the appliance must be switched on but all the cooking zones must be switched off.

- Touch the timer's control sensor .  
**--** will appear in the timer display.
- Set the desired period of time using the **+** or **-** timer setting control sensors.

The countdown timer function is now activated and the remaining time appears in the timer display.

To adjust the remaining time, touch the timer's control sensor and change the setting using the **+** or **-** timer setting control sensors .



## LOCKING AND UNLOCKING THE CONTROL PANEL

At any stage during the cooking process, the control panel, with the exception of the "On/Off" control sensor, can be locked in order to prevent the settings from being changed unintentionally, for example, by wiping over the panel with a cloth.

1. Touch the lock control sensor for approximately 3 seconds. The indicator light in the lock control sensor will illuminate. The control sensors are now locked.

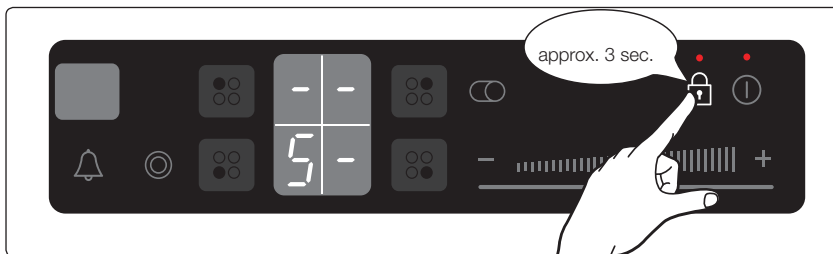



2. To unlock the control sensor, touch the lock control sensor again for approximately 3 seconds. The indicator light in the lock control sensor will extinguish.

## SUGGESTED SETTINGS FOR COOKING SPECIFIC FOODS

The figures in the table below are guidelines. The heat settings required for various cooking methods depend on a number of variables, including the quality of the cookware being used and the type and amount of food being cooked.

Switch Setting	Cooking method	Examples for Use
9	Warming Sautéing Frying	Warming large amounts of liquid, boiling noodles, searing meat, (browning goulash, braising meat)
8	Intensive Frying	Steak, sirloin, hash browns, sausages, pancakes / griddle cakes
7		
6	Frying	Schnitzel / chops, liver, fish, rissoles, fried eggs
5	Boiling	Cooking up to 1.5 l liquid, potatoes, vegetables
4		
3	Steaming Stewing Boiling	Steaming and stewing of small amounts of vegetables, boiling rice and milk dishes
2		
1	Melting	Melting butter, dissolving gelatine, melting chocolate

 The heat settings indicated in the table above are provided only as guidelines for your reference.

 You will need to adjust the heat settings according to specific cookware and foods.

# cleaning and care

## HOB



WARNING

Cleaning agents must not come into contact with a heated ceramic glass surface: All cleaning agents must be removed with adequate amounts of clean water after cleaning because they can have a caustic effect when the surface becomes hot. Do not use any aggressive cleaners such as grill or oven sprays, scouring pads or abrasive pan cleaners.



Clean the ceramic glass surface after each use when it is still warm to the touch. This will prevent spillage from becoming burnt onto the surface. Remove scales, watermarks, fat drippings and metallic discolouration with the use of a commercially available ceramic glass or stainless steel cleaner.

### Light Soiling

1. Wipe the ceramic glass surface with a damp cloth.
2. Rub dry with a clean cloth. Remnants of cleaning agent must not be left on the surface.
3. Thoroughly clean the entire ceramic glass cooking surface once a week with a commercially available ceramic glass or stainless steel cleaner.
4. Wipe the ceramic glass surface using adequate amounts of clean water and rub dry with a clean lint - free cloth.

### Stubborn Soiling

1. To remove food that has boiled over and stubborn splashes, use a glass scraper.
2. Place the glass scraper at an angle to the ceramic glass surface.
3. Remove soiling by scraping with the blade.



Glass scrapers and ceramic glass cleaners are available from specialty retailers.

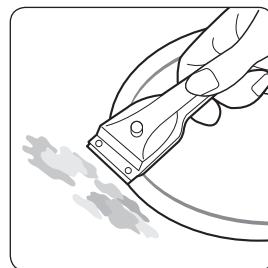



## Problem Dirt

1. Remove burnt-on sugar, melted plastic, aluminium foil or other materials with a glass scraper immediately and while still hot.

 **WARNING** There is a risk of burning yourself when the glass scraper is used on a hot cooking zone:

2. Clean the hob as normal when it has cooled down.  
If the cooking zone on which something has melted has been allowed to cool, warm it up again for cleaning.

 Scratches or dark blemishes on the ceramic glass surface, caused, for example, by a pan with sharp edges, cannot be removed. However, they do not impair the function of the hob.

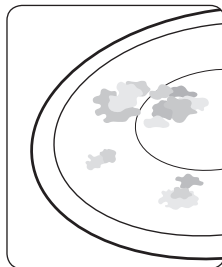

## HOB FRAME (OPTION)

 **WARNING** Do not use vinegar, lemon juice or scale remover on the hob frame; otherwise dull blemishes will appear.

1. Wipe the frame with a damp cloth.
2. Moisten dried debris with a wet cloth. Wipe and rub dry.

## TO AVOID DAMAGING YOUR APPLIANCE

- Do not use the hob as a work surface or for storage.
- Do not operate a cooking zone if there is no pan on the hob or if the pan is empty.
- Ceramic glass is very tough and resistant to temperature shock, but it is not unbreakable.  
It can be damaged by a particularly sharp or hard object dropping onto the hob.
- Do not place pans on the hob frame. Scratching and damage to the finish may occur.
- Avoid spilling acidic liquids, for example, vinegar, lemon juice and descaling agents, onto the hob frame, since such liquids can cause dull spots.
- If sugar or a preparation containing sugar comes into contact with a hot cooking zone and melts, it should be cleaned off immediately with a kitchen scraper while it is still hot. If allowed to cool, it may damage the surface when removed.
- Keep all items and materials that could melt, for example, plastics, aluminium foil and oven foils, away from the ceramic glass surface. If something of this nature melts onto the hob, it must be removed immediately with a scraper.





# warranty and service

## FAQS AND TROUBLESHOOTING

A fault may result from a minor error that you can correct yourself with the help of the following instructions. Do not attempt any further repairs if the following instructions do not help in each specific case.

 **WARNING** Repairs to the appliance are to be performed only by a qualified service technician. Improperly effected repairs may result in considerable risk to the user. If your appliance needs repair, please contact your customer service centre.

### What should I do if the cooking zones are not functioning?

Check for the following possibilities:

- The fuse in the house wiring (fuse box) is intact. If the fuses trip a number of times, call an authorised electrician.
- The appliance is properly switched on.
- The control indicators in the control panel are illuminated.
- The cooking zone is switched on.
- The cooking zones are set at the desired heat settings.

### What should I do if the cooking zones will not switch on?

Check for the following possibilities:

- A period of more than 10 seconds has elapsed between when the On/Off button was actuated and the desired cooking zone switches on (see the section “Switching the appliance on”).
- The control panel is partially covered by a damp cloth or liquid.

### What should I do if the display except for the residual warmth indicator suddenly disappears?

This could be a result of one of two possibilities:

- The On/Off sensor was accidentally actuated.
- The control panel is partially covered by a damp cloth or liquid.

### What should I do if, after the cooking zones have been switched off, residual warmth is not indicated in the display?

Check for the following possibility:

- The cooking zone was only briefly used and therefore did not become hot enough. If the cooking zone is hot, please call the customer service centre.

### What should I do if the cooking zone will not switch on or off?

This could be due to one of the following possibilities:

- The control panel is partially covered by a damp cloth or liquid.
- The child safety lock is on.



### What should I do if the display is illuminated?

Check for the following:

- The control panel is partially covered by a damp cloth or liquid. To reset, press the “On/Off” control sensor.

### What does it mean when the burner does not glow red?

- The selected temperature of the cooking zone is maintained by a sensor that cycles the zone on and off, so the surface cooking area will not always glow red. If you select a low heat setting, the heat will cycle on and off more frequently than at higher settings. The heat also cycles on and off at the highest setting.

### What should I do if the display is illuminated?

Check for the following:

- The hob is overheated because of abnormal operation.
- After hob is cooled down, press the “On/Off” control sensor for resetting.

If you request a service call because of an error made in operating the appliance, the visit from the customer service technician may incur a charge even during the warranty period.

## SERVICE

Before calling for assistance or service, please check the section “Troubleshooting”. If you still need help, follow the instructions below.

### Is it a technical fault?

If so, please contact your customer service centre.

Always prepare in advance for the discussion. This will ease the process of diagnosing the problem and also make it easier to decide if a customer service visit is necessary.

Please take note of the following information.

- What form does the problem take?
- Under what circumstances does the problem occur?

When calling, please know the model and serial number of your appliance. This information is provided on the rating plate as follows:

- Model description
- S / N code (15 digits)

We recommend that you record the information here for easy reference.

Model: \_\_\_\_\_

Serial number: \_\_\_\_\_

### When do you incur costs even during the warranty period?

- if you could have remedied the problem yourself by applying one of the solutions provided in the section “Troubleshooting”.
- if the customer service technician has to make several service calls because he was not provided with all of the relevant information before his visit and as a result, for example, has to make additional trips for parts. Preparing for your phone call as described above will save you the cost of these trips.







# technical data

## TECHNICAL DATA

<b>Appliance dimensions</b>	Width	575 mm
	Depth	505 mm
	Height	52.6 mm
<b>Worktop cut - out dimensions</b>	Width	560 mm
	Depth	490 mm
	Corner radius	3 mm
<b>Connection voltage</b>		240 V ~ 50 Hz
<b>Maximum connected load power</b>		7.5 kW
<b>Weight</b>	Net	8.0 kg
	Gross	10.5 kg

TECHNICAL DATA & APPENDIX

## COOKING RINGS

Position	Diameter	Power
Front left	129 / 215 mm	810 / 2,360 W
Rear left	148 mm	1,300 W
Rear right	170 / 265 mm	1,590 - 1,700 / 2,540 W
Front right	148 mm	1,300 W

# appendix

## MODEL NAME & SERIAL NUMBER

Both the model name and the serial number are labeled underneath the cooktop base.

For later use, write down the information or attach the additional product label (located on the top of the product) onto the current page.

Model Name \_\_\_\_\_

Serial Number \_\_\_\_\_





note

---





note

---





# SAMSUNG

## QUESTIONS OR COMMENTS?

COUNTRY	CALL	OR VISIT US ONLINE AT
AUSTRALIA	1300 362 603	<a href="http://www.samsung.com/au/support">www.samsung.com/au/support</a>
NEW ZEALAND	0800 726 786	<a href="http://www.samsung.com/nz/support">www.samsung.com/nz/support</a>
CHINA	400-810-5858	<a href="http://www.samsung.com/cn/support">www.samsung.com/cn/support</a>
HONG KONG	3698 4698	<a href="http://www.samsung.com/hk/support">www.samsung.com/hk/support</a> (Chinese) <a href="http://www.samsung.com/hk_en/support">www.samsung.com/hk_en/support</a> (English)
INDIA	1800 40 SAMSUNG (1800 40 7267864) (Toll-Free)	<a href="http://www.samsung.com/in/support">www.samsung.com/in/support</a>
BANGLADESH	09612300300 08000300300 (Toll free)	<a href="http://www.samsung.com/in/support">www.samsung.com/in/support</a>
INDONESIA	021-5699-7777 0800-112-8888 (Toll Free)	<a href="http://www.samsung.com/id/support">www.samsung.com/id/support</a>
JAPAN	0120-363-905	<a href="http://www.galaxymobile.jp/jp/support">www.galaxymobile.jp/jp/support</a>
MALAYSIA	1800-88-9999 +603-7713 7420 (Overseas contact)	<a href="http://www.samsung.com/my/support">www.samsung.com/my/support</a>
PHILIPPINES	1-800-10-726-7864 [ PLDT Toll Free ] 1-800-8-726-78 [ Globe Landline and Mobile ] 02-422-2111 [ Standard Landline ]	<a href="http://www.samsung.com/ph/support">www.samsung.com/ph/support</a>
SINGAPORE	1800-SAMSUNG (726-7864)	<a href="http://www.samsung.com/sg/support">www.samsung.com/sg/support</a>
THAILAND	0-2689-3232 1800-29-3232 (Toll free)	<a href="http://www.samsung.com/th/support">www.samsung.com/th/support</a>
TAIWAN	0800-329-999 (All Product)	<a href="http://www.samsung.com/tw/support">www.samsung.com/tw/support</a>
VIETNAM	1800 588 889	<a href="http://www.samsung.com/vn/support">www.samsung.com/vn/support</a>
MYANMAR	+95-1-2399-88 VIP HHP +95-1-2399-990	<a href="http://www.samsung.com/th/support">www.samsung.com/th/support</a>
MACAU	0800 333	<a href="http://www.samsung.com/support">www.samsung.com/support</a>
SRI LANKA	+9411SAMSUNG (+94117267864) +94117540540 +9411590000	<a href="http://www.samsung.com/in/support">www.samsung.com/in/support</a>



DG68-00338A-04

