

*The*  
Plumbers



*The Plumbers* BIBLE



THE TRADESMAN'S CHOICE



THE TRADESMAN'S CHOICE

## IN THE BEGINNING THERE WAS MAN...



hen the **Wife** arrived and wanted a new place to live complete with all the mod cons including an ensuite, a powder room, toilet, bathroom with hot and cold running water, shower and spa, a kitchen with a plumbed in water filter, dishwasher, triple bowl sink and mixer tap, laundry with water saver washer, outside hot and cold tap to wash the dog, a swimming pool for when the kids arrive with an outdoor shower and some rainwater tanks and grey water recycling system and a reticulation watering system for the manicured gardens with a small water feature...



THE TRADESMAN'S CHOICE

**THEN CAME THE PLUMBER**



# CONTENTS

This Plumbing Bible has been developed to assist plumbers in selecting and using a range of Abey plumbing products. Abey is a wholly Australian owned family company. Most Abey plumbing products are proudly Australian made to conform to Australian and New Zealand Building Standards and conditions. Other products in the Abey range have been sourced and selected from all over the world as being "best of breed", providing plumbers the best world class solutions that help Save Time, Save Money or Save Space. Abey have been assisting plumbers for over 50 years by developing and manufacturing innovative and unique plumbing products, which is why Abey are 'The Tradesman's Choice'.

## SADDLE CLIPPING RANGE PAGES 9 - 16



Saddle Clips



Side Saddle Clips



1/2 Saddle Clips



Stand Off Clips



Storm Water Saddles

## INTERCHANGEABLE CLIPPING RANGE PAGES 17 - 31



Clip Heads



Encapsulated Nut Brackets



Extensions



Brackets

## INDUSTRIAL CLIPPING RANGE PAGES 33-53



Stand Off Brackets



Nut Clips



Brackets



Hanging Clips



All Thread Clips



Speed Clips

PLASTIC PLUMBING PAGES 55-65



Traps



Speed Traps



WC Connectors



Space Savers



Flexi Connectors



Plug & Waste Accessories



Extensions



Laundry Accessories

GENERAL PLUMBING PAGES 67-83



Water Hookers



Dishwasher Hookers



Gas Hookers



Isovalve



Cover Plates

ROOFING PAGES 85-97



Flue Kits



Airflex



Roofite



Downpipe Clips



Crimp Bends



Rainheads



Cowls



PossOff

## FIGHTING THE RUST DEMON

The scourge of the plumbing industry has to be the effects that corrosion has on plumbing products and materials. Pipe clips are prone to corrosion and unless correctly engineered and coated can break down and become a problem, especially in highly corrosive environment such as close to the sea. Welding is old and outdated technology. The weakest link can always be found in the weld. When it comes to clipping products, welding undermines the strength of the steel and is prone to corrosion. Abey's continual improvement program is developing products that fight the rust demon.



Abey understand this problem and are leading the way by phasing out welded products for good by developing and re-engineering their products.



Abey products are correctly coated and accurately machine pressed, offering 100% consistent quality, superior strength and are less prone to corrosion. AND importantly, they are a superior locally made products that cost around the same as inferior, cheap welded imports.



Abey have for over 50 years been the leading innovators in this field. Their products have helped lift standards and make plumbers' jobs a lot easier.

**STAMP  
OUT  
THE  
RUST DEMON**



# FIGHTING THE RUST DEMON



Welding undermines the strength of the steel and is prone to corrosion.



Machine pressed clipping products provide a greater strength than welding and are less prone to corrosion.



Materials and coatings on most imported clips are often dubious and may not conform to AS/NZ building standards.



Manufactured and supported locally, Abey products conform to AS/NZ building codes.



When your cheap Chinese clip breaks down, who do you complain to? Abey provides full nation wide support.



Hi tensile zinc coated nuts and bolts are often included. Quality of materials and coatings guaranteed.

[www.abeytrade.com.au](http://www.abeytrade.com.au)





ABEY CLIPS

SADDLE CLIPPING RANGE



Abey have for over 50 years been 'The Tradesman's Choice' for quality plumbing products. A proud 100% family owned company, employing over 150 people locally, Abey's streamlined manufacturing facilities produce a huge range of precision engineered products for the building and plumbing industry, that are cost competitive against overseas imports.

SADDLE CLIPS  
BSP

PAGE 11



SADDLE CLIPS  
PVC

PAGE 11



SADDLE CLIPS  
HDPE

PAGE 12

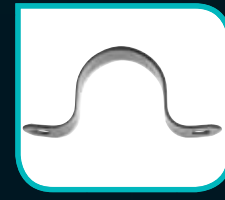

SIDE SADDLE CLIPS  
COPPER

PAGE 12



SADDLE CLIPS  
COPPER

PAGE 13-14

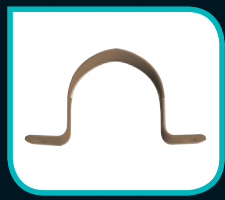

SADDLE CLIPS  
DWV

PAGE 15



STAND OFF SADDLE  
CLIPS

PAGE 15



STORMWATER SADDLE  
CLIPS

PAGE 16



THE TRADESMAN'S CHOICE

[www.abeytrade.com.au](http://www.abeytrade.com.au)

## DOMESTIC CLIPPING SYSTEM SADDLE CLIPS

For over five decades Abey have set the standards with their extensive range of high quality Australian Made G2-Z275 galvanised steel and powder coated Saddle Clips. Conforming to AS/NZ 3500 3.3.3, they offer the premium protection against electrolysis, corrosion and water hammer.



Quality Materials



Locally Made =  
Jobs for Aussies



National Distribution  
and Support



Australian Made Quality



Saddle Clip for BSP Pipe



Saddle Clip for Pressure



Saddle Clip for  
HDPE Pipe



½ Saddle Clip for  
Copper



Saddle Clip for Copper



Saddle Clip for Chrome  
& Copper



DWV Stand Off  
Saddle Clip



Storm Water Saddle Clip



## DOMESTIC CLIPPING SYSTEM SADDLE CLIPS FOR BSP PIPE

PRODUCT	DESCRIPTION	SIZE	CODE	
<b>Saddle Clips for Gal. (BSP) Pipe</b>	<b>Galvanised</b>			
	100 / box	1 x 20mm	15mm – ½" BSP	1400
	100 / box	1 x 22mm	20mm – ¾" BSP	1401
	100 / box	1 x 25mm	25mm – 1" BSP	1402
	100 / box	1.2 x 25mm	32mm – 1 ¼" BSP	1403
	50 / box	1.2 x 25mm	40mm – 1 ½" BSP	1404
	50 / box	1.2 x 25mm	50mm – 2" BSP	1405

## DOMESTIC CLIPPING SYSTEM PVC PIPE CLIPS (DWV)

PRODUCT	DESCRIPTION	SIZE	CODE	
<b>Saddle Clips for Pressure Pipe</b>	<b>Galvanised / Powder Coated – White</b>			
	100 / box	1 x 20mm	15mm – ½"	1421
	100 / box	1 x 22mm	20mm – ¾"	1422
	100 / box	1 x 25mm	25mm – 1"	1423
	100 / box	1.2 x 25mm	32mm – 1 ¼"	1424
	50 / box	1.2 x 25mm	40mm – 1 ½"	1424
	50 / box	1.2 x 25mm	50mm – 2"	1426

## DOMESTIC CLIPPING SYSTEM

# SADDLE CLIPS FOR HDPE & COPPER PIPE

PRODUCT	QTY	DESCRIPTION	SIZE	CODE
<b>Saddle Clips for Poly Pipe</b>				
Galvanised / Nylon coated – Black				
	100 / box	0.8 x 16mm	18mm – 5/8"	1431
	100 / box	0.8 x 16mm	20mm – 3/4"	1432
	100 / box	1 x 18mm	25mm – 1"	1433
<b>Half Saddle Clips for Copper Pipe</b>				
Galvanised / Nylon coated – Copper				
	200 / box	1 x 20mm	15mm – 1/2"	1476
	200 / box	1 x 22mm	20mm – 3/4"	1477
<b>Side Saddle Clips for Copper Pipe</b>				
Galvanised / Nylon coated – Copper				
	200 / box	0.8 x 13mm	12mm – 1/2"	1480
	200 / box	1.0 x 13mm	20mm – 3/4"	1481

Conforms to AS 3500.3.3.3

## ABEY'S SIDE SADDLE CLIP

Innovative pipe clip from Abey to improve your installations, in many situations.

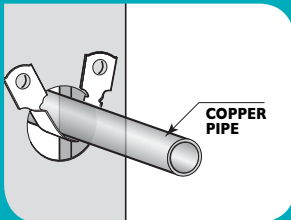

Side Saddle Clips in steel frame application

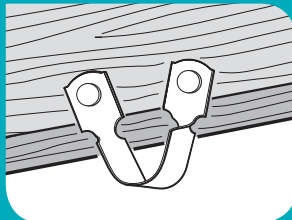

Typical floor bearer application

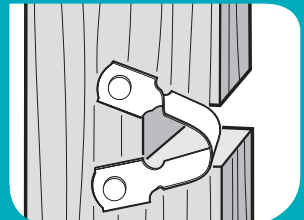

Typical stud wall application

# DOMESTIC CLIPPING SYSTEM

## SADDLE CLIPS FOR COPPER PIPE

PRODUCT	QTY	DESCRIPTION	SIZE	CODE
<b>Saddle Clips for Copper Pipe</b>				
<b>Galvanised / Nylon coated – Copper</b>				
	200 / box	0.6 x 13mm	12mm – 1/2"	1467
	200 / box	0.8 x 15mm	16mm – 5/8"	1468
	200 / box	0.8 x 15mm	20mm – 3/4"	1469
	200 / box	1 x 15mm	25mm – 1"	1470
	20 / box	1 x 16mm	32mm – 1 1/4"	1471
	20 / box	1 x 16mm	40mm – 1 1/2"	1472
	20 / box	1 x 18mm	50mm – 2"	1473

Conforms to AS 3500.3.3.3



[www.abeytrade.com.au](http://www.abeytrade.com.au)

## DOMESTIC CLIPPING PRODUCTS

### SADDLE CLIPS FOR COPPER PIPE

PRODUCT	QTY	DESCRIPTION	SIZE	CODE
Saddle Clips for Copper Pipe		Chrome Plated		

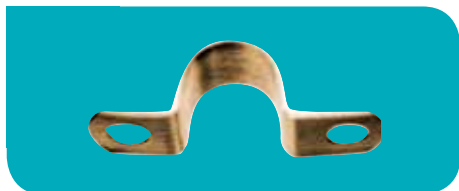

100 / box	0.6 x 13mm	12mm – ½"	1664
100 / box	0.8 x 15mm	20mm – ¾"	1666
100 / box	1 x 16mm	25mm – 1"	1667

Saddle Clips for Copper Pipe		Copper		
------------------------------	--	--------	--	--

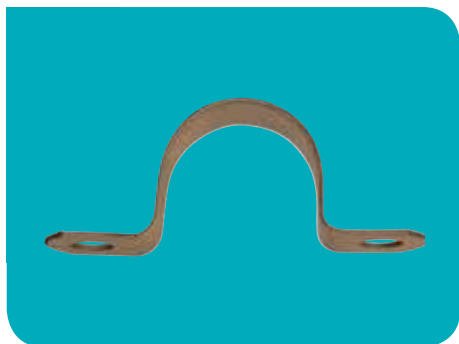

Conforms to AS 3500.3.3.3

100 / box	0.6 x 11mm	6mm – ¼"	1681
100 / box	0.6 x 11mm	8mm – 5/16"	1682
100 / box	0.6 x 11mm	10mm – 3/8"	1683
200 / box	0.6 x 13mm	12mm – ½"	1684
200 / box	0.8 x 15mm	16mm – 5/8"	1685
200 / box	0.8 x 15mm	20mm – ¾"	1686
200 / box	0.8 x 15mm	25mm – 1"	1687



## DOMESTIC CLIPPING PRODUCTS

### SADDLE CLIPS FOR DWV PIPE

PRODUCT	QTY	DESCRIPTION	SIZE	CODE
<b>Saddle Clips for DWV</b>	<b>Galvanised / Powder Coated – White</b>			
	100 / box	1.0 x 20mm	40mm – 1½"	1706
	100 / box	1.0 x 20mm	50mm – 2"	1707
	50 / box	1.0 x 20mm	65mm – 2½"	1708
	50 / box	1.0 x 20mm	80mm – 3"	1709
	50 / box	1.2 x 20mm	100mm – 4"	1710
	50 / box	1.2 x 20mm	150mm – 6"	1712

<b>Saddle Clips for DWV</b>	<b>Stainless Steel – Corrosive Environments</b>			
	50 / box	1.2 x 20mm	100mm – 4"	1710S

## STAND OFF SADDLE CLIPS FOR DWV PIPE

<b>Stand Off Saddle Clips for DWV</b>	<b>Stainless Steel – Corrosive Environments</b>			
	50 / box	1.5 x 20mm	100mm – 4"	1693S
	50 / box	1.2 x 20mm	90mm – 3½"	1696S

# DOMESTIC CLIPPING PRODUCTS

## STORMWATER SADDLE CLIPS

PRODUCT	QTY	DESCRIPTION	SIZE	CODE
<b>Stand Off Saddle Clips for DWV</b>	<b>Galvanised / Powder Coated – White</b>			
	100 / box	1.0 x 20mm	40mm – 1½"	1691
	100 / box	1.0 x 20mm	50mm – 2"	1692
	50 / box	1.0 x 20mm	65mm – 2½"	1694
	50 / box	1.0 x 20mm	80mm – 3"	1695
	50 / box	1.5 x 20mm	100mm – 4"	1693
	50 / box	1.5 x 20mm	90mm – 3½"	1696

## STORMWATER SADDLE CLIPS

<b>Stormwater Saddle Clips for DPC</b>	<b>Galvanised / Powder Coated – White</b>			
	20 / box	0.9 x 38mm	75mm	1909
	50 / box	0.9 x 20mm	90mm	1910/50

<b>Stormwater Saddle Clips</b>	<b>Stainless Steel – Corrosive Environments</b>			
	20 / box	0.9 x 20mm 20 per box	90mm	1910S

Conforms to AS 3500.3.3.3

Abey clipping and plumbing products are available at all good plumbing merchants.



# ABEY CLIPS INTERCHANGEABLE CLIPPING SYSTEM



As the leaders in innovation, Abey understand the plumbing industry and the needs of tradesmen. Over the years they have continuously developed products designed to be simple to use, highly effective and totally reliable.

**BOLTED CLIP HEADS  
PVC**

PAGE 19



**BOLTED CLIP HEADS  
COPPER**

PAGE 20



**BOLTED CLIP HEADS  
HDPE**

PAGE 21



**BOLTED CLIP HEADS  
PRESSURE**

PAGE 23



**BOLTED CLIP HEADS  
BSP**

PAGE 23



**CLIPS & BRACKETS  
STAINLESS STEEL**

PAGE 25



**BRACKETS, SHANKS &  
EXTENSIONS**

PAGES 27 - 31



THE TRADESMAN'S CHOICE

[www.abeytrade.com.au](http://www.abeytrade.com.au)



# INTERCHANGEABLE CLIPPING SYSTEM

Abey's 'interchangeable' bolted clipping system has endured the test of time. It has been engineered to the most stringent specifications and manufactured to suit all pipe sizes for domestic installations. Manufactured in Australia from G2-Z275 galvanised steel and further powder coated to colour match Copper, BSP, HDPE and DWV pipes as well as extra corrosion resistant stainless steel.

- ✓ The system provides a more streamlined and superior aesthetic finish
- ✓ Engineered to meet Australian and New Zealand building Codes
- ✓ Unique engineering feature creates a system of interchangeable Clips, Shanks and Brackets to minimise stock

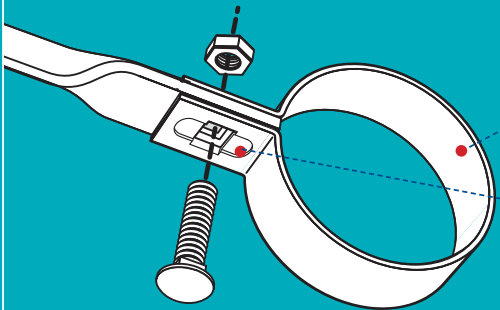

All Clip Heads engineered to meet exact specifications to allow for expansion and contraction



Notice the elongated recess and square hole. They are designed to ensure perfect alignment and eliminate movement

BOLTED CLIPS	SIZE	BUILT-IN STYLE BRACKETS	HANGING BRACKETS	ALL THREAD BRACKETS	ENCAPSULATED NUT BRACKET	STAND OFF BRACKETS	ADJUSTABLE STAND OFF	V LEGS
DWV PIPE CLIP HEADS	40-50	✓	✓	✓	✓	✓	✓	✓
DWV PIPE CLIP HEADS STAINLESS STEEL	40-100	✓	✓	✓	✓	✓	✓	✓
DWV EXPANSION CLIP HEADS	40-100	✓	✓	✓	✓	✓	✓	✓
COPPER CLIP HEADS	15-150	✓	✓	✓	✓	✓	✓	✓
HDPE PIPE CLIP HEADS	40-160	✓	✓	✓	✓	✓	✓	✓
PRESSURE PIPE CLIP HEADS	15-150	✓	✓	✓	✓	✓	✓	✓
PRESSURE STAINLESS STEEL CLIP HEADS	25-100	✓	✓	✓	✓	✓	✓	✓
GALVANISED PIPE CLIP HEADS	15-150	✓	✓	✓	✓	✓	✓	✓
STAINLESS STEEL CLIP HEADS	15-50	✓	✓	✓	✓	✓	✓	✓
GAS PIPE CLIP HEADS	75-300	✓	✓	✓	✓	✓	✓	✓

# INTERCHANGEABLE CLIPPING SYSTEM PVC PIPE CLIP HEADS (DWV)



PRODUCT	QTY	DESCRIPTION	SIZE	CODE
<b>PCV Pipe Clip Heads</b>	<b>Galvanised/Powder Coated – White</b>			



20 / box	1.5 x 20mm	40mm – 1½"	0001
20 / box	1.5 x 20mm	50mm – 2"	0002
20 / box	1.5 x 20mm	65mm – 2½"	0003
20 / box	1.5 x 20mm	80mm – 3"	0004
20 / box	1.5 x 20mm	90mm – 3½"	0049
20 / box	1.5 x 20mm	100mm – 4"	0005
20 / box	2.4 x 20mm	150mm – 6"	0006

<b>PCV Pipe Clip Heads</b>	<b>Stainless Steel</b>			
----------------------------	------------------------	--	--	--



20 / box	1.5 x 20mm	50mm – 2"	0002S
20 / box	1.5 x 20mm	90mm – 3½"	0010S
20 / box	1.5 x 20mm	100mm – 4"	0005S

<b>PVC Pipe Expansion Clip Heads</b>	<b>Galvanised/Powder Coated – White</b>			
--------------------------------------	---	--	--	--



Conforms to AS 3500 2.2 - 1996

20 / box	1.5 x 20mm	40mm – 1½"	0007
20 / box	1.5 x 20mm	50mm – 2"	0008
20 / box	1.5 x 20mm	65mm – 2½"	0009
20 / box	1.5 x 20mm	80mm – 3"	0010
20 / box	1.5 x 20mm	100mm – 4"	0011

## INTERCHANGEABLE CLIPPING SYSTEM COPPER PIPE CLIP HEADS (DWV)

PRODUCT	QTY	DESCRIPTION	SIZE	CODE
<b>Copper Pipe Clip Heads</b>	<b>Galvanised/Powder Coated – Copper</b>			
 <p>Conforms to AS 3500 2.2 - 1996</p>	20 / box	1.0 x 20mm	15mm – 5/8"	0026
	20 / box	1.0 x 20mm	20mm – 3/4"	0027
	20 / box	1.0 x 20mm	25mm – 1"	0028
	20 / box	1.0 x 20mm	32mm – 1 1/4"	0029
	20 / box	1.5 x 20mm	40mm – 1 1/2"	0030
	20 / box	1.5 x 20mm	50mm – 2"	0031
	20 / box	1.5 x 20mm	65mm – 2 1/2"	0032
	20 / box	1.5 x 20mm	80mm – 3"	0033
	20 / box	1.0 x 20mm	100mm – 4"	0034
	20 / box	2.4 x 20mm	150mm – 6"	0035



# INTERCHANGEABLE CLIPPING SYSTEM HDPE PIPE CLIP HEADS (DWV)

PRODUCT	QTY	DESCRIPTION	SIZE	CODE
HDPE Pipe Clip Heads (High Density Polyethylene coated black)		Galvanised/Powder Coated – Black		
 <p>Conforms to AS 3500 2.2 - 1996</p>	20 / box	1.0 x 20mm	40mm	0160
	20 / box	1.0 x 20mm	50mm	0161
	20 / box	1.5 x 20mm	56mm	0162
	20 / box	1.5 x 20mm	63mm	0163
	20 / box	1.5 x 20mm	75mm	0164
	20 / box	1.5 x 20mm	90mm	0165
	20 / box	1.5 x 20mm	110mm	0166
	20 / box	1.5 x 20mm	110mm	0167
	20 / box	2.0 x 20mm	125mm	0168

## INTERCHANGEABLE CLIPPING SYSTEM SPACING OF BRACKETS & CLIPS

The following spacing limitations for horizontal and vertical piping are derived from AS 3500. It is to be noted that with fire sprinkler installations an additional bracket is required to support a sprinkler branch within 300mm of the sprinkler.

Sprinkler piping shall be supported from structural members and clips designed to withstand the anticipated stresses and loads. Piping shall be secured to restrict movement during its normal life and upon sprinkler operation.



### Spacing of Brackets and Clips

NOMINAL COPPER/ STEEL PIPE SIZE	MAXIMUM SPACING OF BRACKETS & CLIPS (METRES)	NOMINAL PLASTIC PIPE SIZE	MAXIMUM SPACING OF BRACKETS & CLIPS (METRES)	
			HORIZONTAL	VERTICAL
DN20	1.5	DN20	.70	1.40
DN25	2.0	DN25	.75	1.50
DN32	2.5	DN32	.85	1.70
DN40	2.5	DN40	.90	1.80
DN50	3.0	DN50	1.05	2.10
DN65	3.0	DN65	1.20	2.40
DN80	4.0	DN80	1.30	2.60
DN90	4.0	DN90	1.40	2.80
DN100	4.0	DN100	1.50	3.00
DN125	4.0	DN125	1.70	3.40
DN150	4.0	DN150	2.00	4.00

**DISCLAIMER:**

The information in this publication has been assembled for guidance only. Care has been taken to ensure accuracy, but no liability can be accepted for any consequence which may arise as a result of its application.

**It may not be reproduced in whole or in part without the written consent of Abey Australia Pty Ltd.**

# INTERCHANGEABLE CLIPPING SYSTEM

## PRESSURE PIPE CLIP HEADS

PRODUCT	QTY	DESCRIPTION	SIZE	CODE
<b>Pressure Pipe Clip Heads</b>	<b>Galvanised/Powder Coated – White</b>			
	20 / box	1.2 x 20mm	15mm – 1/2"	0040
	20 / box	1.2 x 20mm	20mm – 3/4"	0041
	20 / box	1.2 x 20mm	25mm – 1"	0042
	20 / box	1.2 x 20mm	32mm – 1 1/4"	0043
	20 / box	1.5 x 20mm	40mm – 1 1/2"	0044
	20 / box	2.0 x 20mm	50mm – 2"	0045
	20 / box	2.0 x 20mm	65mm – 2 1/2"	0046
	20 / box	2.0 x 20mm	80mm – 3"	0047
	20 / box	2.0 x 20mm	100mm – 4"	0048
	20 / box	2.4 x 20mm	150mm – 6"	0072

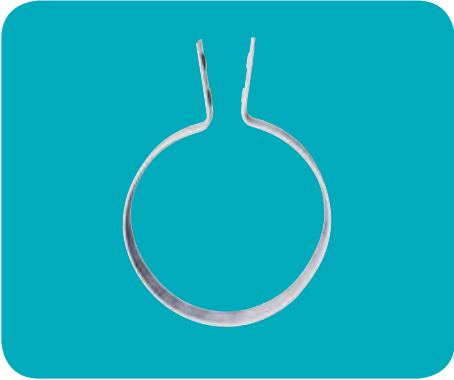
PRODUCT	QTY	DESCRIPTION	SIZE	CODE
<b>Galvanised Clip Heads for BSP Pipe</b>	<b>Galvanised</b>			
	20 / box	1.2 x 20mm	15mm – 1/2"	0012
	20 / box	1.2 x 20mm	20mm – 3/4"	0013
	20 / box	1.2 x 20mm	25mm – 1"	0014
	20 / box	1.2 x 20mm	32mm – 1 1/4"	0015
	20 / box	1.5 x 20mm	40mm – 1 1/2"	0016
	20 / box	2.0 x 20mm	50mm – 2"	0017
	20 / box	2.0 x 20mm	65mm – 2 1/2"	0018
	20 / box	2.0 x 20mm	80mm – 3"	0019
	20 / box	2.0 x 20mm	100mm – 4"	0020
	20 / box	2.4 x 20mm	150mm – 6"	0021

Conforms to AS 3500 2.2 - 1996

# abey

## TRADE

### AUSTRALIAN MADE

**EASY TO WORK WITH, INNOVATIVE, A RANGE OF QUALITY SHEETMETAL BUILDING & PLUMBING PRODUCTS THAT HAVE BEEN PROUDLY MANUFACTURED RIGHT HERE IN AUSTRALIA FOR OVER 50 YEARS.**



**GO AUSSIE – GO ABEY**



# INTERCHANGEABLE CLIPPING SYSTEM STAINLESS STEEL

Fight the rust demon with extra tough corrosion resistant stainless steel Clip Heads & Brackets.



## STAMP OUT THE RUST DEMON



PRODUCT	QTY	DESCRIPTION	SIZE	CODE
<b>PVC Pipe Clip Heads</b>		<b>Stainless Steel</b>		
 <p>Conforms to AS 3500.3.3.3</p>	20 / box	1.5 x 20mm	50mm – 2"	0002S
	20 / box	1.5 x 20mm	90mm – 3 1/2"	0010S
	20 / box	1.5 x 20mm	100mm – 4"	0005S
<b>Adjustable Stand Off Bracket</b>		<b>Stainless Steel</b>		
	20 / box	Stainless Steel Adjustable Stand Off Bracket 1.5 x 20mm		0080S
<b>Stand off Bracket</b>		<b>Stainless Steel</b>		
	20 / box	Stand Off Bracket Stainless Steel – 2.0 x 20mm		0060S



# INTERCHANGEABLE CLIPPING SYSTEM BRACKETS, SHANKS & EXTENSIONS



Abey's miraculous range of interchangeable Brackets, Shanks & Extensions are a god send enabling plumbers to mix and match to create mounting and support solutions for almost any situation and application.



Light Hanging Brackets & extension



V Legs



Adjustable Stand Off Brackets



Stand Off Brackets



Encapsulated Nut Bracket







All Thread Bracket 10mm



# INTERCHANGEABLE CLIPPING SYSTEM BRACKETS, SHANKS & EXTENSIONS

PRODUCT	QTY	DESCRIPTION	SIZE	CODE
<b>Extension Arm</b>		<b>Galvanised</b>		
	50 / box	1.5 x 20mm	300mm	0058
<b>Light Hanging Bracket</b>		<b>Galvanised</b>		
	50 / box	1.5 x 20mm	300mm	0059
	10 / box	1.5 x 20mm	600mm	0082
<b>Bolted Clip Shank</b>		<b>Galvanised</b>		
	25 / box	3.0 x 20mm	225mm	0052
	25 / box	3.0 x 20mm	300mm	0053
	25 / box	3.0 x 20mm	450mm	0054
	25 / box	3.0 x 20mm	600mm	0055
<b>V Legs</b>		<b>Galvanised</b>		
	20 pr / box	Galvanised – 1.5 x 20mm		0067

# INTERCHANGEABLE CLIPPING SYSTEM BRACKETS, SHANKS & EXTENSIONS

PRODUCT	QTY	DESCRIPTION	SIZE	CODE
<b>V legs</b>				
<b>Galvanised / Powder Coated – White</b>				
	20 pr / box	Galvanised/Powder Coated –1.5 x 20mm		0067
<b>Nuts &amp; Bolts – for Shanks</b>				
	100 / box	Hi-tensile zinc	7 x 25mm	0068
<b>Nuts &amp; Bolts – for Extension Arms</b>				
	100 / box	Hi-tensile zinc	6 x 13mm	0069
<b>Welded Nut Bracket</b>				
	50 / box	Galvanised – 4.0 x 20mm	10mm	0063
<b>Encapsulated Nut Bracket</b>				
	50 / box	Galvanised – 4.0 x 20mm	10mm	0062

# INTERCHANGEABLE CLIPPING SYSTEM ENCAPSULATED NUT BRACKET



Abey's Encapsulated Nut Bracket has been designed for use with the Abey Interchangeable Clipping System for pipework from 10-250mm. For use in hanging situations, Abey have developed this product to replace the old style welded nut bracket as welding has traditionally been the weak point. This unique product reduces any potential for corrosion and weld failure. Easy to hang 10mm pipe for all thread applications. Hallelujah!



Unique construction eliminates welds which is where corrosion usually occurs.



Galvanised steel enclosure around hi-tensile zinc plated nut. Strength tested to 1500kg.

See instructional web video – [www.abeytrade.com.au](http://www.abeytrade.com.au)



Trim thread to length.



Secure all thread to masonry anchor point.



Screw Abey's encapsulated nut bracket onto all thread.



Fit pipe and secure lower section with bolts and nuts supplied.



# INTERCHANGEABLE CLIPPING SYSTEM BRACKETS & ACCESSORIES

PRODUCT

QTY

DESCRIPTION

SIZE

CODE

## Tube Spanner



25 / box

Galvanised

0084

## All Thread Bracket



50 / box

Galvanised –  
4.0 x 23mm

10mm

0061M



50 / box

All Thread Bracket –  
Coated  
Galvanised/ Powder  
Coated white –  
4.0x23mm

10mm

0077M

## Stand Off Bracket – Coated

Galvanised / Powder Coated / **Stainless Steel**



20 / box

Stand Off Bracket.  
Stainless Steel –  
2.0 x 20mm

0060S



50 / box

Stand Off Bracket –  
coated. Galvanised /  
Powder Coated white  
– 2.0 x 20mm

0078



50/box

Stand Off Bracket –  
Galvanised  
2.0 x 20mm

0060

## Adjustable Stand Off Bracket – Coated

Galvanised / Powder Coated / **Stainless Steel**



25 / box

Adjustable Stand Off  
Bracket/Galvanised –  
2.0 x 22mm

0080



25 / box

Adjustable Stand Off  
Bracket White –  
2.0 x 20mm

0079



20 / box

Stainless Steel  
Adjustable Stand Off  
Bracket, 1.5 x 20mm

0080S

## ADJUSTABLE STAND OFF BRACKETS

Abey's Adjustable Stand Off Bracket is a very versatile tool that should be part of every plumber's kit. It comes in 2 parts and with a pair of pliers can easily be snapped off to any required length from 30-60mm. Then fit them off as you would a normal Stand Off Bracket. They can be used in uneven wall situations to provide a straight fitting point. They can also be used in underfloor situations to fit off pipes. Simply snap off to create the proper fall allowance.

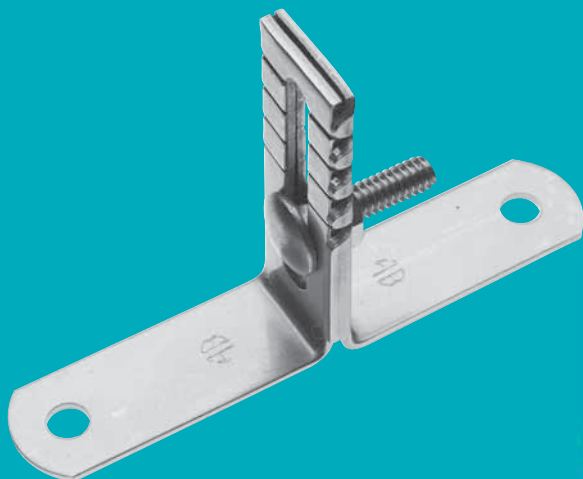

AVAILABLE IN –

- POWDER COATED – WHITE
- GALVANISED
- STAINLESS STEEL

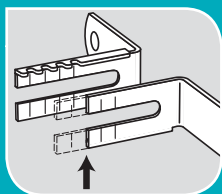

Abey's Adjustable Stand Off Bracket comes in two pieces. Simply measure the distance for the pipe to stand off the wall, and snap bracket to appropriate size.



See instructional web video – [www.abeytrade.com.au](http://www.abeytrade.com.au)

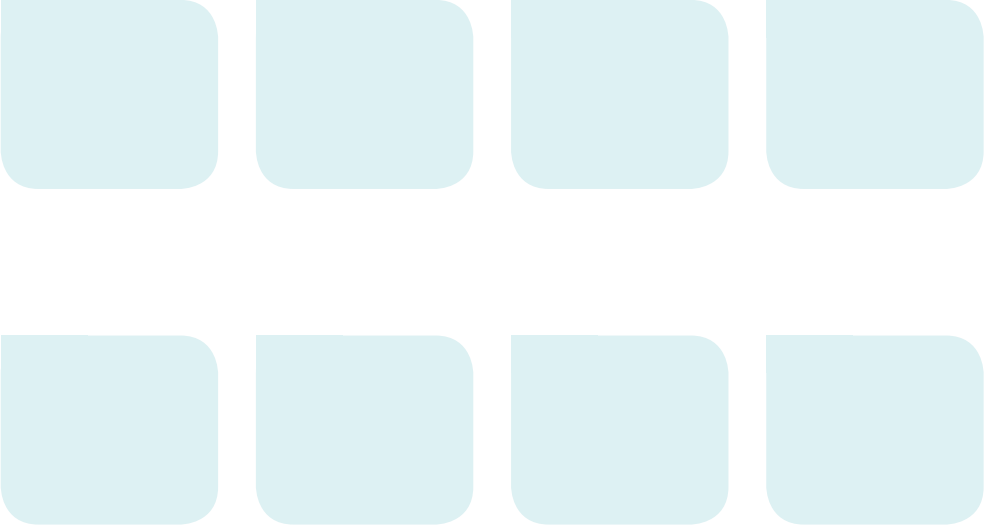



## ABEY CLIPS

## INDUSTRIAL BOLTED CLIPPING



Abey provide national distribution and support for all their products. So when help or advice is required, Abey are always on hand and stand behind their products. For more information about Abey's Industrial Clipping range, see instructional web video – [www.abeytrade.com.au](http://www.abeytrade.com.au)

## STAND OFF CLIPS

PAGES 34 - 35



## NUT CLIPS

PAGES 36 - 40



## NUT CLIP &amp; STANDOFF BRACKETS

PAGES 41 - 43



## FIRE SERVICE

PAGE 44



## DOUBLE BOLTED CLIPS

PAGE 45



## HANGING CLIPS

PAGES 46 - 47



## ALL THREAD CLIPS

PAGES 48 - 49



## SPEED CLIPS

PAGES 50 - 53



THE TRADESMAN'S CHOICE

[www.abeytrade.com.au](http://www.abeytrade.com.au)

## INDUSTRIAL BOLTED CLIPPING STAND OFF CLIPS

Abey Industrial Stand Off Clips for PVC pipe, are a 2 piece clip manufactured without welds to eliminate the evils of corrosion for 40-150mm pipe sizes. They are easy to position and fit, even with existing pipework to provide a neater looking finished result.

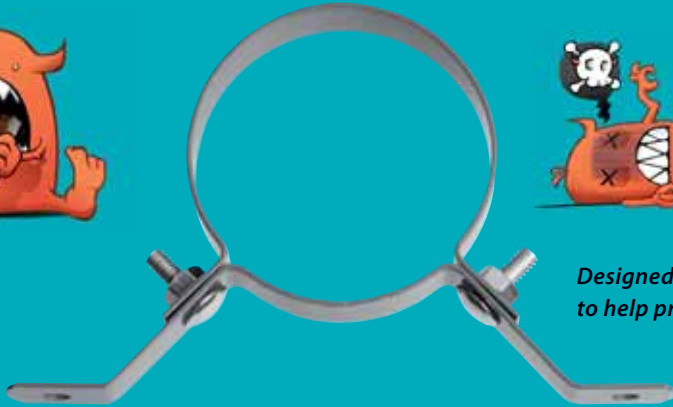

*Designed without welds  
to help prevent rust*



1. Two part clip for new and retro fit applications



2. Position bracket and fasten to wall



3. Place pipe into bracket base



4. Secure front of the brace with bolt & nuts (supplied)



5. Fasteners neatly hidden behind pipe



View Instructional web Video – [www.abeytrade.com.au](http://www.abeytrade.com.au)

## INDUSTRIAL BOLTED CLIPPING STAND OFF CLIPS

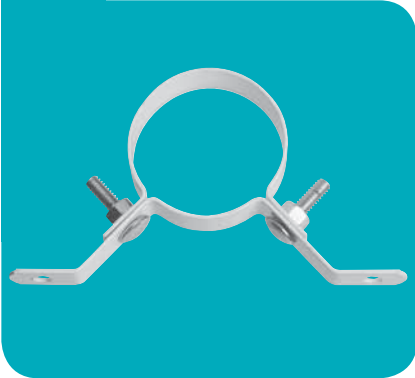
PRODUCT	QTY	DESCRIPTION	SIZE	CODE
Stand Off Clips for PVC Pipe	Galvanised/Powder Coated – White			
	25 / box	1.5 x 20mm	40mm	0120
	25 / box	1.5 x 20mm	50mm	0121
	25 / box	1.5 x 20mm	65mm	0122
	25 / box	1.5 x 20mm	80mm	0123
	25 / box	1.5 x 20mm	90mm	0126
	25 / box	2.0 x 20mm	100mm	0124
	25 / box	2.0 x 25mm	150mm	0125

Conforms to AS 2887:1993 



*Australian Made . . . Superior Coatings*

[www.abeytrade.com.au](http://www.abeytrade.com.au)

## INDUSTRIAL BOLTED CLIPPING NUT CLIPS

The biggest difference plumbers may notice between the Abey product and imported clips is the welding. While both look similar, Abey's newest nut clips are no longer welded but machine pressed, which means they are stronger, more consistent better quality products, that fight the rust demons.

Imported products are often welded by hand making their quality inconsistent.

**Abey's Industrial Nut clips – are machine pressed and are available for:**

- ✓ DWV
- ✓ Gal and
- ✓ Copper
- ✓ HDPE pipe



For sizes ranging from 12 – 300mm diameter.

A powder coating is applied to the galvanised clip to give extra corrosion protection.



Abey's manufacturing facility showing the powder coating operation

View video of Abey's range of Industrial Plumbing products on – [www.abeytrade.com.au](http://www.abeytrade.com.au)



# INDUSTRIAL BOLTED CLIPPING NUT CLIPS FOR DWV PIPE

PRODUCT	QTY	DESCRIPTION	SIZE	CODE
<b>Nut Clips for DWV Pipe</b>				
<b>Galvanised/Powder Coated – White</b>				

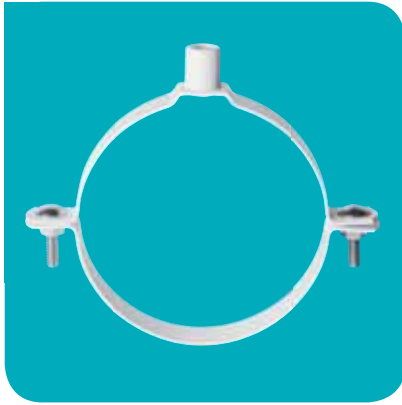



Conforms to AS 2887:1993 

25 / box	M10 – 2.0 x 20mm	40mm	5170
25 / box	M10 – 2.0 x 20mm	50mm	5171
25 / box	M10 – 2.0 x 20mm	60mm	5172
25 / box	M10 – 2.0 x 20mm	80mm	5173
25 / box	M10 – 2.0 x 20mm	90mm	5176
25 / box	M10 – 2.4 x 20mm	100mm	5174
25 / box	M10 – 2.4 x 20mm	100mm	5245
10 / box	M10 – 3.0 x 25mm	150mm	5175
10 / box	M12 – 3.0 x 25mm	150mm	5246
25 / box	M10 – 3.0 x 25mm	225mm	5280
25 / box	M12 – 3.0 x 25mm	225mm	5161
1 / pck	M10 – 3.0 x 25mm	300mm	5281
1 / pck	M12 – 3.0 x 25mm	300mm	5162



[www.abeytrade.com.au](http://www.abeytrade.com.au)

# INDUSTRIAL BOLTED CLIPPING NUT CLIPS FOR COPPER PIPE

PRODUCT	QTY	DESCRIPTION	SIZE	CODE
<b>Nut Clips for Copper Pipe</b>		<b>Galvanised/Powder Coated – Copper</b>		
 <p>Conforms to AS 2887:1993 </p>	25 / box	M10 – 1.5 x 20mm	12mm – ½"	5165
	25 / box	M10 – 1.5 x 20mm	16mm – ⅝"	5166
	25 / box	M10 – 1.5 x 20mm	20mm – ¾"	5177
	25 / box	M10 – 1.5 x 20mm	25mm – 1"	5178
	25 / box	M10 – 1.5 x 20mm	32mm – 1 ¼"	5179
	25 / box	M10 – 2.0 x 20mm	40mm – 1 ½"	5180
	25 / box	M10 – 2.0 x 20mm	50mm – 2"	5181
	25 / box	M10 – 2.0 x 20mm	65mm – 2 ½"	5182
	25 / box	M10 – 2.0 x 20mm	75mm – 3"	5183
	25 / box	M10 – 3.0 x 25mm	100mm – 4"	5184
	Made to order	M12 – 3.0 x 25mm	100mm – 4"	5159
	25 / box	M10 – 3.0 x 25mm	125mm – 5"	5130
	25 / box	M12 – 3.0 x 25mm	125mm – 5"	5186
	Made to order	M12 – 3.0 x 25mm	150mm – 6"	5185*
	Made to order	M10 – 3.0 x 25mm	200mm – 8"	5163*
	Made to order	M12 – 3.0 x 25mm	200mm – 8"	5164*



# INDUSTRIAL BOLTED CLIPPING

## NUT CLIPS FOR BSP & HDPE PIPE



PRODUCT	QTY	DESCRIPTION	SIZE	CODE
<b>Nut Clips – For BSP Pipe – Machine Pressed Galvanised</b>				



Conforms to AS 2887:1993 

25 / box	M10 – 2mm x 20mm	25mm	5189
25 / box	M10 – 2mm x 20mm	32mm	5190
25 / box	M10 – 2mm x 20mm	40mm	5191
25 / box	M10 – 2mm x 20mm	50mm	5192
25 / box	M10 – 2mm x 20mm	65mm	5193
25 / box	M10 – 2mm x 20mm	80mm	5194
25 / box	M10 – 2mm x 20mm	100mm	5195
25 / box	M10 – 3mm x 25mm	32mm	5111
25 / box	M10 – 3mm x 25mm	40mm	5112
25 / box	M10 – 3mm x 25mm	50mm	5113
25 / box	M12 – 3mm x 25mm	65mm	5114
25 / box	M12 – 3mm x 25mm	80mm	5115
25 / box	M12 – 3mm x 25mm	100mm	5116
10 / box	M12 – 3mm x 25mm	125mm	5196
10 / box	M12 – 4mm x 30mm	150mm	5117

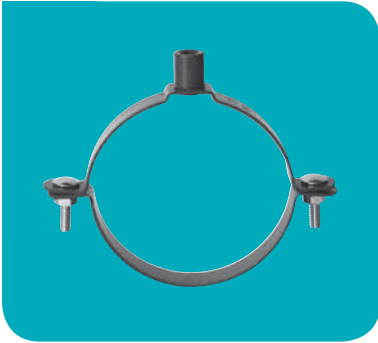
## INDUSTRIAL BOLTED CLIPPING NUT CLIP BRACKETS

PRODUCT	QTY	DESCRIPTION	SIZE	CODE
<b>Nut Clips for HDPE Pipe ( High Density) Galvanised/Powder Coated – Black</b>				
 <p>Conforms to AS 2887:1993 </p>	25 / box	M10 – 2.0 x 20mm	40mm	5140
	25 / box	M10 – 2.0 x 20mm	50mm	1541
	25 / box	M10 – 2.0 x 20mm	56mm	5142
	25 / box	M10 – 2.0 x 20mm	63mm	5143
	25 / box	M10 – 2.0 x 20mm	75mm	5144
	25 / box	M10 – 2.0 x 20mm	90mm	5145
	25 / pck	M10 – 2.4 x 20mm	110mm	5146
	1 / pck	M12 – 2.4 x 20mm	110mm	5150
	25 / box	M10 – 2.4 x 20mm	114mm	5147
	10 / box	M10 – 2.4 x 20mm	125mm	5148
	10 / box	M12 – 2.4 x 20mm	125mm	5131
	10 / box	M12 – 3.0 x 25mm	160mm	5149
	1 / pck	M12 – 3.0 x 25mm	200mm	5152
	1 / pck	M12 – 3.0 x 25mm	250mm	5151
	1 / pck	M12 – 3.0 x 25mm	300mm	5153





# INDUSTRIAL BOLTED CLIPPING NUT CLIP BRACKETS

PRODUCT	QTY	DESCRIPTION	SIZE	CODE
<b>Purlin Bracket</b>	<b>Zinc Plated</b>			



50 / box	Zinc Plated – M10	3.0 x 25mm	5210
----------	-------------------	------------	------

<b>Vertical Mounting Bracket (Fire Service)</b>	<b>Zinc Plated</b>			
---	--------------------	--	--	--

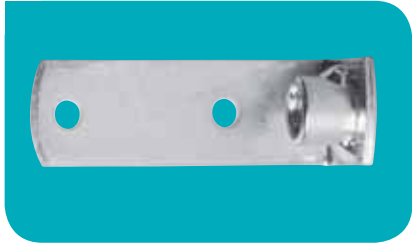

50 / box	M10	3.0 x 25mm	5212
1 / pck	M12	3.0 x 25mm	5213

<b>Horizontal Mounting Bracket (Fire Service)</b>	<b>Zinc Plated</b>			
---	--------------------	--	--	--

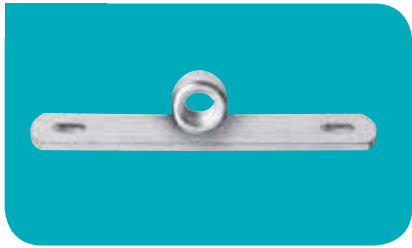

50 / box	M10	3.0 x 25mm	5214
50 / box	M12	3.0 x 25mm	5215

Conforms to AS 2887:1993 



## INDUSTRIAL BOLTED CLIPPING STAND OFF BRACKETS

In line with Abey's continuous product improvement program they are currently phasing out and re-engineering their welded products due to the inherent weakness and corrosion issues associated with welding. Their new Stand Off Bracket is pressed, has no welds, is stronger and offers greater rust resistance and longevity than welded brackets, especially useful in moist and highly corrosive environments. Insist on Abey and avoid the risks of inferior imports.



All Abey Nut Clip Stand Off brackets are pressed, 'Not Welded', providing superior strength and rust resistance.



# INDUSTRIAL BOLTED CLIPPING STAND OFF BRACKETS

PRODUCT	QTY	DESCRIPTION	SIZE	CODE
Nut Clip Stand Off Bracket (Pressed)		Galvanised		

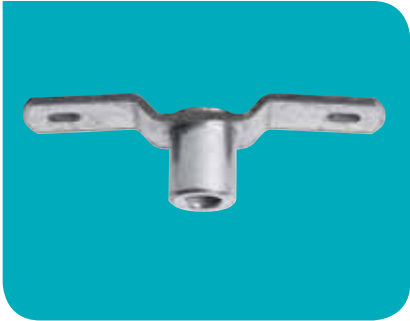

25 / box	M10	2.0 x 25mm	5160
----------	-----	------------	------

25 / box	M12	3.0 x 25mm	5168
----------	-----	------------	------

Fire Service Stand Off Bracket (Pressed)		Zinc Plated		
--	--	-------------	--	--

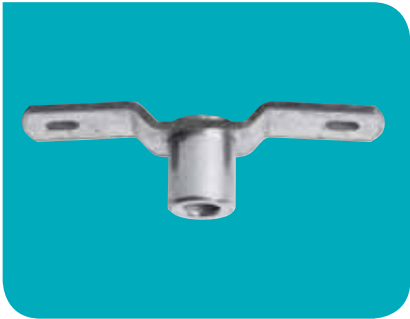

50 / box	M10	3.0 x 25mm	5216
----------	-----	------------	------

50 / box	M12	3.0 x 25mm	5217
----------	-----	------------	------



## INDUSTRIAL BOLTED CLIPPING FIRE SERVICE

PRODUCT	QTY	DESCRIPTION	SIZE	CODE
<b>Welded Nut Clips for Galvanised Pipe</b>	<b>Zinc Plated</b>			
	25 / pck	M10 – 3.0 x 25mm	25mm	5202
	25 / pck	M10 – 3.0 x 25mm	32mm	5203
	25 / pck	M10 – 3.0 x 25mm	40mm	5204
	25 / pck	M10 – 3.0 x 25mm	50mm	5205
	25 / pck	M12 – 3.0 x 25mm	65mm	5206
	25 / pck	M 12 – 3.0 x 25mm	80mm	5207
	25 / pck	M12 – 4.0 x 30mm	100mm	5208
	25 / pck	M12 – 4.0 x 30mm	150mm	5209
	25 / pck	M12 – 4.0 x 30mm	200mm	5228

Items with asterisk against their code number are 'made to order'. Lead time is normally 10-15 working days. Minimal orders apply.

PRODUCT	QTY	DESCRIPTION	SIZE	CODE
<b>Welded Nut Clips for Copper Pipe</b>	<b>Galvanised/Powder Coated – Copper</b>			
	10 / pck	M12 – 4.0 x 30mm	100mm – 4"	5233
	10 / pck	M12 – 4.0 x 30mm	125mm – 5"	5230
	10 / pck	M12 – 4.0 x 30mm	150mm – 6"	5231
	10 / pck	M12 – 4.0 x 30mm	200mm – 8"	5232

Conforms to AS 2887:1993 



# INDUSTRIAL BOLTED CLIPPING

## DOUBLE BOLTED CLIPS

PRODUCT	QTY	DESCRIPTION	SIZE	CODE
<b>Double Bolted Clips for Copper Pipe</b>				
<b>Galvanised/Powder Coated – Copper Colour</b>				



1 / pck	M12 x 2 – 4.0 x 30mm	100mm	5270
1 / pck	M12 x 2 – 4.0 x 30mm	125mm	5271
1 / pck	M12 x 2 – 4.0 x 30mm	150mm	5272
1 / pck	M12 x 2 – 4.0 x 30mm	200mm	5273

<b>Double Bolted Clips for BSP Pipe</b>				
<b>Zinc Plated</b>				



1 / pck	M12 x 2 – 4.0 x 30mm	100mm	5260
1 / pck	M12 x 2 – 4.0 x 30mm	150mm	5261
1 / pck	M12 x 2 – 4.0 x 30mm	200mm	5262



## INDUSTRIAL BOLTED CLIPPING HANGING CLIPS – FOR PVC PIPE

Faster, non welded for strength and greater corrosion resistance, made from high quality G2-227s galvanised steel to conform to AS/NZ building codes.

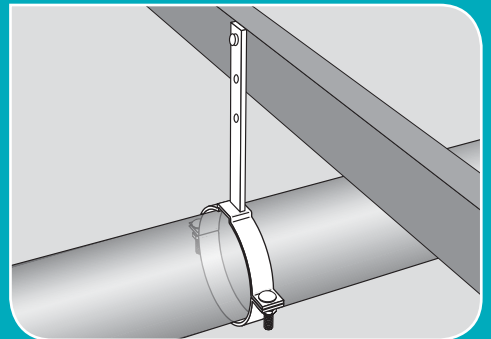
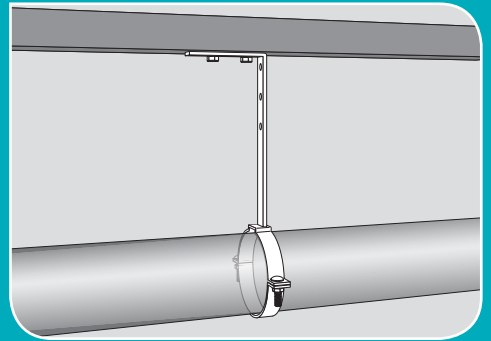
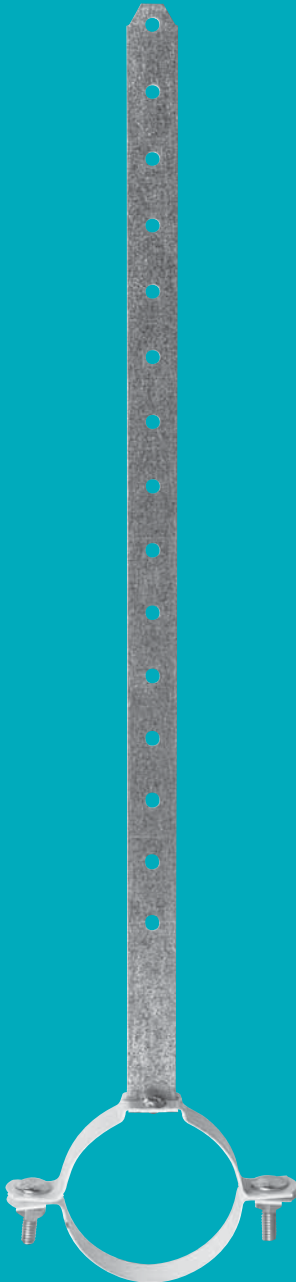

Hanging clips can be bent and fixed to masonry at two points or fixed directly to the bearer.



# INDUSTRIAL BOLTED CLIPPING HANGING CLIPS - FOR PVC PIPE

PRODUCT	QTY	DESCRIPTION	SIZE	CODE
<b>Adjustable Hanging Clip for PVC (DWV) Galvanised/Powder Coated - White</b>				



20 / box	250mm shank	40mm	5250
20 / box	250mm shank	50mm	5251
20 / box	250mm shank	65mm	5252
20 / box	250mm shank	80mm	5253
20 / box	250mm shank	90mm	5254
20 / box	250mm shank	100mm	5255

<b>Hanging Clips for PVC Pipe 450mm Shank Galvanised/Powder Coated - White</b>				
--	--	--	--	--

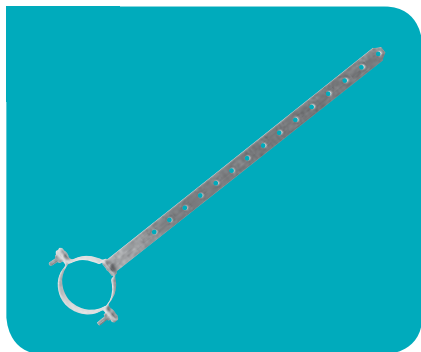

20 / box	450mm shank	40mm	0150
20 / box	450mm shank	50mm	0151
20 / box	450mm shank	65mm	0152
20 / box	450mm shank	80mm	0153
20 / box	450mm shank	90mm	0156
20 / box	450mm shank	100mm	0154



## INDUSTRIAL BOLTED CLIPPING ALL THREAD CLIPS



Abey industrial All Thread Clips are rated for industrial applications of up to 1500kg for PVC, & Gal pipe. There are no welds and they are galvanised and powder coated to eliminate corrosion potential and conform to AS/NZ building codes. They also offer a unique feature for adjustment of pipe fall.



1. Trim All Thread to required length. Measure and mark off fall line and screw the first locating nut above this position



2. Position bracket and swing lower section out of the way and fit pipe.



3. Secure the lower section with the hi-tensile, zinc plated bolts and nuts. (supplied)



4. Fit remaining pipe and make any minor pipe fall adjustments prior to tightening off.



View Instructional web Video – [www.abeytrade.com.au](http://www.abeytrade.com.au)



# INDUSTRIAL BOLTED CLIPPING ALL THREAD CLIPS

PRODUCT	QTY	DESCRIPTION	SIZE	CODE
All Thread Clips for PVC Pipe	Galvanised/Powder Coated – White			
	25 / box	2.0 x 20mm	40mm	0170
	25 / box	2.0 x 20mm	50mm	0171
	25 / box	2.0 x 20mm	65mm	0172
	25 / box	2.0 x 20mm	80mm	0173
	25 / box	2.0 x 20mm	100mm	0174
	10 / box	3.0 x 25mm	150mm	0175

Conforms to AS 2887:1993 



[www.abeytrade.com.au](http://www.abeytrade.com.au)

## INDUSTRIAL BOLTED CLIPPING ABEY SPEED CLIPS

Abey's miraculous SPEED Clips are a godsend. Invented, developed and manufactured locally, Abey SPEED Clips are the latest and greatest clipping product on the market today. These unique clips can reduce installation time by up to 50% and eliminate the fiddly, awkward and sometimes dangerous process of hanging heavy pipework while trying to fit fiddly nuts and bolts.

Abey SPEED Clips enable plumbers to hang pipework and make adjustments prior to tightening, reducing many installations to just a one man job.

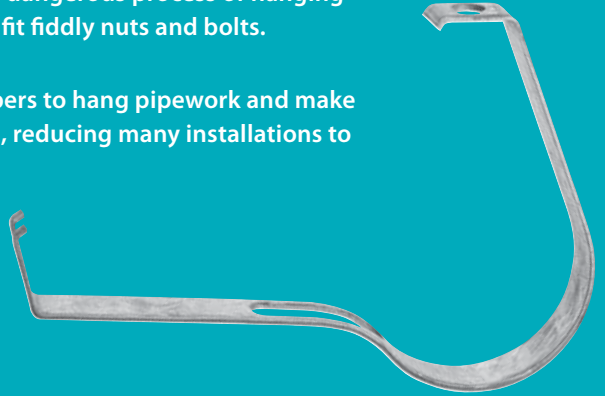

Abey SPEED Clips come in 3 styles to suit most common pipes sizes:



1. Speediest snap lock style SPEED Clip for pipes 20-65mm diameter, provides plumbers the fastest installation clipping system ever.



2. Heavy duty SPEED Clip for heavy bsp pipes 80 to 150mm in diameter.



3. And a larger snap lock clip for DWV pipes 100 to 250mm in diameter.

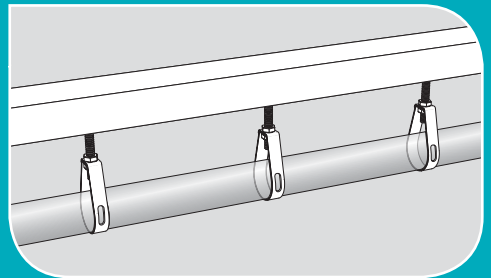
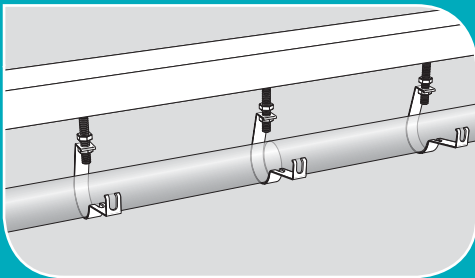

# INDUSTRIAL BOLTED CLIPPING ABEY SPEED CLIPS



1. Measure off and fit bulldog fastenings.



2. Trim All Thread and secure to masonry anchor point.



3. Measure fall and spin on top nut approx 5mm above the measure.



4. Finish off row and simply hang pipe on bracket, SPEED Clip will hold pipe temporarily allowing final adjustment.



5. Then simply fold SPEED Clip arm upwards and 'snap' into place to lock shut.



6. Tighten top nut to secure.



“ SPEED Clips can actually support the pipe to allow adjustments to be made prior to tightening. Once pipework is correctly positioned you simply 'SNAP' lock the SPEED Clip and tighten the top nut, providing the fastest and easiest installation ever. ”



See instructional web video – [www.abeytrade.com.au](http://www.abeytrade.com.au)

[www.abeytrade.com.au](http://www.abeytrade.com.au)

## INDUSTRIAL BOLTED CLIPPING

### ABEY SPEED CLIPS

PRODUCT	QTY	DESCRIPTION	SIZE	CODE
<b>SPEED Clips for BSP Pipe</b>		<b>Galvanised</b>		
	75 / box	1.5 x 20mm, Galvanised	20mm	P20
	60 / box	1.5 x 20mm, Galvanised	25mm	P25
	50 / box	2.0 x 20mm, Galvanised	32mm	P32
	40 / box	2.0 x 20mm, Galvanised	40mm	P40
	30 / box	2.0 x 20mm, Galvanised	50mm	P50
	30 / box	2.0 x 20mm, Galvanised	65mm	P65

PRODUCT	QTY	DESCRIPTION	SIZE	CODE
<b>SPEED Clips for BSP Pipe</b>		<b>Galvanised</b>		
	20 / box	3.0 x 25mm, Galvanised	80mm	PH80
	10 / box	4.0 x 30mm, Galvanised	100mm	PH100
	10 / box	5.0 x 32mm, Galvanised	150mm	PH150

Conforms to AS 2887:1993 

# INDUSTRIAL BOLTED CLIPPING

## ABEY SPEED CLIPS



PRODUCT	QTY	DESCRIPTION	SIZE	CODE
SPEED Clips for DWV Pipe		Powder Coated – White		
	40 / box	2.0 x 20mm, Coated – White	40mm	P40C
	30 / box	2.0 x 20mm, Coated – White	50mm	P50C
	30 / box	2.0 x 20mm, Coated – White	50mm	P65C
	20 / box	2.0 x 20mm, Coated – White	90mm	PH90C
	20 / box	2.0 x 20mm	100mm	P100C
	10 / pck	2.0 x 25mm	150mm	P150C
	10 / pck	2.0 x 25mm	250mm	P250C



[www.abeytrade.com.au](http://www.abeytrade.com.au)

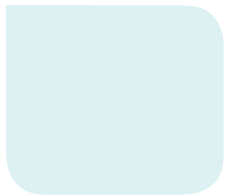
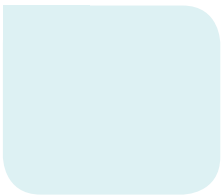
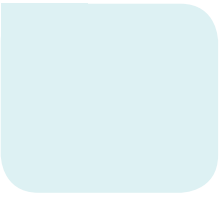

# ABEY FANTASTIC PLASTIC PRODUCTS



Abey's 'fantastic plastic' range of plumbing products provide simple solutions to save you time, money and space. These 'best of breed' products have been selected from the world's best manufacturers to provide you quality plumbing solutions at the right price.

## AIR ADMITTANCE VALVES

PAGES 56 - 57



## BOTTLE TRAPS

PAGES 58 - 59



## WC CONNECTORS

PAGES 60 - 61



## SPACE SAVERS

PAGES 62 - 63



## LAUNDRY ACCESSORIES

PAGE 63



## FLEXIBLE WASTE CONNECTORS

PAGES 64 - 65



THE TRADESMAN'S CHOICE

[www.abeytrade.com.au](http://www.abeytrade.com.au)

# ABEY'S FANTASTIC PLASTIC AIR ADMITTANCE VALVES (VENTAPIPE)

Abey's Ventapipe Air Admittance Valves are for use in above ground drainage systems to enable ventilating pipes to be terminated within the building. Easier, faster installations are gained, negating the need for roof penetrations.

- ✓ Prevents the release of foul air
- ✓ Reduces risk of syphoning
- ✓ Can be used in most internal situations
- ✓ Used in both new and existing systems
- ✓ Allows for greater design flexibility
- ✓ Reduces material and labour costs
- ✓ Rigorously tested
- ✓ Will not unseal



## As a Trap Vent

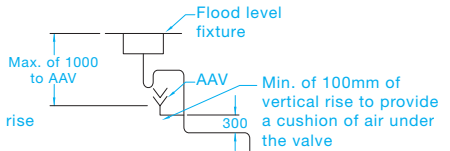
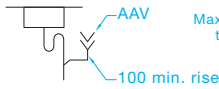
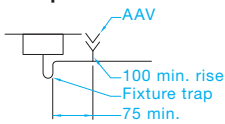

## As a Group Vent

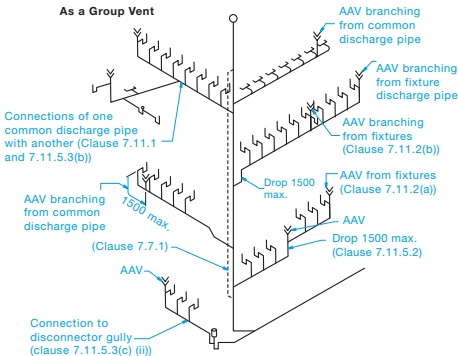

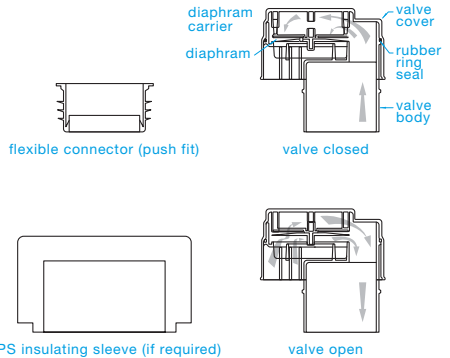

## Ventapipe Air Admittance Valve





# ABEY'S FANTASTIC PLASTIC AIR ADMITTANCE VALVES (VENTAPIPE)

PRODUCT	DESCRIPTION	SIZE	CODE	AIRFLOW CAPACITY @ -250+/- 10PA	MAX FIXTURE LOAD DISCHARGE PIPES
 <p>Dual Air Admittance Valve</p>	Enables pipes to be vented/ terminated within building	40 / 50mm	VPSF-40/50	3 litres/sec	18
 <p>Air Admittance Valve</p>	Eliminates the need for externally venting pipes	50mm	VP 50	10 litres/sec	168
 <p>Air Admittance Valve</p>	Enables pipes to be vented/ terminated within building	100mm	VP 100	45 litres/sec	250

\* Conforms to AS 2887:1993, AS/NZ 4936:2002 

APPLICATION TYPE	BASIN	BATH (WITH / WITHOUT WATER)	BIDET	SHOWER SINGLE	SHOWER MULTIPLE	SINK SINGLE OR DOUBLE	TROUGH SINGLE OR DOUBLE	WASHING MACHINE	WC FLUSH VALVE	WC CISTERN
TRAP/PIPE SIZE (MM)	40	40	40	40	50	50	50	40	80/100	80/100
FIXTURE UNIT RATING	1	4	1	2	2 / head	3	5	5	6	4

[www.abeytrade.com.au](http://www.abeytrade.com.au)



## ABEY'S FANTASTIC PLASTIC ALL-IN-ONE AAV SPEED TRAP

Abey's new S&P Speed Trap will save you time and money. By drawing air through the integrated AAV valve, the system neutralises syphonic pressure before it reaches the seal of the Trap. Therefore, it provides the equivalent of a ventilated system without the installation of costly and unsightly ventilation pipes.

- ✓ Prevents the release of foul air
- ✓ Reduces risk of syphoning
- ✓ Can be used in most internal situations
- ✓ Allows for greater design flexibility
- ✓ Used in both new and existing systems
- ✓ For single fixture unit only

### GOOD...

#### DO IT THE HARD WAY

Traditional under-sink installations require ventilation to neutralise syphon pressure and prevent release of foul air, a cumbersome exercise requiring a secondary pipe vented externally...



### BETTER...

#### DO IT THE CONVENTIONAL WAY

Reduce extensive pipework by utilising an air admittance valve inside the cabinet. But fabricating pipework in confined spaces also wastes time, energy and cupboard space...



### BEST... DO IT THE ABEY 'SPEED TRAP' WAY





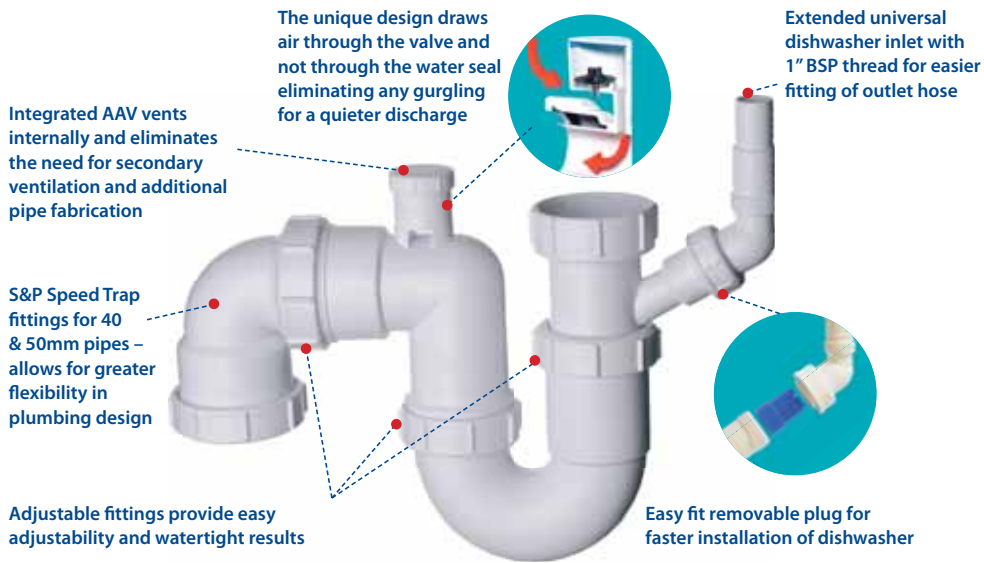

Your time is money so don't waste it by fiddling around with unnecessary pipe fabrication work. Abey's NEW S&P Speed Trap with integrated AAV solves the problem once and for all. Simpler installation, Saves Time, Saves Space, Saves Materials and lets you get on with your job faster and easier than ever before.





See instructional web video at [www.abeytrade.com.au](http://www.abeytrade.com.au)

PRODUCT	DESCRIPTION	BOX QTY	MATERIAL SIZE	AIRFLOW CAPACITY @ -250+/- 10PA	MAXIMUM FIXTURE LOAD DISCHARGE PIPES	CODE
 <p>S&amp;P Trap with AAV</p>	Incorporates inbuilt AAV to eliminate the need for external venting or pipework	1	50mm	0.3	50mm	SP50AV
 <p>S&amp;P Trap with AAV</p>	Incorporates inbuilt AAV to eliminate the need for external venting or pipework	1	40mm	0.3	40mm	SP40AV
 <p>Anti-Syphon Bottle Trap with AAV</p>	Inbuilt AAV eliminates the need for venting pipes. Compact size, adjustable, prevents foul air, low noise	1	40mm	0.3	40mm	C10AV
 <p>Reseal Bottle Trap CP</p>	Compact size, adjustable, Reseal Bottle Trap for bathrooms	1	32-40mm Chrome plated			BT40A-CP

## ABEY'S FANTASTIC PLASTIC WC CONNECTORS



Abey's fantastic plastic WC connector range are a godsend, helping plumbers solve a myriad of pan connection problems and are compatible with a variety of pipework materials including clay, cast iron and PVC-u. All Abey pan connectors incorporate all-purpose tails and fins allowing simple, watertight installation and are ideal for tolerating movement.



THE TRADESMAN'S CHOICE

[www.abeytrade.com.au](http://www.abeytrade.com.au)

# ABEY'S FANTASTIC PLASTIC WC CONNECTORS

PRODUCT	DESCRIPTION	SIZE	CODE
<b>Flexible WC Connector</b>			
	A miracle cure for awkward WC connections. The Abey Flexible WC Connector is both flexible and strong to help get you out of tight spots	<ul style="list-style-type: none"> <li>• Flexible &amp; extends 200mm to 400mm</li> <li>• Outlet Seals fit 110mm soil pipe</li> <li>• Inlet Seals fit 90mm – 118mm</li> </ul>	WC-F23R
<b>90° Space Saving Pan Bend</b>			
	Low profile Space Saving Pan Connector for use with vertical soil connections. 90° Space Saving Pan Bed with fixed Outer Fin Seals	<ul style="list-style-type: none"> <li>• Fixed Outlet Seals fit 110mm soil pipe</li> <li>• Inlet Seals fit 90mm – 118mm dia.</li> </ul>	WC-CONQ
<b>40mm Offset WC Connector</b>			
	Offset to help solve the nightmare of misaligned pipes., catering for difference between centres,	<ul style="list-style-type: none"> <li>• Fixed Outlet Seals fit 110mm soil pipe</li> <li>• Inlet Seals fit 90mm – 118mm dia.</li> </ul>	WC-CON4A
<b>WC Straight Connector</b>			
	WC Straight Connector with fixed outer seals WC Fins allow for tight seal and movement tolerances	<ul style="list-style-type: none"> <li>• Fixed Outlet Seals fit 110mm soil pipe</li> <li>• Inlet Seals fit 90mm – 118mm dia.</li> </ul>	WC-CON1
<b>MacFit Offset WC Connectors</b>			
	Universal WC Pan Connector manufactured in white EVA with synthetic rubber seals	<ul style="list-style-type: none"> <li>• 18mm offset</li> <li>• All outer seals fit inside 4"/110mm except EXTB &amp; EXTC</li> </ul>	WC-MF18A
	Universal WC Pan Connector manufactured in white EVA with synthetic rubber seals	<ul style="list-style-type: none"> <li>• 40mm offset</li> </ul>	WC-MF40A

## ABEY'S FANTASTIC PLASTIC KITCHEN SPACE SAVER KITS

Make the most of under-sink cupboard space with Abey's fantastic plastic under-sink Space Savers. Finally you can solve that age old problem that has been plaguing mankind and regain that illusive space under the sink. Abey Under Sink Space Savers move ugly and cumbersome waste pipework to the back of the cupboards to gain valuable under-sink cupboard space once and for all – Hallelujah!

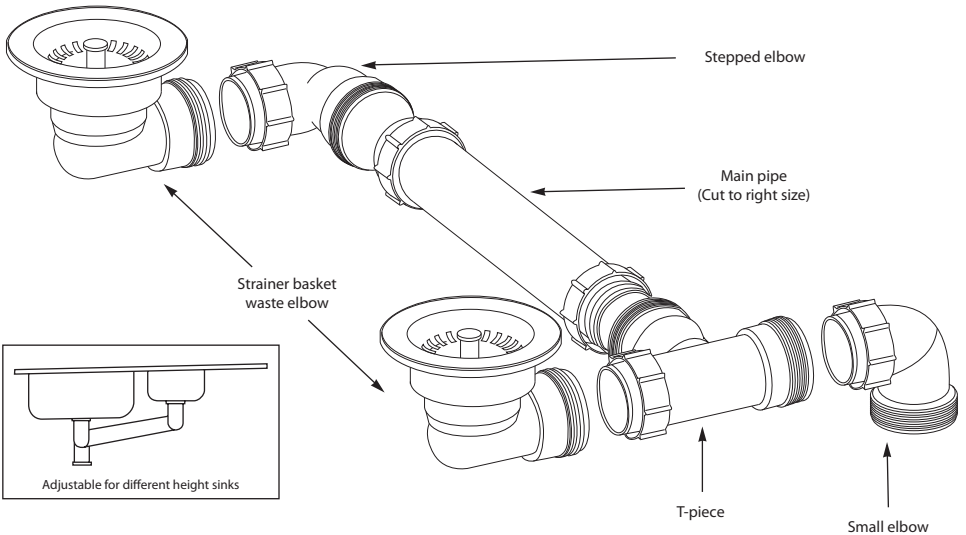



Historically under-sink cupboard space where you need it most has obstructed shelf space with ugly pipework clutter. With Abey Space Savers under-sink cupboard space has been freed up and cupboard space can finally be used for useful storage.



THE TRADESMAN'S CHOICE

[www.abeytrade.com.au](http://www.abeytrade.com.au)

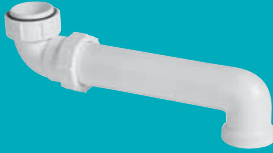
## ABEY'S FANTASTIC PLASTIC KITCHEN SPACE SAVER KITS

PRODUCT	DESCRIPTION	SIZE	CODE
 <p>Single Bowl Space Saver</p>	For bathrooms or bar installations where under sink cupboard space is a premium.	40mm – white	6074
 <p>Single Bowl Space Saver</p>	For kitchen or bar installations where under sink cupboard space is limited	50mm – white	6075
 <p>Double Bowl Space Saver</p>	Fully adjustable to compensate for different sink waste outlet configurations	40mm – white	6072

## LAUNDRY ACCESSORIES

PRODUCT	DESCRIPTION	SIZE	CODE
 <p>Reducer</p>	Reducer	50 x 40mm	T12C
	Increaser	40 x 50mm	T12E
	Plug & Waste Extension	50 x 20mm	EXT 20
	Plug & Waste Extension	50 x 45mm	EXT 45
	Plug & Waste Extension	50 x 75mm	EXT 75

Conforms to AS 2887:1993 

## ABEY'S FANTASTIC PLASTIC FLEXIBLE WASTE CONNECTORS

Abey offer a range of quality flexible connectors that are designed to help get you out of a hole. The ideal 'fix all' tool when all else fails, this range of products is a tool box for all plumbers and can help smooth out those hellish jobs that sometimes seem to go pear shaped.



### Flexible Waste Trap Connector

- ✓ Flexible plastic fitting extends to 300mm
- ✓ Universal compression fitting
- ✓ Plain Spigot fitting



### Flexible Waste Pipe Joiner

- ✓ Available in 40mm and 50mm
- ✓ Flexible & extends to approx. 400mm
- ✓ Compression pipe end fittings



### Flexible Waste Connector

- ✓ Highly Flexible & extends to over one metre
- ✓ Female Fitting – Waste Connector
- ✓ Compression – Pipe Connector





# ABEY'S FANTASTIC PLASTIC FLEXIBLE WASTE CONNECTORS

PRODUCT	DESCRIPTION	SIZE	CODE
 <p>Flexible Waste Trap Connector</p>	Your flexi friend for difficult 40mm waste trap situations	40mm – white	FLXT19UP
 <p>Flexible Waste Trap Connector</p>	Your flexi friend for difficult 50mm waste trap situations	50mm – white	FLXZ22UP
 <p>Flexible Waste Pipe Joiner</p>	Ideal solution for those difficult pipe to pipe joins	40mm – white	FLXT19UU
 <p>Flexible Waste Pipe Joiner</p>	Ideal solution for those difficult pipe to pipe connections	50mm – white	FLXT22UU
 <p>Flexible Waste Connector</p>	Plain spigot to suit multi-fit & universal compression outlet traps or waste fittings	40mm – white Length – 400 to 1000mm	FLXT40SU
 <p>Flexible Waste Connector</p>	Plain spigot to suit multi-fit & universal compression outlet traps or waste fittings	50mm – white	FLXZ40SU

Conforms to AS 2887:1993 

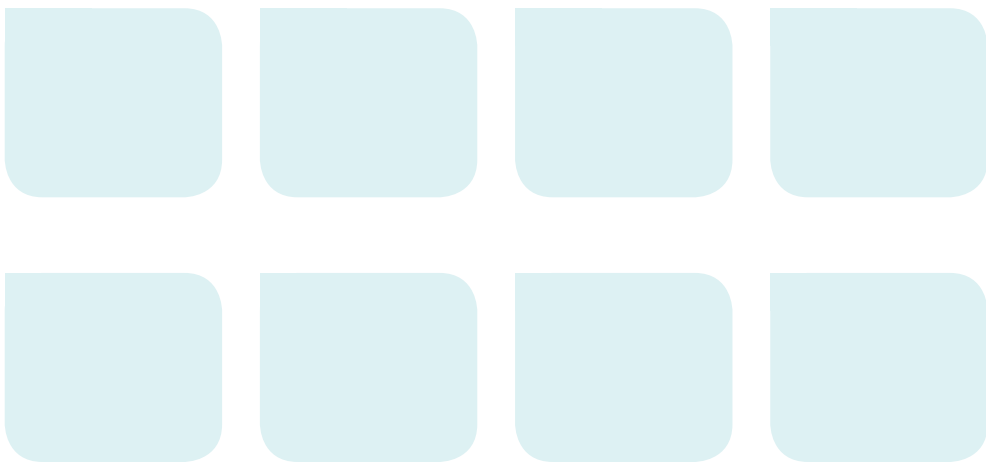

# ABEY GENERAL PLUMBING



Abey's extensive range of general plumbing products provide the quality and range plumbers demand with the back up of national support. Innovators in plumbing, Abey were the first to introduce their Easy Hooker range of flexible water and gas connectors into this nation changing the face of plumbing forever with efficiencies that continue to save plumbers time and money. Insist on Abey for all your general plumbing product needs.

## EASY HOOKERS WATER

PAGE 70



## EASY HOOKERS DISHWASHER

PAGE 71



## EASY HOOKERS GAS

PAGE 72



## ISO VALVE

PAGES 74 - 75



## COVER PLATES DWV

PAGE 76

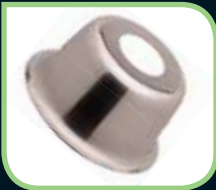

## COVER PLATES BSP

PAGES 77 - 79



## COVER PLATES COPPER

PAGES 80 - 82



THE TRADESMAN'S CHOICE

[www.abeytrade.com.au](http://www.abeytrade.com.au)

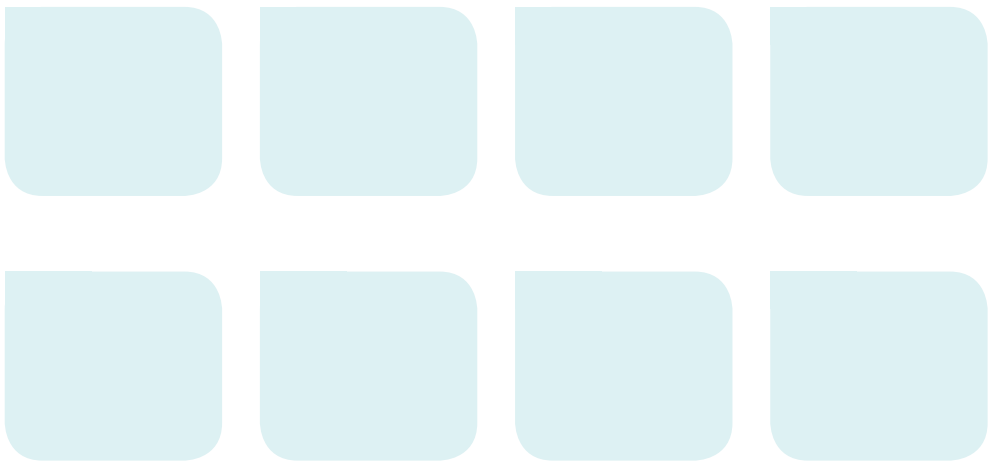

# EASY HOOKER FLEXIBLE WATER & GAS CONNECTORS



Abey is Australia's leading importer and distributor of flexible connectors and were the first company to source, introduce, distribute and communicate the benefits of this product category to plumbers throughout the nation. The product has now become a standard operational procedure for the plumbing industry and has made this process easy.



Flex Cone Hookers



Elbow Hookers



Flex Cone Olive



Flat Seats



Dish/washing  
Machine Hoses



Gas Hookers



Gas Hookers

Abey's range of Easy Hookers is the world's best of breed products utilising the highest quality materials and manufacturing to ensure that you're protected. Unlike cheap imports, Abey support their Easy Hookers nationally – so insist on Abey Easy Hookers.





# EASY HOOKER FLEXIBLE WATER CONNECTORS

PRODUCT	QTY	DESCRIPTION	SIZE	CODE
---------	-----	-------------	------	------

## Easy Hooker – Flex Cone



1 / pck	½ FL/c	8 x 225mm	AQ2400
1 / pck	½ FL/c	8 x 300mm	AQ2401
1 / pck	½ FL/c	8 x 450mm	AQ2402
1 / pck	½ FL/c	8 x 600mm	AQ2404
1 / pck	½ FL/c	8 x 1,000mm	AQ2407
1 / pck	½ FL/c	8 x 1,500mm	AQ2409S

## Elbow Hookers

### E/H Elbow Hooker

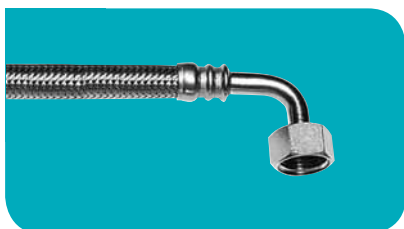

1 / pck	½ FL/C – ½ FL	8 x 255mm	AQ2580
1 / pck	½ FL/C – ½ FL	8 x 300mm	AQ2581
1 / pck	½ FL/C – ½ FL	8 x 450mm	AQ2582
1 / pck	½ FL/C – ½ FL	8 x 600mm	AQ2584

## Flex Cone – Olive 8mm Easy Hooker



1 / pck	½ Female Olive	8 x 300mm	AQ2501
1 / pck	½ Female Olive	8 x 450mm	AQ2502

## Flat Seats – 20mm Easy Hooker



1 / pck	¾ BR/F – ¾ BR/F	20 x 500mm	AQ 5043
1 / pck	¾ BR/F – ¾ BR/F	20 x 1,000mm	AQ 5047
1 / pck	¾ BR/F – ¾ BR/F	20 x 1,500mm	AQ 5049

Conforms to W251 & W212

# EASY HOOKER FLEXIBLE WATER CONNECTORS



PRODUCT	QTY	DESCRIPTION	SIZE	CODE
<b>Mixer Hose Extensions</b>				
<b>Sold on hanging cards</b>				
	1set / pck	Sold on hanging cards	Overall size 150mm long	ME150PR
	1set / pck	Sold on hanging cards	Overall size 250mm long	ME 250PR

## DISHWASHER CONNECTORS

<b>Dishwasher/ Washing Machine Hose – Stainless Steel</b>				
	1 / pck	Stainless Steel Hose ¾"	10 x 1,500mm	AQ1383
	1 / pck	Stainless Steel Hose ¾"	10 x 2,000mm	AQ1384

<b>Dishwasher/ Washing Machine Hose – Nylon</b>				
	1 / pck	Nylon Hose ¾ F – ¾ ELB	10 x 1,500mm	AQ1383N
	1 / pck	Nylon Hose ¾ F – ¾ ELB, 2m long	10 x 2,000mm	AQ1384N

Conforms to W251 & W212 

[www.abeytrade.com.au](http://www.abeytrade.com.au)



# EASY HOOKER FLEXIBLE GAS CONNECTORS

GENERAL PLUMBING

PRODUCT	QTY	DESCRIPTION	SIZE	CODE
<b>Gas Hookers ½ Female x ½ Female 10mm</b>		<b>Brass Cone 10mm ½ Female x ½ Female</b>		
	1 / pck	½ BR/C – ½ BR/CG	10 x 320mm	PN2000
	1 / pck	½ BR/C – ½ BR/CG	10 x 450mm	PN2001
	1 / pck	½ BR/C – ½ BR/CG	10 x 600mm	PN2002
	1 / pck	½ BR/C – ½ BR/CG	10 x 900mm	PN2003
	1 / pck	½ BR/C – ½ BR/CG	10 x 1,200mm	PN2005

<b>Gas Hookers ¾ Female x ¾ Female 20mm</b>		<b>Brass Cone 20mm ¾ Female x ¾ Female</b>		
	1 / pck	¾ BR/C – ¾ BR/C G	20 x 450mm	PN5001
	1 / pck	¾ BR/C – ¾ BR/C G	20 x 600mm	PN5002
	1 / pck	¾ BR/C – ¾ BR/C G	20 x 1,000mm	PN5004
	1 / pck	¾ BR/C – ¾ BR/C G	20 x 1,500mm	PN5006

<b>Gas Hookers ¾ Female x ¾ Male 20mm</b>		<b>Brass Cone 20mm ¾ Female x ¾ Male</b>		
	1 / pck	¾ BR/C – ¾ MI G	20 x 600mm	PN5012
	1 / pck	¾ BR/C – ¾ MI G	20 x 1,000mm	PN5014
	1 / pck	¾ BR/C – ¾ MI G	20 x 1,200mm	PN5015
	1 / pck	¾ BR/C – ¾ MI G	20 x 1,500mm	PN5016

Conforms to AGA5516 & AGA5588



# EASY HOOKER FLEXIBLE GAS CONNECTORS



## Easy Hookers for Water

AS3499 - Yes

Watermark - LIC. NO. W251 & W212

Date Coding - Yes

Operating Temperature - 1°C to 95°C

Liner - EPDM

Braid - 304 S/S

Ferrules - 304 S/S

Fittings - Nickel plated D.R. Brass

## Hose I.D.      Hode O.D.      Working Pressure

mm                  mm                  kPa                  PSI

8                      12                      3150                  450

10                     15                     2450                  350

15                     22                     2275                  325

20                     28                     2100                  300

26                     35                     1750                  250

32                     43                     1400                  200

40                     53                     875                    125

## Easy Hookers for town gas, natural gas & L.P. gas

AS1869 - Yes

Approval: AGASS15 & SS88

Date Coding - Yes

Liner - Nitrile

Braid - 304 S/S

Ferrules - 304 S/S

Fittings - Nickel plated Brass

Internal Spring - 15 & 20mm only

## Hose I.D.      Hode O.D.      Class      Approval

mm                  mm

8                      10                      D                      AGA5516

10                     15                     D                      AGA5516

15                     22                     B                      AGA5588

20                     28                     B                      AGA5588

Conforms to AS 2887:1993



THE TRADESMAN'S CHOICE

[www.abeytrade.com.au](http://www.abeytrade.com.au)

GENERAL PLUMBING

# ISOVALVE

IsoValve is a new product that has been invented to make plumbers lives easier, save time and increase productivity. Simply put, IsoValve is a unique isolating service valve and test plug in one. It is installed prior to wall lining so that fixtures can be installed at any time without the time wasting effort of having to turn water off and on at the mains each time – saving labour time and eliminating any inconvenience for other users. Once installed it remains in place and used to directly commission fixtures with the water on. Once connected the isolation valve is simply engaged using an allen key or small isodome.

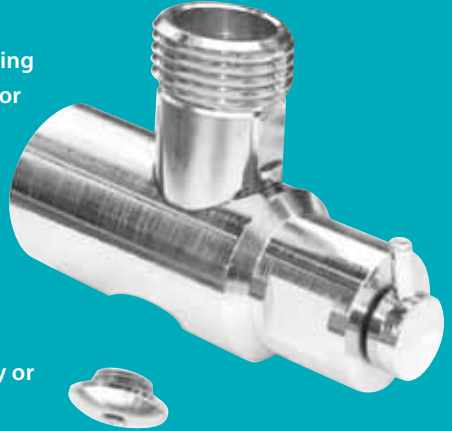

Install as you would a test plug.



Plan your unit installation with regard to finished wall thickness.



When ready to fit appliance / fixture remove protective cardboard cover and slide over flange.



Connect appliance and commission.



Install Iso-Filter and/or Iso-Adaptor if required.



Firmly hand tighten the IsoNipple and secure the O-ring seal with a spanner.



See instructional web video – [www.abeytrade.com.au](http://www.abeytrade.com.au)







# ISOVALVE

PRODUCT	DESCRIPTION	SIZE	CODE
<b>IsoValve</b>			
	Single Nipple and Cover Plate	15mm	ISO-SINGLE
	Duo Nipple and Cover Plate	15mm	ISO- DUO
	Nipple	15mm	ISO-15mm-N
	Nipple	20mm	ISO-20mm-N
	Wall Flange		ISO-WF

Conforms to AS 2887:1993 





[www.abeytrade.com.au](http://www.abeytrade.com.au)

# COVER PLATES FOR DWV PIPE



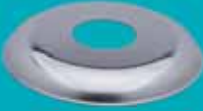



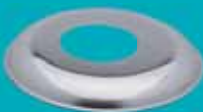

PRODUCT	QTY	DESCRIPTION	SIZE	CODE
<b>White cover plates for DWV Pipe</b>	<b>Powder Coated – White</b>			
	10 / pck	Flat	32mm	2691/10
	10 / pck	18mm rise	32mm	2692/10
	10 / pck	Flat	40mm	2693/10
	10 / pck	18mm rise	40mm	2694/10
	10 / pck	Flat	50mm	v2695/10
	10 / pck	18mm rise	50mm	2696/10

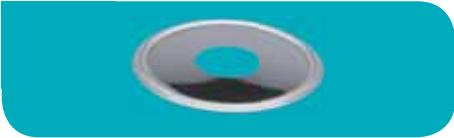

# COVER PLATES FOR BSP PIPE







PRODUCT	QTY	DESCRIPTION	SIZE	CODE
<b>Pre Packed Cover Plates for BSP Pipe</b>	<b>Chrome Plated</b>			
	50 / box 250 / box	Flat	1/2"	2641/50 2641/250
	50 / box 250 / box	9mm rise	1/2"	2642/50 2642/250
	50 / box 250 / box	15mm rise	1/2"	2644/50 2644/250
	10 / box 50 / box 250 / box	21mm rise	1/2"	2645/10 2645/50 2645/250
	10 / pck	34mm rise	1/2"	2646/10
	10 / pck	Flat	3/4"	2673/10
	10 / pck	9mm rise	3/4"	2674/10

# COVER PLATES FOR BSP PIPE



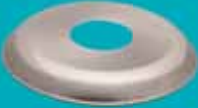



PRODUCT	QTY	DESCRIPTION	SIZE	CODE
	10 / pck	Flat	1"	2675/10
	10 / pck	Chrome Plated – 18mm rise	1"	2676/10
	10 / pck	Chrome Plated – Flat	1 ¼"	2677/10
	10 / pck	Chrome Plated – 18mm rise	1 ¼"	2678/10
	10 / pck	Chrome Plated – Flat	1 ½"	2647/10
	10 / pck	Chrome Plated – 18mm rise	1 ½"	2648/10
	10 / pck	Chrome Plated – Flat	2"	2679/10
	10 / pck	Chrome Plated – 18mm rise	2"	2680/10

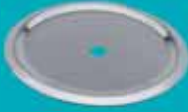

# COVER PLATES FOR BSP PIPE

PRODUCT	QTY	DESCRIPTION	SIZE	CODE
<b>Cover plates for BSP</b>		<b>White</b>		
	10 / pck	Flat	1/2"	2703/10
	10 / pck	9mm rise	1/2"	2704/10
<b>Cover plates for BSP</b>		<b>Satin</b>		
	1 / pck	9mm rise	1/2"	2700
	1 / pck	Flat	1/2"	2701
<b>Cover plates for BSP</b>		<b>Gold</b>		
	1 / pck	Flat	1/2"	2702
	1 / pck	9mm rise	1/2"	2681

# COVER PLATES FOR COPPER PIPE

PRODUCT	QTY	DESCRIPTION	SIZE	CODE
<b>Cover Plates for Copper Pipe</b>	<b>Chrome Plated</b>			
	10 / pck	Flat	1/4"	2657/10
	10 / pck	9mm rise	1/4"	2658/10
	10 / pck	Flat	3/8"	2659/10
	10 / pck	9mm rise	3/8"	2660/10
	50 / pck 250 / pck	Chrome Plated – Flat	1/2"	2661/50 2661/2500
	10 / pck 250 / pck	Chrome Plated – 9mm rise	1/2"	2662/50 2662/2500
	10 / pck 50 / pck	Chrome Plated – 12mm rise	1/2"	2684/10 2684/50







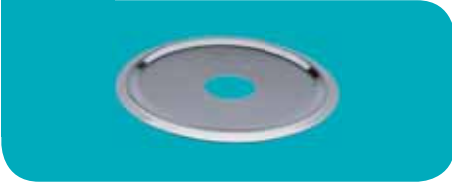
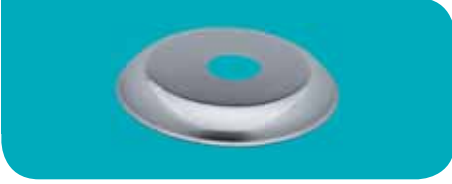
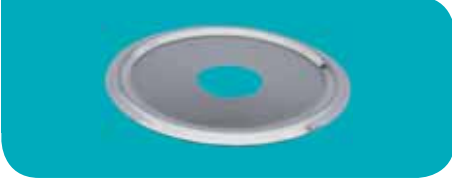
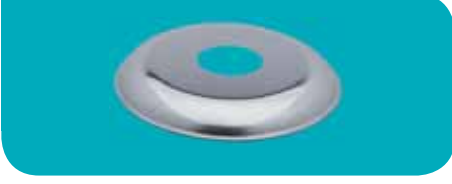
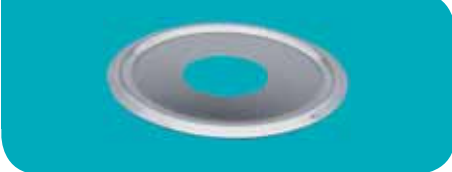

# COVER PLATES FOR COPPER PIPE

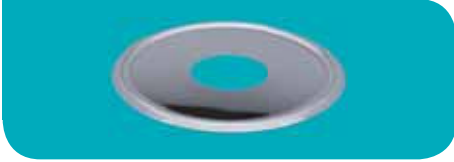
PRODUCT	QTY	DESCRIPTION	SIZE	CODE
	10 / pck 50 / pck	Chrome Plated – 16mm rise	1/2"	2685/10 2685/50
	10 / pck	Chrome Plated – Flat	5/8"	2682/10
	10 / pck	Chrome Plated – 9mm rise	5/8"	2683/10
	10 / pck	Chrome Plated – Flat	3/4"	2665/10
	10 / pck	Chrome Plated – 9mm rise	3/4"	2666/10
	10 / pck	Chrome Plated – Flat	1"	2667/10

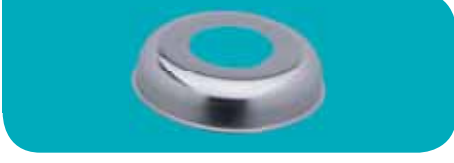
# COVER PLATES FOR COPPER PIPE

PRODUCT	QTY	DESCRIPTION	SIZE	CODE
	10 / pck	Chrome Plated – 9mm rise	1"	2668/10
	10 / pck	Chrome Plated – Flat	1 1/4"	2669/10
	10 / pck	Chrome Plated – 18mm rise	1 1/4"	2670/10
	10 / pck	Chrome Plated – Flat	1 1/2"	2663/10
	10 / pck	Chrome Plated – 18mm rise	1 1/2"	2664/10
	10 / pck	Chrome Plated – Flat	2"	2671/10
	10 / pck	Chrome Plated – 18mm rise	2"	2672/10



WANT TO FIND OUT MORE?

# VISIT THE ABEY WEBSITE

To find out more information on Abey's fantastic range of plumbing products, see our website. You'll find our helpful online catalogue as well as instructional videos, contact information, news, warranty information, free stuff and more...

Online you'll find:

- ✓ Store Locations
- ✓ Test results and Testimonials
- ✓ Product Brochures
- ✓ Instructional Videos
- ✓ Full Product Range
- ✓ Home & Designer items as well

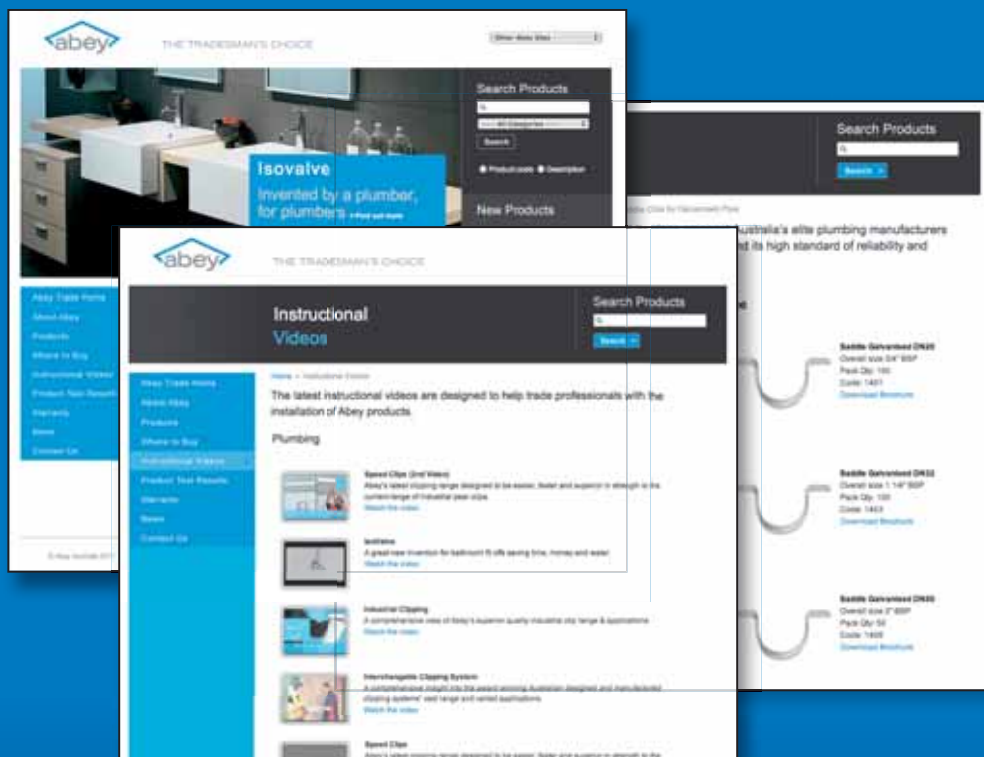

THE TRADESMAN'S CHOICE

www.abeytrade.com.au



# ABEY ROOFING



They have a range of Roof Plumbing Products that have been designed and manufactured locally to meet the needs of plumbers, using the best quality products to assure compliance to local building codes and provide long lasting performance.



## RANGEHOOD FLUE KITS

PAGE 87



## AIRFLEX

PAGE 88



## DOWNPIPE POPS

PAGE 89



## ROOF FLASHING \*

PAGES 90 - 91



## DOWNPIPE CLIPS

PAGES 92 - 93



## CRIMP BENDS

PAGES 94 - 95



## RAINHEADS

PAGE 96



## CHINA HAT COWLS

PAGE 97



## POSSOFF

PAGE 97

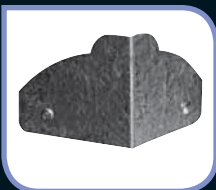

\* Roofrite products are manufactured by our New Zealand associates.

# RANGEHOOD FLUING KITS & FLUING PRODUCTS

**Hygiene** – In many homes kitchen rangehood exhausts are simply vented into the roof cavity. Over time, cooking gasses and oils expelled from a typical rangehood will build up on the surfaces inside the roof creating an unhygienic and unpleasant environment. Abey's Rangehood Flue Kits expel the cooking gasses and odours outside the house.

**Fire Safety** – The build up of grease and grime over years of cooking has the potential of being a fire hazard with the potential of fire spreading from an ignited cooking pan racing up the greasy rangehood igniting the built up grime. In situations where inferior plastic conduit may have been used, the plastic, if ignited will actually support combustion. Abey's Rangehood Flue Kits are of metal construction and will not support combustion.

**Easy Installation** – Abey Rangehood Kits contain all components necessary for easy installation. Available in all inclusive kit forms to suit most applications (vertical kits for metal & tile roofs and a horizontal kit for finishing on an external wall)

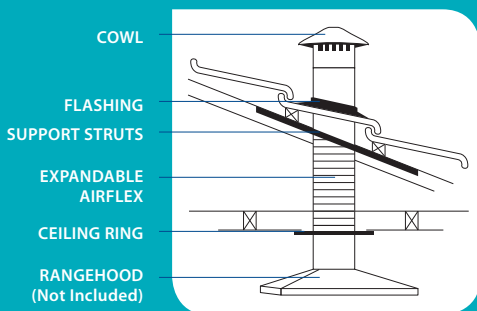

## Vertical Kit Contents

- ✓ 3.4 metres of Airflex + pipe
- ✓ Cowl
- ✓ Roof flashing
- ✓ Ceiling ring
- ✓ Angle support struts (2)

## Horizontal Kit Contents

- ✓ 3.4 metres of Airflex
- ✓ External wall vent (Auto Close)
- ✓ Ceiling ring

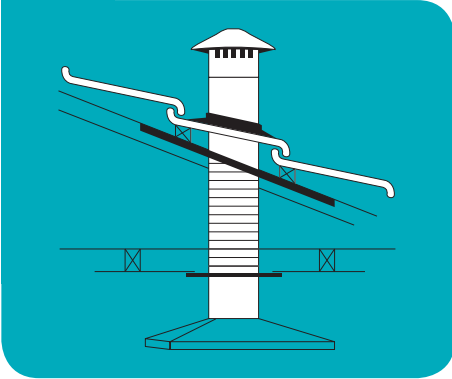
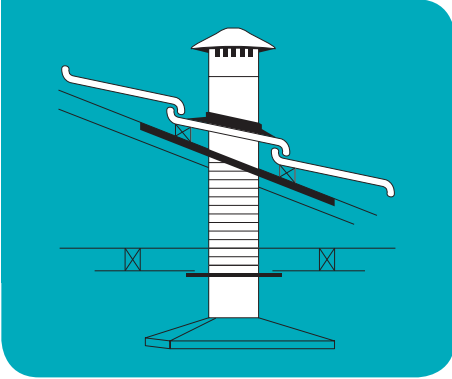
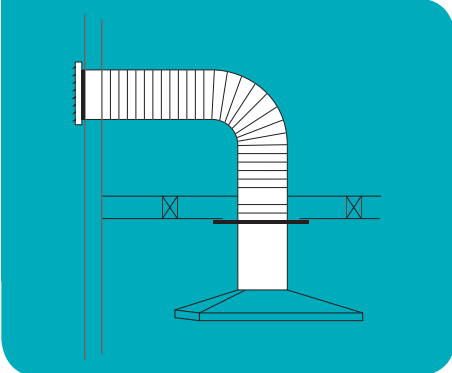

# RANGEHOOD FLUING KITS & FLUING PRODUCTS

PRODUCT	DESCRIPTION	FLUE SIZE DIAMETER	CODE
	For Tiled Roof	125mm	RHVT5
	<b>Kit contains:</b> <ul style="list-style-type: none"> <li>• 3.4m Airflex + pipe</li> <li>• Cowl</li> <li>• Roof flashing</li> <li>• Ceiling Ring</li> <li>• Support Struts (2)</li> </ul>	150mm	RHVT6
	For Steel Roof	125mm	RHVS5
	<b>Kit contains:</b> <ul style="list-style-type: none"> <li>• 3.4m Airflex + pipe</li> <li>• Cowl</li> <li>• Roof flashing</li> <li>• Ceiling Ring</li> <li>• Support Struts (2)</li> </ul>	150mm	RHVS6
	For Wall (horizontal)	125mm	RHH5
	<b>Kit contains:</b> <ul style="list-style-type: none"> <li>• 3.4m Airflex + pipe</li> <li>• External Wall Vent (autoclose)</li> <li>• Ceiling Ring</li> </ul>	150mm	RHH6

Conforms to AS 2887:1993 

[www.abeytrade.com.au](http://www.abeytrade.com.au)

# ABEY EXPANDABLE AIRFLEX RANGEHOOD FLUE

PRODUCT	QTY	DESCRIPTION	OVERALL SIZE	CODE
<b>Airflex</b>				
	12 / box	Airflex	100mm x 3m	100AF3000
	66 / box	Airflex	100mm x 3m	100AF3000B
	8 / box	Airflex	125mm x 3m	125AF3000
	45 / box	Airflex	125mm x 3m	125AF3000B
	6 / box	Airflex	150mm x 3m	150AF3000
	28 / box	Airflex	150mm x 3m	100AF3000B
	6 / box	Airflex	200mm x 3m	200AF3000

Conforms to AS 2887:1993 





# ROOF PLUMBING PRODUCTS

## DOWNPIPE POPS

PRODUCT	QTY	DESCRIPTION	SIZE	CODE
<b>Downpipe Pops – Round</b>				
	20 / box	Zincalume	50mm	1952Z
	20 / box	Zincalume	65mm	1953Z
	20 / box	Zincalume	75mm	1944Z
	20 / box	Zincalume	90mm	1955Z
	20 / box	Zincalume	100mm	1946Z
<b>Downpipe Pops – Square</b>				
	30 / box	Zincalume	100 x 50mm	1958Z
	30 / box	Zincalume	100 x 75mm	1959Z
	20 / box	Zincalume	100 x 100mm	1960Z

[www.abeytrade.com.au](http://www.abeytrade.com.au)

## ROOF PLUMBING PRODUCTS ABEY ROOFTITE PIPE FLASHING

Abey's Rooftite pipe flashings are available in EDPM and Silicon for high temperature applications up to 200°C, for pipes sizes up to 375mm. This unique solution has been designed with a patented oval base mirroring the hole cut. The design covers a larger range of pipe size with only a handful of units needing to be carried.



**Moulded Base Ribs** – Provides easier deformation and excellent sealing.



**Patented Oval Base** – Mirrors hole cut, especially valuable in steep pitched roofs.



**Twin Pleats** – More flexibility reduced stress especially for steep roofs.



**Reduced Flashing width** – Allows for better water flow.



**Better Sizing** – Each flashing accommodates a greater range of pipe diametres. EDPM & Silicon – Available in standard & hi temperature silicon 200oC.



**Moulded O Rings** – Internally moulded provides greater strength and seal around pipe.

## ROOF PLUMBING PRODUCTS

# ABEY ROOFTITE PIPE FLASHING

PRODUCT	QTY	DESCRIPTION	SIZE	CODE
<b>Roofrite Roof Flashing</b>	<b>Black</b>			

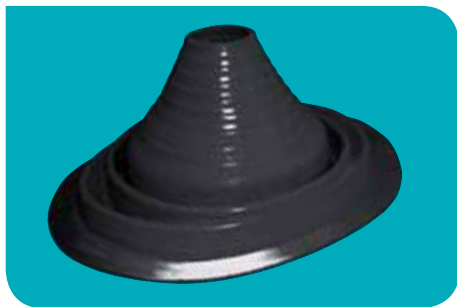

1 / pck	Black	0 – 35mm	0 – 35G
1 / pck	Black	35 – 70mm	0 – 70G
1 / pck	Black	50 – 155mm	50 – 155G
1 / pck	Black	150 – 255mm	150 – 255G
1 / pck	Black	240 – 375mm	240 – 375G

<b>Roofrite Roof Flashing</b>	<b>Silicon</b>			
-------------------------------	----------------	--	--	--



1 / pck	Terracotta colour	0 – 70mm	0 – 70S
1 / pck	Terracotta colour	50 – 155mm	50 – 155S
1 / pck	Terracotta colour	150 – 255mm	150 – 255S
1 / pck	Terracotta colour	240 – 375mm	240 – 375S







Conforms to AS 2887:1993 

[www.abeytrade.com.au](http://www.abeytrade.com.au)

# ROOF PLUMBING PRODUCTS

## DOWNPIPE CLIPS

PRODUCT	QTY	DESCRIPTION	SIZE	CODE
<b>Downpipe Clips – Round</b>		<b>Zincalume</b>		
	20 / box	Zincalume	50mm	1912Z
	20 / box	Zincalume	65mm	1913Z
	20 / box	Zincalume	75mm	1914Z
	20 / box	Zincalume	90mm	1915Z
	20 / box	Zincalume	100mm	1916Z
<b>Downpipe Clips – Square</b>		<b>Zincalume</b>		
	25 / box	Zincalume	100 x 50mm	1918Z
	25 / box	Zincalume	100 x 75mm	1919Z
	25 / box	Zincalume	100 x 100mm	1920Z

# ROOF PLUMBING PRODUCTS

## DOWNPIPE CLIPS

PRODUCT	DESCRIPTION	SIZE	CODE	
<b>Downpipe Clip – Square</b>	<b>Powdercoated</b>			
	25 / box	Powdercoated	100 x 50mm	1931Z

PRODUCT	DESCRIPTION	SIZE	CODE	
<b>Downpipe Clip – Square</b>	<b>Colourbond Colours (see below for colours)</b>			
	10 / box	(see below)	100 x 50mm	1918CB

	10 / box	(see below)	100 x 75mm	1919CB
---	----------	-------------	------------	--------



Available in the following Colours:

SURFMIST	WINDSPRAY	IRONSTONE	DEEP OCEAN	EVENING HAZE	PALE EUCALYPT	WILDERNESS	COTTAGE GREEN	SHALE GREY	SANDBANK	JASPER	LOFT	CLASSIC CREAM	PAPERBACK	HEADLAND	MANOR RED	DUNE	BUSHLAND	WOODLAND GREY	MONUMENT

[www.abeytrade.com.au](http://www.abeytrade.com.au)

# ROOF PLUMBING PRODUCTS

## CRIMP BENDS

PRODUCT	DESCRIPTION	SIZE	CODE
45° Crimp Bends	Single Flue Accessories		
	Galvanised	50mm	2621
	Galvanised	65mm	2622
	Galvanised	75mm	2623
	Galvanised	100mm	2624
	Galvanised	125mm	2625
	Galvanised	150mm	2626
	Galvanised	200mm	2627



THE TRADESMAN'S CHOICE



# ROOF PLUMBING PRODUCTS

## CRIMP BENDS

PRODUCT	DESCRIPTION	SIZE	CODE
<b>90° Crimp Bends</b>	<b>Single Flue Accessories</b>		
	Galvanised	50mm	2631
	Galvanised	65mm	2632
	Galvanised	75mm	2633
	Galvanised	100mm	2634
	Galvanised	125mm	2635
	Galvanised	150mm	2636
	Galvanised	200mm	2637
			
<b>45° Crimp Bends</b>	<b>Zincalume</b>		
	Zincalume	75mm	2623Z
	Zincalume	100mm	2624Z
			
<b>90° Crimp Bends</b>	<b>Zincalume</b>		
	Zincalume	75mm	2633Z
	Zincalume	100mm	2634Z

## ROOF PLUMBING PRODUCTS RAINHEADS

PRODUCT	DESCRIPTION	SIZE	CODE
<b>Rain Heads</b>			
	Zincalume	200 x 175 x 200	2541
	Zincalume	275 x 175 x 200	2542
	Zincalume	400 x 175 x 200	2543
	Zincalume	300 x 225 x 225	2544
	Zincalume	500 x 225 x 225	2545
	Zincalume	450 x 300 x 300	2546
	Zincalume	500 x 300 x 300	2547

Conforms to AS 2887:1993 



# ROOF PLUMBING PRODUCTS

## CHINA HAT COWLS

PRODUCT	DESCRIPTION	SIZE	CODE
<b>China Hat Cowls</b>			
	With Bird Proofing	75mm	2501
	With Bird Proofing	90mm	2502
	With Bird Proofing	100mm	2503
	With Bird Proofing	125mm	2505
	With Bird Proofing	150mm	2507
	With Bird Proofing	175mm	2508
	With Bird Proofing	200mm	2509
	With Bird Proofing	225mm	2510
	With Bird Proofing	250mm	2511
	With Bird Proofing	275mm	2512
	With Bird Proofing	300mm	2513



## POSSOFF

Possums, birds & other vermin can be destructive when they get into your roof. Bird nests can even be a fire hazard. But you can stop these pests with **Abey's PossOff**.



With guttering removed, you can see the potential entry point.



Simply by installing Abey's PossOff, entry points are protected.



6 / pck

PossOff

[www.abeytrade.com.au](http://www.abeytrade.com.au)

## NOTES

## NOTES

*The*  
Plumbers



Please note that the products and descriptions depicted in this bible are correct at time of printing but may in time vary. Installation of plumbing products should be carried out by a licensed plumber in accordance to the relevant building codes in your area. This document may not be reproduced in whole or in part without the written consent of Abey Australia Pty Ltd.

**DISCLAIMER:**

The information in this publication has been assembled for guidance only. Care has been taken to ensure accuracy, but no liability can be accepted for any consequence which may arise as a result of its application.



THE TRADESMAN'S CHOICE

57-81 Abey Road, Melton 3337, Victoria, Australia Phone: 1800 809 143

[www.abeytrade.com.au](http://www.abeytrade.com.au)