

ASSEMBLY INSTRUCTION FOR EXC-900 SHELF



WARNING

Serious or fatal crushing injuries can occur from furniture tip over. To prevent this furniture from tipping over it must be permanently fixed to the wall with the included wall attachment devices.

When attaching unit to wall put safety bracket in middle of unit with 5/8 pan screw then 25mm pan head screw into wall. For plasterboard without a stud it is recommended to use a plug with screw (not provided).



2000mm H x 900mm W x 450mm D

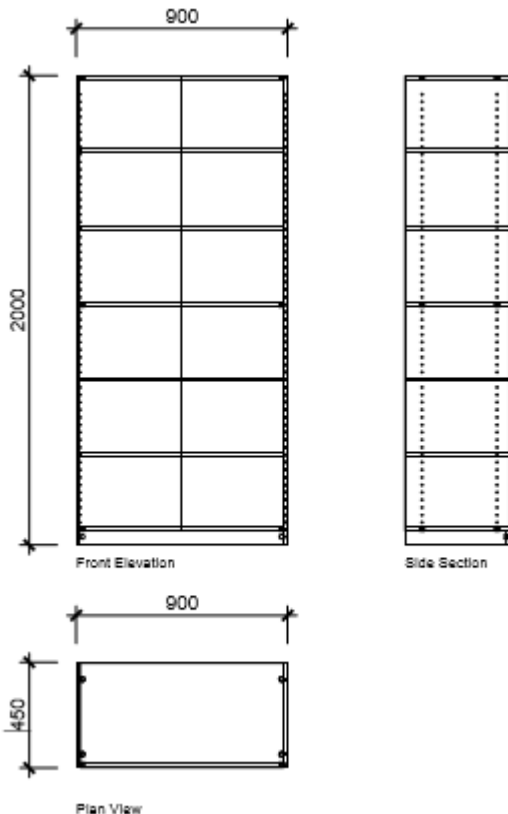

PARTS IDENTIFICATION LIST







EXC-900 SHELF

Height: 2000 Width:900 Depth: 450

- 1) Left Gable: 446 x 1999
- 2) Right Gable: 446 x 1999
- 3) Top: 444 x 868
- 4) Base: 444 x 868
- 5) Kick face: 868 x 60
- 6) Cam Shelf: 444 x 868
- 7) Adjustable Shelves: 444 x 868
- 8) Back: 450 x 1938
- 9) Back: 450 x 1938

	CAM HEADS	14
	CAM PINS	14
	BACKING NAILS	75

	5/8 PANHEAD WALL SCREWS	1
	25mm PANHEAD UNIT SCREWS	1
	"L" SAFETY BRACKET	1
	SHELF SUPPORT PINS	16

ASSEMBLY OF SHELL OF EXC-900 SHELF

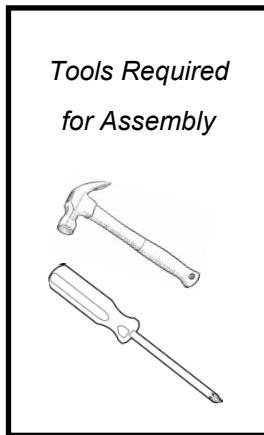
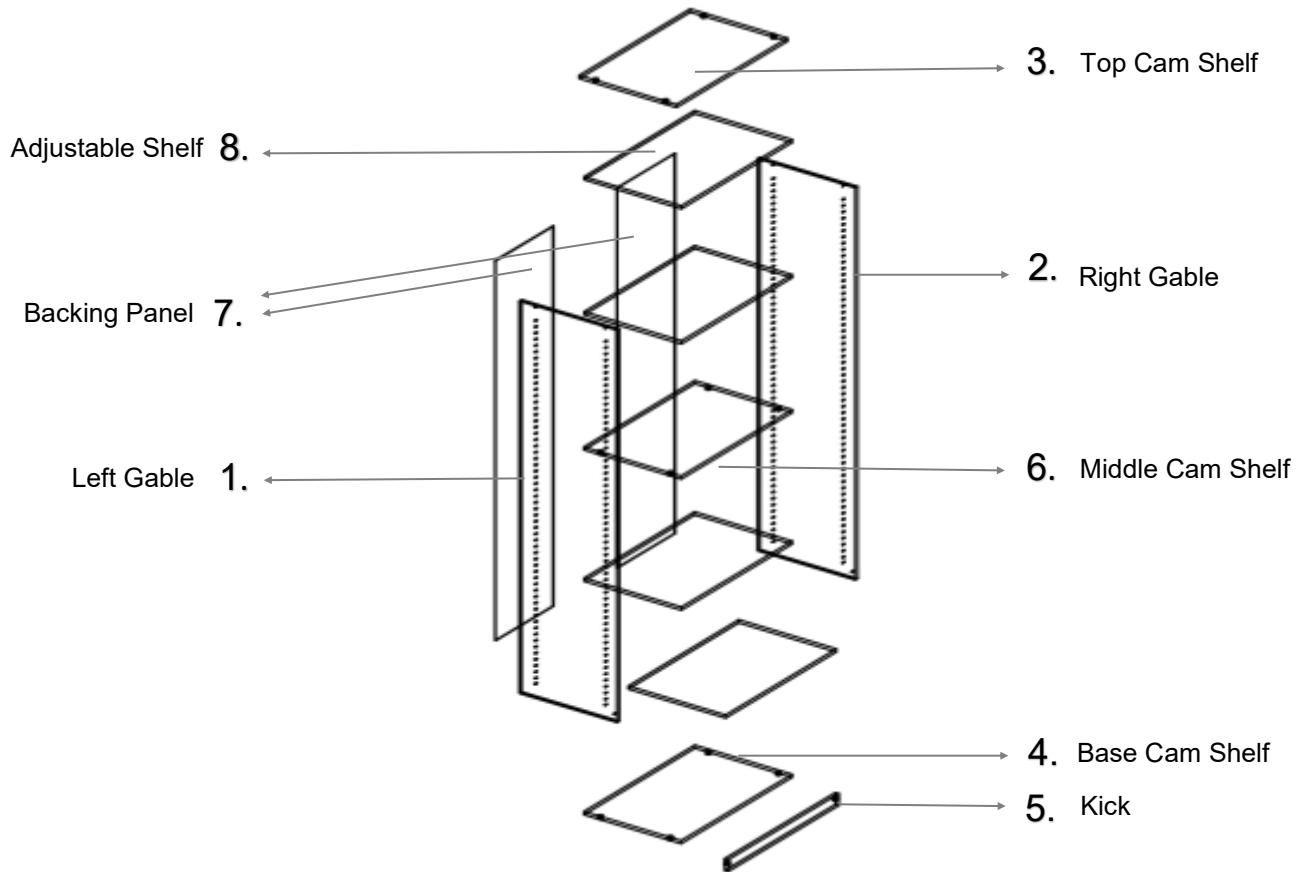

Step 1: Lay all panels on the floor to assemble.

Step 2: Secure Left Gable (1) to Top Shelf (3), then the Base Shelf (4) and then follow with the Cam Middle Shelf (6).

Step 3: Ensure all Shelves are attached to the Left Gable, then secure the Right Gable (2) to all 3 Shelves. Ensure you follow the below cam instructions and use 4 x Cam Locks and Pins per shelf.

Step 4: When this is all completed add the Kick Face (5) to the Base Shelf (4).

INSTALLING CAM LOCK FIXINGS

1. Use a rubber mallet to tap cams into pre-drilled holes on panels. Ensure cam opening is square with the edge of the board.

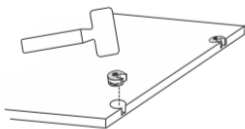

2. Use a Phillips head screwdriver to fit cam pins in corresponding panel

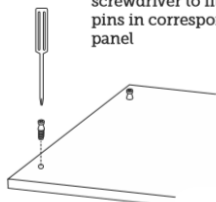

3. Push cam onto cam pin as shown.

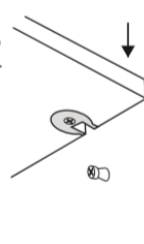

4. Once in place tighten cam grub screw by using a Phillips head screwdriver.

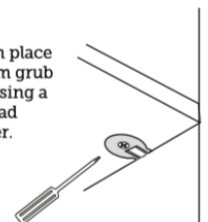

ASSEMBLY BACKING BOARD

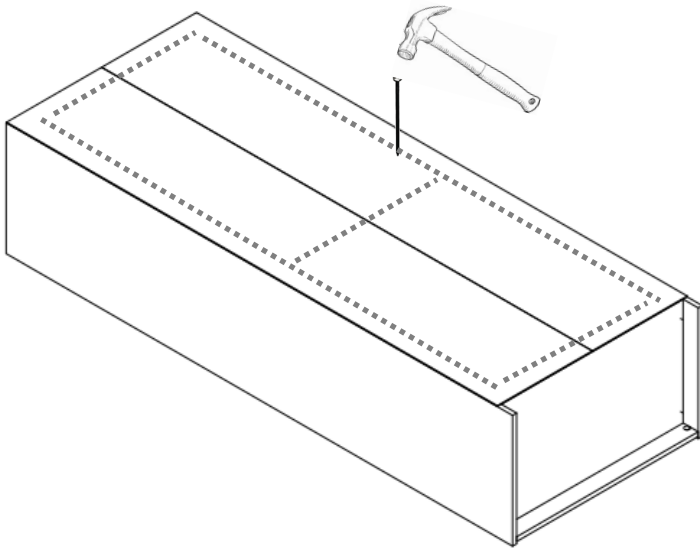

Step 5: Fold out the Backing Boards (7) proceed to nail the Backing Board into position with a hammer.

It is important to make sure the Backing Boards are square with the left and right gables.

To secure the middle add a few nails across the Middle Cam Shelf.

ASSEMBLY ADJUSTABLE SHELF



Shelf Support Pins

Step 6: Tap Shelf Support Pins into predrilled holes quantity 4 x Shelf Support Pins are required per Adjustable Shelf (8).

Repeat for each shelf at what ever height that suits.