

jumbuck®

MONTH
12
WARRANTY

Circa Portable Hotplate BBQ 45cm Round Cast Iron Hotplate

- Cooking Surface 450mm Diameter Hotplate
- Steel Windshield With Powder Coated Finish
- Powder Coated Steel Legs
- Stainless Steel Burner
- Suitable For 2kg Gas Bottle Only
- AGA Gas Certified
- Universal LPG Only
- Gas Hose Included
- Dimensions: D460xH810mm



Burner



Burner
Material



Cast Iron
Cooking
Plate

Univesal LPG Only



jumbuck

ASSEMBLY & OPERATION INSTRUCTIONS JUMBUCK CIRCA (HS-A16o)



**FOR
OUTDOOR
USE ONLY**

FOR YOUR SAFETY

If you smell gas:

1. Shut off gas to the appliance.
2. Extinguish any open flame.
3. If odour continues, immediately call your gas supplier.

FOR YOUR SAFETY

1. Do not store or use gasoline or other flammable vapours or liquids in the vicinity of this or any other appliance.
2. A gas cylinder not connected for use shall not be stored in the vicinity of this or any other appliance.



- For outdoor use only.
- Improper installation, adjustment, alteration, service or maintenance can cause property damage, injury or death.
- Read the installation, operating and maintenance instructions thoroughly before installing or servicing this equipment.
- Warning: accessible parts may be very hot. Keep young children away.
- Do not move the appliance during use.
- Turn off the gas supply at the gas cylinder after use.
- Any modification of the appliance may be dangerous and will void the warranty.
- Installer to leave instructions with the consumer and consumer to retain them for future reference.
- Please ensure all packaging and transit protection materials are removed prior to using the BBQ.

IMPORTANT! PLEASE READ THESE INSTRUCTIONS CAREFULLY BEFORE USE!

USE 2KG GAS CYLINDER ONLY

UNIVERSAL LPG GAS ONLY



jumbuck

SAFETY INSTRUCTIONS

IMPORTANT: READ THE ASSEMBLY INSTRUCTIONS IN THIS BOOKLET BEFORE REMOVING THE CONTENTS OF THIS CARTON

IMPORTANT SAFETY INSTRUCTIONS

This appliance must only be used in an above ground open-air situation with natural ventilation, without stagnant areas, where gas leakage and products of combustion are rapidly dispersed by wind and natural convection

- This BBQ is an **outdoor appliance only**. Under no circumstances should it be use indoors.
- READ ALL OPERATING INSTRUCTION BEFORE LIGHTING
- Do not perform any servicing on the BBQ yourself. This includes internal adjustment of the regulator and gas valves. Servicing can only be carried out by authorized technicians.
- When gas cylinder is replaced or reconnected, check for leaks.
- Do not store chemicals or flammable materials near this appliance.
- Unsupervised children should not be near a BBQ while cooking or during warm up or cool down.
- People with flammable clothing such as nylon etc. should keep well away from the BBQ when it is operating.
- Do not leave food unattended on the BBQ.
- In case of fat fire, turn gas cylinder off.
- Particular care must be taken when removing oil cup or drip tray. Hot oil can cause serious injury.

- This BBQ should not be located under overhead combustible construction and proper clearances must be maintained at all times from combustible construction and/or materials, with **MINIMUM** clearances as follow:

From Sides	450mm
From Back	450mm
High	1000mm

- Turn all gas valves off including gas cylinder after use.
- Never leave burner on high for more than 10 minutes unless actually cooking. If the burner makes hissing sound when lit, it may be burning inside. Turn burner off, allow it to cool and try again.
- Do not allow build up of unburned gas.
- Oil cup needs to be cleaned regularly to prevent excessive fat or grease build up that might contribute to a fire.



DO NOT	OPERATE THIS APPLIANCE BEFORE READING THE INSTRUCTION BOOKLET
DO NOT	PLACE ARTICLES ON OR AGAINST THIS APPLIANCE
DO NOT	STORE CHEMICALS OR FLAMMABLE MATERIALS OR SPRAY AEROSOLS NEAR THIS APPLIANCE
DO NOT	OPERATE THIS APPLIANCE INDOORS
DO NOT	ENCLOSE THIS APPLIANCE
DO NOT	LIGHT OR OPERATE WITH THE COVER ON(COVER NOT INCLUDED)

WARNING

A strong gas smell or the hissing sound of gas indicates a serious problem with your gas BBQ or the gas cylinder. Failure to immediately follow the steps listed below could cause serious bodily injury, death, or property damage.

- Shut off gas supply to the gas BBQ.
- Put out any flame with a class B fire extinguisher.
- Get away from the gas cylinder.
- Do not try to fix the problem yourself.

If odour continues or you have a fire you cannot extinguish, call your fire department. Do not call near the gas cylinder because your telephone is an electrical device and could create a spark resulting in fire and/or explosion.

NOTE: The normal flow of gas through the regulator and hose assembly can create a humming sound. A low volume of sound is perfectly normal and will not interfere with operation of the BBQ. If humming sound is loud and excessive you may need to purge air from the gas line or reset the regulator excess gas flow device. This purging procedure should be done every time a new gas cylinder is connected to your BBQ.

OTHER CONSIDERATIONS

- Strong winds and low temperatures can affect the heating and performance of your gas BBQ so factor in these elements when positioning your BBQ outdoors for cooking.
- Never use your gas BBQ in a garage, porch, shed, breezeway or any other enclosed area.
- Your gas BBQ is to be used outdoors only, at least 45cm from the back and side of any combustible surface. Your BBQ should not be placed under any surface that will burn.
- Do not obstruct the flow of ventilation air around the gas BBQ housing. This gas BBQ is not intended to be installed in or on recreational vehicles and/or boats.

INSTALLATION COMPLIANCE

This appliance must be installed in accordance to the installation instructions provided by the manufacturer, local gas fitting regulations, municipal building codes, AS5601 / AG 601 gas installation codes and any other relevant statutory regulations

PLACEMENT OF BBQ

PLACEMENT OF BBQ

- This product is meant for outdoor use only! Do not store petrol or any inflammable liquids near this product.
- Always place the gas cylinder beside the BBQ when not in use. Some models have room for a gas bottle underneath the burner – this is only to be used when the BBQ is cold!

ANY ENCLOSURE IN WHICH THE APPLIANCE IS USED MUST COMPLY WITH ONE OF THE FOLLOWING:

An enclosure with walls on all sides, but at least one permanent opening at ground level and no overhead cover. Within a partial enclosure that includes an overhead cover and no more than two walls. Within a partial enclosure that includes an overhead cover and more than two walls, the following shall apply-

- i. at least 25% of the total wall area is completely open; and
- ii. at least 30 %of the remaining wall area is open and unrestricted.

In the case of balconies, at least 20% of the total of the side, back and front wall areas shall be and remain open and unrestricted.

NOTE:

Wrongful installation, adjustments and changes, or lack of service and maintenance could cause damage to individuals or materials. It is therefore important to carefully read the instructions on how to install, use and maintain the product before assembling the item. The BBQ must be installed according to national/local regulations. Make sure that the gas hose is not clenched, and never in contact with hot surfaces, and that the BBQ is installed in exact accordance with these instructions. For service, please contact authorized personnel. Always ensure that the BBQ is placed away from inflammable material when being used. When lighted, the BBQ must be kept under surveillance at all times. Keep children at a safe distance from the BBQ; touching hot surfaces could cause burns. The BBQ must be kept clean to avoid flare-ups caused by remnants of fat. Fires resulting from ignition of grease will void the warranty. Ensure that the gas cylinder is suitable for your product.

Outdoor area example 1

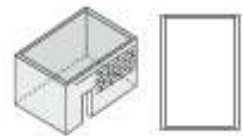

Outdoor area example 2



Outdoor area example 3



Outdoor area example 4

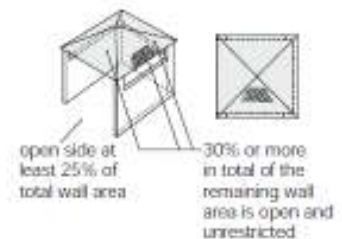

Outdoor area example 5

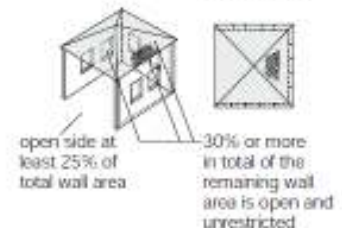

GAS CYLINDER SAFETY INFORMATION

GAS TYPE

Note the labeling of appropriate gases listed on your BBQ and ascertain that the gas you have is suitable for your BBQ. Be aware that several different valves for gas cylinders exist, and that the regulator must connect appropriately to your gas cylinder.

GAS CONNECTION

- Never try forcing the gas cylinder valve to fit the gas hose.
- Never make adjustments to low-pressure regulator and hose coupling.
- The gas hose must be inspected for signs of damage/leakage prior to being used. If any of these parts are being replaced, use only parts specified by the manufacturer.
- The gas hose should be secured by using hose clamps, which are tightened with the use of a screw driver.
- Do not secure any attachments with tape, or similar materials not meant for gas applications.
- When the gas cylinder is not in use, it must be turned off and disconnecting the gas hose is advisable.

GAS HOSE REPLACEMENT

In the case of a problem arising with the gas hose, please contact your BBQ supplier for a list of approved replacement parts. The gas hose must comply to Australian gas standards.

GAS CYLINDER STORAGE

Gas cylinder not in use are to be stored outdoors in a well ventilated place, out of reach from children. Make sure that the gas cylinder is placed in an upright position and on an evenly surfaced ground. Additional gas cylinder are not to be stored underneath or in proximity to the BBQ.

SAFETY WHEN LEAKAGE OF GAS IS SUSPECTED

- Turn off the BBQ's gas supply and disconnect the gas hose from the gas cylinder.
- Wipe out any open flames and remove possible ignition sources. If the smell of gas is sustained, please contact your gas supplier or the fire department immediately.
- If the gas cylinder appears to be the source of smell/leakage, place this outdoor with good ventilation and away from possible ignition sources



WARNING

**STORE GAS CYLINDER IN A WELL VENTILATED AREA
OUT OF REACH OF CHILDREN**

LEAK TESTING

Please check for gas leakage the first time you are connecting the BBQ to the gas cylinder, and also each time you are replacing the gas cylinder or disconnecting/reconnecting any fittings. Inspect the hose before each use.

To check for gas leakage, turn on the gas supply at the gas cylinder. Caution – gas will flow from the burner as soon as the cylinder valve is opened, as this valve also controls the burner operation. Pour soapy water solution over the cylinder connections. Any gas leakage should result in bubbles appearing immediately. If a gas leakage is detected, tighten the connection and recheck for leaks. If the gas leakage persists, turn off the gas supply and contact your supplier or place of purchase. As an alternative, you may use a gas leak detector, following the manufacturer's instructions, available at all major BBQ retailers. This provides an easier way to check for gas leaks. Do not use the appliance until the gas leak has been rectified.

DO NOT USE NAKED FLAME FOR LOCATING GAS LEAKS. IF A LEAK PERSISTS, TURN OFF GAS CYLINDER VALVE AND CALL AN AUTHORISED PERSON

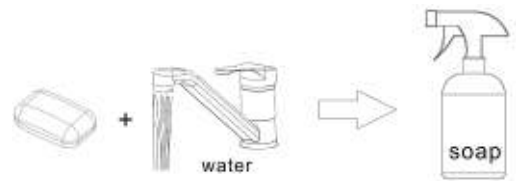

1. Add soap and water to spray bottle or soapy water with brush



2. Turn gas cylinder on

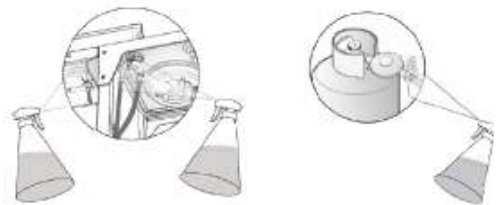

3. Spray or apply soapy water on gas connections

4. If leak is present, bubbles will appear

IMPORTANT INFORMATION REGARDING THIS BBQ- CIRCA HS-A16o BBQ

- This BBQ is only **SUITABLE WITH 2KG GAS CYLINDER ONLY**
- This is a single burner BBQ **WITHOUT** a built-in gas control valve **AND** ignition.
- Gas flow is controlled via the gas cylinder valve located on the gas cylinder.
- **CAUTION!** Gas will flow through the burner as soon as the gas cylinder valve is opened.
- This BBQ is to be lit manually using matches or similar lighting equipment.

LIGHTING PROCEDURE

- Lighting the BBQ is easy, but must be done with due care.
- Make sure that gas is turned off at the cylinder.
- Check that gas hose is connected to the gas cylinder.
- Make sure the gas cylinder is filled.
- Make sure all gas connections are securely tightened and leak tested.
- Keep your hand below the bottom of the burner when lighting the burner.
- Place a lighted match or gas lighter (not provided). Please see illustration below

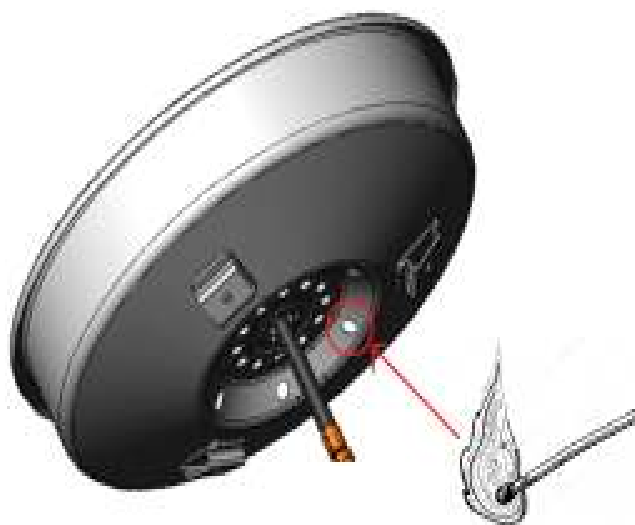

- Turn gas cylinder valve on.
- You should see the burner alight.

TURNING OFF THE BBQ

- To turn BBQ off, close the gas cylinder valve on the gas cylinder.

NOTE

If the burner does not light after 5 seconds, turn the gas cylinder off and wait for 2 minutes. Repeat lighting procedure. If the burner fails to light after several attempts, please contact your an authorised person.

FIRST TIME USE - CURING THE PLATE

During manufacturing, the cooking surface is coated with a non-toxic paint. This paint will come off completely over time. Its purpose is purely to help protect your BBQ during transport and storage.

Coat the cooking surface with canola oil or cooking oil. Light the BBQ. Leave the BBQ with the burner on low for about 30 minutes. Paint may come off at this time. After cleaning, the cooking surface is now cured and ready for use. This process only needs to be done the first time you use the BBQ

PREPARING THE COOKING SURFACE

It is recommended to coat the cooking surface with cooking oil before lighting as this will help keep the food from sticking to the cooking surface. Turn on the burner and leave them burning at a low temperature ("LOW") to preheat the cooking surface

WHILE COOKING

Flames caused by fat dripping from the food could damage the food, causing the food to burn easily. Remove excess fat from the meat if this becomes a problem. Removing the meat from the flames is also advisable. Always monitor your cooking and avoid leaving the BBQ unattended while cooking.

AFTER COOKING

To turn the BBQ off, it is best to turn off the cylinder first, and allow all the gas remaining in the hose to burn off, this will only take a couple of seconds.

OIL CUP

Oil cup must be cleaned regularly and checked each time before use. Always empty oil cup before each use. Overflow of the oil cup might cause serious burns or injuries. Never touch the oil cup until the BBQ and fat have cooled down completely.

COOKING SURFACE MAINTENANCE

Burning at maximum heat for approximately 5-10 minutes is recommended after each use to clean the cooking surface. Remnants of food and grease can then be removed using a brush. You should use an oven mitt to avoid burning yourself. Then recoat the plate with cooking oil for continued protection.

NOTE: The cooking surface should be coated with cooking oil if the BBQ is not to be used for a longer period of time. Failure to do this will result in a layer of rust on the surface.

CARING FOR THE BBQ

Your BBQ should be kept clean to prevent deterioration and it will look better and last longer if you keep the BBQ clean.

The BBQ should be regularly cleaned and be protected by a fitted cover when not in use. Clean the BBQ thoroughly on a regular basis, and cover it with a thin layer of neutral oil (acid free oil).

Grease can build up on the frame itself. Most of it can be cleaned off with hot water. Use a non-caustic cleanser for more stubborn stains.

Movable parts such as the hinges, wheel nuts and doors should be sprayed with a lubricant.

REMINDER

Always ensure that the appliance has cooled down before cleaning. Hot surfaces may cause serious burns or injuries. If appliance is still hot, use oven mitts to protect your hands.

BBQ MAINTENANCE

Apart from cleaning, your BBQ is a fairly low maintenance appliance. Below are a couple of things worth looking at though. Remember to turn off and disconnect the gas before any maintenance is carried out.

- If your BBQ uses a flexible hose to connect to the gas, check the rubber O-ring on the regulator end of the hose assembly at least once a year. If it appears worn or cracked, have it replaced.
- We recommend having your BBQ checked by an authorized service agent every 5 years. This is to ensure there are no leaks and that all components are still functioning correctly.
- If you use a portable gas cylinder, you will need to have the cylinder serviced or replaced every ten years. The date of the last service should be stamped on the neck of the bottle.
- Please refer to AS5601/AG601 for further information on pipe sizing.
- Keep the outdoor BBQ area clear and free from combustible materials, gasoline, and other flammable vapours or liquids.
- Make sure there is no obstruction surrounding the BBQ, which may block the flow of combustion and ventilation air.
- To maintain the surface of your hotplate, it is recommended to keep the hotplate plate oiled at all times and covered when not in use. A BBQ cover is also recommended to protect your BBQ from all weather conditions.

IMPORTANT INFORMATION

- This product is for outdoor use only.
- Do not use indoors.
- Do not use below ground level.
- Do not store gas cylinders below ground level.
- LP gas is heavier than air so if a leak occurs the gas will collect at a low level and could ignite in the presence of a flame or spark.
- Do not store or use gas cylinders on their side as this could allow liquid gas into the supply pipes with serious consequences.
- Leak test your BBQ before each use. Leak test the hose connections each time you reconnect the gas cylinder.
- Always turn off the gas at the cylinder when not in use.
- Inspect the hose before each use. If there is evidence of excessive abrasion or wear, or the hose is cut it must be replaced prior to the BBQ being put into operation.
- Only use hose supplied from the manufacturer.

You must have the correct gas cylinder and gas hose for BBQ to operate safely and efficiently. Use of an incorrect gas cylinder or gas hose is dangerous and will void the warranty on this product.

BURNER MAINTENANCE

You should check the burner periodically for any sort of blockage. To do this, remove and inspect the burner. If any of the holes are clogged, gently tap the burner onto a hard surface to remove residue. Use a wire brush to unclog the holes. Once this is done, lightly coat the burner with oil to help protect them from rust.

To reduce the chance of “FLASH-BACK”, the procedure below should be followed at least once a month in late summer or early fall when spiders are most active or when your BBQ has not been used for a period of time.

1. Turn the gas cylinder valve (clockwise) to the full OFF position.
2. Detach the gas hose from the gas cylinder.
3. Remove burner from the bottom of the BBQ. Use a screwdriver.
4. Carefully lift burner up and away from the BBQ.
5. Refer to below and perform one of these three cleaning methods.

Bend a stiff wire, (a lightweight coat hanger works well) into a small hook as shown below. Run the hook through the burner tube and inside the burner several times to remove any debris.

Use a bottle brush with a flexible handle. Run the brush through the burner tube and inside the burner several times, removing any debris.

Use an air hose to force air through the burner tube. The forced air should pass debris or obstructions through the burner and out the ports.







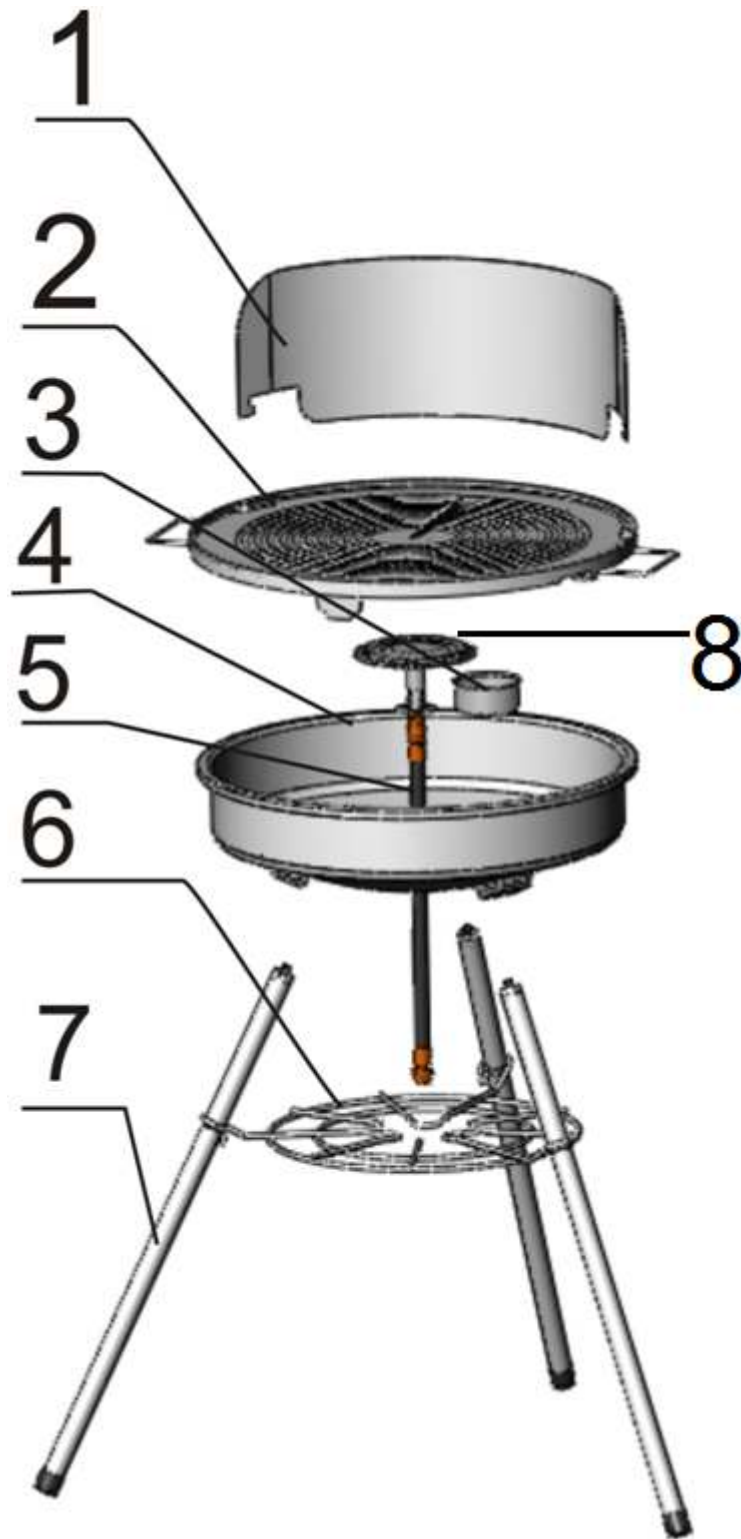

1. Regardless of which burner cleaning procedure you use, we recommend you also complete the following steps to help prolong burner life.
2. Use a wire brush to clean the entire outer surface of each burner until free of food residue or dirt
3. Clean clogged ports with wire, such as an open paper clip.

Inspect burner after installation and check to ensure it is securely tightened to the gas hose.

EXPLODED VIEW



CARTON CONTENTS AND PARTS CODE

Parts Number	Description	Parts Code	Illustration	Quantity
1	Windshield	A16001		1
2	Cooking Plate	A16002		1
3	Oil Cup	A16003		1
4	BBQ Body	A16004		1
5	Gas Hose	A16005		1
6	Wire Shelf	A16006		1
7	Leg	A16007		3
8	Gas Burner	A16008		1
9	Bolt M4	A16009		3

ASSEMBLY INSTRUCTIONS

Remove all contents from packaging, and make sure all the parts are present before attempting to assemble! Tighten all bolt connections by hand first. When the BBQ is fully assembled, retighten using a wrench.

Step 1

Install Gas Burner(Part 8) onto BBQ Body(Part 4) and secure using Bolt M4(Part 9). Connect Gas Hose(Part 5) to the Gas Burner(Part 8) connection located under the BBQ Body(Part 4) and tighten firmly. Ensure gas connection to gas burner is secured tightly. Refer to illustration below.



Step 2

Install Legs(Part 7) to the BBQ Body(Part 4) as per illustration below. Attach Wire Shelf(Part 6) to the Legs(Part 7) as per illustration below.



Step 3

Place Oil Cup(Part 3) and Cooking Plate(Part 2) onto the BBQ Body(Part 4) as per illustration below.

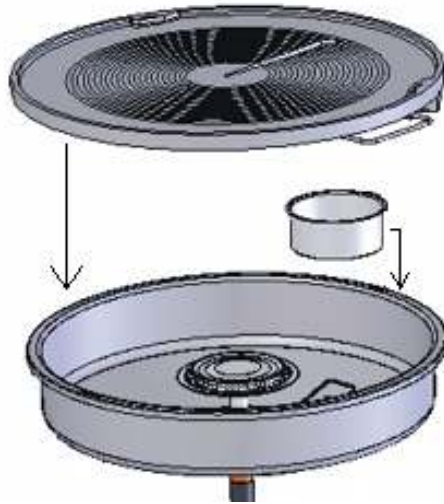

Step 4

Secure Windshield(Part 1) onto the Cooking Plate(Part 2) as per illustration below.

Ensure the Wire Shelf(Part 6) is secured onto the Legs(Part 7) via the concave groove on the Legs(Part 7). Refer to illustration below.



Fully-Assembled



jumbuck

SPECIFICATION

BRAND NAMES: JUMBUCK

APPLIANCE: Single Burner Round BBQ

**CERTIFICATE
HOLDER:** Genesis Australia Corporation Pty Ltd
2/26 Industry Street Malaga 6090 Western
Australia
Phone: 61-8-9248 9822
Fax: 61-8-92488986

MODELS: A160 three legged round BBQ

FEATURES: Steel windshield with powder coated; 45cm cast iron hotplate; stainless steel burner; chrome plated legs

BURNER: See drawing pages

GAS VALVES: N/A

**REGULATOR/HOSE
ASSEMBLY:** GENESIS HOSE 8MM Class "C" 2.6Mpa

PIEZO IGNITOR: N/A

BURNER	NGC	TEST POINT PRESSURE	INJECTOR
Single Burner	10.9MJ	Vapour Pressure	0.2mm



WARRANTY

Thank you for purchasing one of our quality Jumbuck BBQs.

YOUR JUMBUCK BBQ IS COVERED AGAINST DEFECTS FOR A PERIOD OF 12 MONTHS FOR PARTS AND LABOUR, REPAIR OR REPLACEMENT THIS WARRANTY EXCLUDES SURFACE RUST AND DAMAGE CAUSE BY ABUSE OR NEGLECT

CONDITIONS OF THE WARRANTY

- The appliance must be operated and maintained in accordance with the instructions supplied in the operating manual.
- Any repair does not extend the warranty period.
- Any parts other than original Jumbuck parts will void this warranty.

INSTALLATION CONDITIONS

- All installations must conform to the applicable Gas, Electrical and Building standards as laid down by the local codes for state or region.
- If the appliance is changed to natural gas (if applicable), it must be converted and installed by a licensed gas fitter.

FOR WARRANTY CLAIMS

The warranty for Australia is given by :

Genesis Australia Corporation Pty Ltd
2/26 Industry St
Malaga
Western Australia 6090
AUSTRALIA
(08) 9248 9822

service@genesiscorp.com.au

Proof of purchase must be presented.

The warranty for New Zealand is given by :

Bunnings NZ Limited
PO Box 14436,
Panmure, Auckland, 1471
NEW ZEALAND
(09) 978 2200

marketing@bunnings.co.nz

Proof of purchase must be presented.

Any claims under this warranty must be made within 12 months of the date of purchase of the product.



WARRANTY

For Australian Customers

To make a claim under the warranty, please contact Genesis Australia at service@genesiscorp.com.au or return the product (with proof of purchase) to any Bunnings store. Visit www.bunnings.com.au for store locations.

Genesis Australia bears reasonable, direct expenses of claiming under the warranty. You may submit details and proof to us for consideration.

The warranty covers manufacturer defects in materials, workmanship and finish under normal use.

This warranty is provided in addition to other rights and remedies you may have under law: our goods come with guarantees which cannot be excluded under the Australian Consumer Law. You are entitled to replacement or refund for a major failure and to have the goods repaired or replaced if the goods fail to be of acceptable quality and the failure does not amount to a major failure.

The warranty excludes damage resulting from product misuse or product neglect. The warranty covers domestic use only and does not apply to commercial applications.

For New Zealand Customer

Any claim under this warranty must be made within 12 months of the date of purchase of the product. To make a claim under the warranty, take the product (with proof of purchase) to any Bunnings store. Visit www.bunnings.co.nz for store locations.

Bunnings NZ Ltd bears reasonable, direct, expenses of claiming under the warranty. You may submit details and proof to our store for consideration.

The warranty covers manufacturer defects in materials, workmanship and finish under normal use.

This warranty is provided in addition to other rights and remedies you may have under law: our goods come with guarantees which cannot be excluded under the Consumer Guarantees Act 1993 (NZ). You are entitled to replacement or refund for a major failure and to compensation for other reasonably foreseeable loss or damage. You are also entitled to have the goods repaired or replaced if the goods fail to be of acceptable quality and the failure does not amount to a major failure.

Goods presented for repair may be replaced by refurbished goods of the same type rather than being repaired. Refurbished parts may be used to repair the goods.

The warranty excludes damage resulting from product misuse or product neglect. The warranty covers domestic use only and does not apply to commercial applications.



WARRANTY

WHAT IS NOT COVERED IN THE WARRANTY

- Removal or re-installation costs. This warranty does not cover costs for transit, nor in home service
- Liability will only be accepted for loss or damage during transit if at the time the product was being transported by Bunnings or a Bunnings approved contractor.
- Lack of maintenance, abuse, neglect, misuse, accidental or improper installation of this appliances
- Scratches, dents, corrosion or discoloration caused by heat, abrasive chemicals cleaners
- Corrosions or damage caused by exposure to elements such as insects, weather, hail or grease and fat fires
- Rusting of hotplate and burner
- Cleaning and wear and tear, service calls of this nature are chargeable
- Commercial use of this product
- Unauthorized repairs or modification during warranty period

RECORD THE FOLLOWING INFORMATION

Attached the copy of the purchase receipt here

Date of Purchase.....

Purchased From.....

Location.....

Model Name and Number.....

Serial Number.....

Receipt Number.....

Note: The serial number is located either on the outside of the packing carton or outside or inside the appliance

FOR TECHNICAL ASSISTANCE

For Australia customers if you experience any technical issues with your JUMBUCK BBQ, in the first instance review the instructions manual or contact the warranty service agent

For New Zealand customers if you experience any technical issues with your JUMBUCK BBQ, in the first instance review the instructions manual or contact your local Bunnings warehouse

FOR SPARE PARTS

Call your local Bunnings warehouse and ask them to order a part for you. You should provide the following information:

Model of BBQ

.....

Year of Purchase

.....

Name of warranty service company

.....

Part that requires replacement (refer to the parts list in the instructions manual)

.....