

# Cabinet Fixing Instructions

(SUP891)

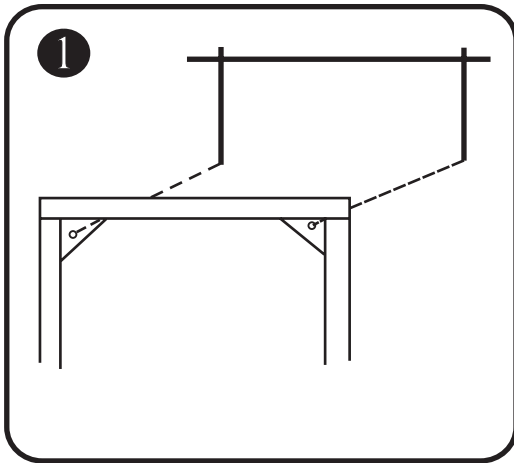

- Ensure there are no hidden service pipes and cables where you intend to drill.
- If drilling into ceramic tiles, use a drill bit specifically for ceramic tiles.
- Where possible, drill holes in the grout between the ceramic tiles.
- Should the doors need adjustment, slightly unscrew or tighten the two adjustment screws in the centre of the hinge plate.

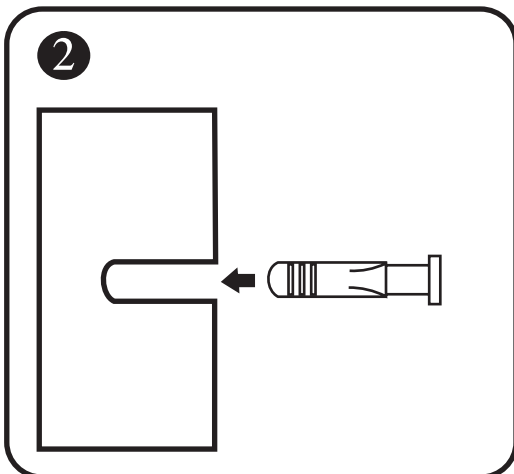

- 1 Hold the cabinet into position, ensuring that it is level. Mark the fixing positions on the wall through the fixing holes in the cabinet.
- 2 Drill 4 holes of diameter 6.5mm x 42 mm deep and insert the 4 plastic wall plugs (Dia. 2).
- 3 Position the cabinet over the drilled holes and fit the screws into the plastic plugs through the cabinet. (Dia. 3). After mounting the cabinet, fit the shelf supports to the holes on each side of cabinet and place the shelves onto the shelf supports.

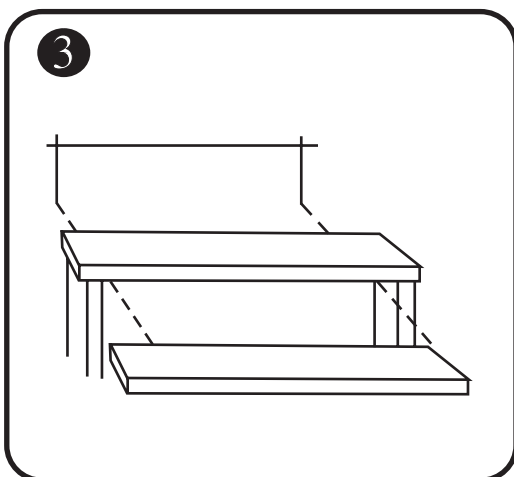

## *Included are:*

Description	QTY
Phillips screw 50mm (L)	4 pcs
Plastic wall plug 40mm (L)	4 pcs
White plastic insert for shelf adjustment	12 pcs

The screws and wall plugs supplied are only suitable for use in solid walls

## *Tools required:*

Masonry Drill Bit 6.5mm  
Posi Screwdriver  
Spirit Level