

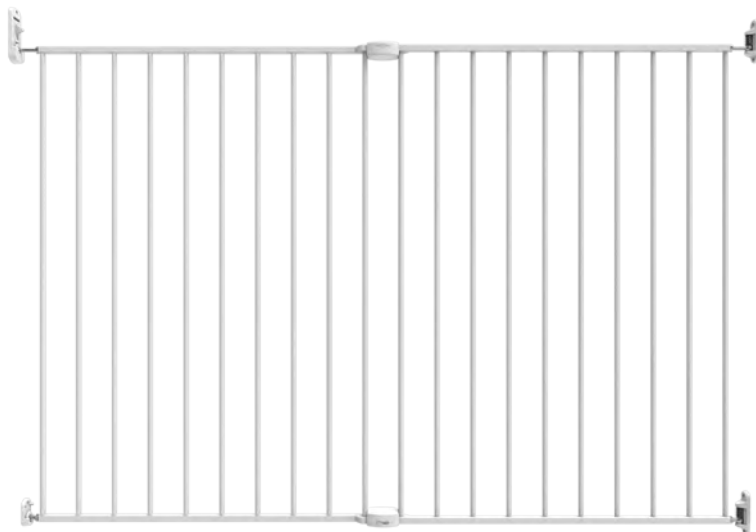

# Superior Swing Gate

Fits opening size 62cm to 102cm



**IMPORTANT! READ AND FOLLOW  
THESE INSTRUCTIONS CAREFULLY  
AND KEEP FOR FUTURE REFERENCE**

This product complies with EN1930:2011 Standard.

AFTER SALES SUPPORT

 [info@childsafetyhelp.com](mailto:info@childsafetyhelp.com)

PRODUCT CODE: 747 10/16

# Parts List

- A. 1x Hinge side template
- B. 1x Locking side template
- C. 2x Hinge Bottom
- D. 2x Spring
- E. 2x Spring Cover
- F. 2x Hinge cap
- G. 2x Hinge Bolt
- H. 8x Wood Screws
- I. 1x Top Catch Bracket
- J. 1x Bottom Catch Bracket
- K. 2x Adjustable Catch Bolt
- L. 2x Stop Pin
- M. 1x Wrench
- N. 2x Top Gate Connector
- O. 2x Bottom Gate Connector

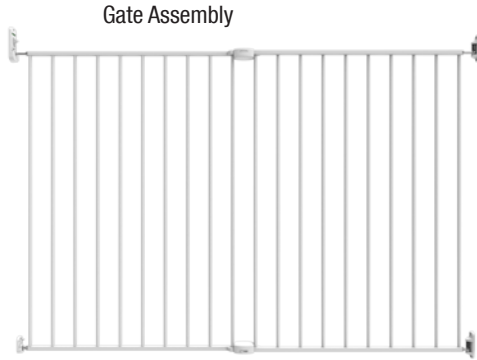

Hinge Assembly

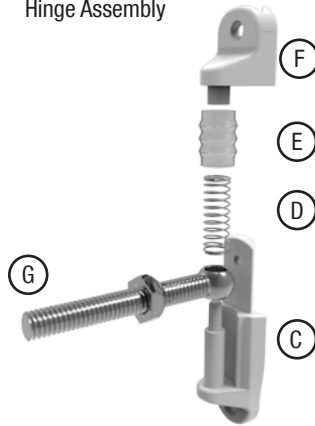

# Safety Information

---

## **WARNING**

- WARNING** - To prevent serious injury or death, securely install gate or enclosure and use according to manufacturer's instructions.
- WARNING** - Never leave child unattended when using this product.
- WARNING** - Incorrect installation can be dangerous.
- WARNING** - Do not use the safety barrier if any components are damaged or missing.
- WARNING** - The safety barrier must not be fitted across windows.
- WARNING** - Never use with a child able to climb over or dislodge/open the gate or enclosure.
- WARNING** - Danger to older children if climbing over the product.
- WARNING** - Never install this product on glass doors. Install this product against reliable doors or walls.
- WARNING** - If the safety barrier is used at the top of the stairs, it should not be positioned below the top level.
- WARNING** - If the safety barrier is used at the bottom of the stairs, it should be positioned at the front of the lowest tread possible.

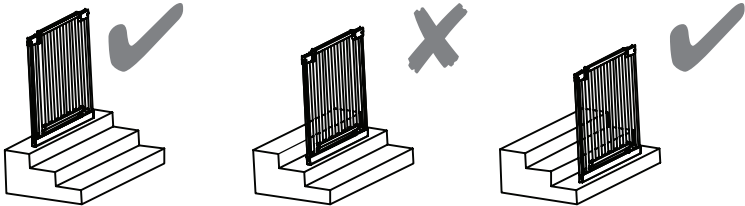

- WARNING** - Do not put any goods which can be grabbed by children or pets near this product to prevent injury.
- WARNING** - Before using this product, carefully inspect for any loose parts and whether any parts needs to be tightened.
- WARNING** - Make sure the product to be installed is horizontal and flat on the floor.
- WARNING** - This product is intended for use with children from 6 to 24 months or small to medium pets.
- WARNING** - Regularly check that the safety barrier is properly installed and secure.
- WARNING** - Any additional or replacement parts should be obtained from after sales support
- WARNING** - Barrier must be fitted between rigid surfaces such as plaster board, timber or hardwall.
- WARNING** - Always check that the safety barrier is correctly closed.
- WARNING** - Use only with the locking / latching mechanism securely engaged.
- WARNING** - This safety barrier is for domestic use only.
- WARNING** - This safety barrier has a manual closing system.

# Installation

---

**Important:** Gate must be installed in a structurally sound opening. Ensure mounting surface (wall, door frame, stairposts, ect.) is strong, rigid and has an even surface.

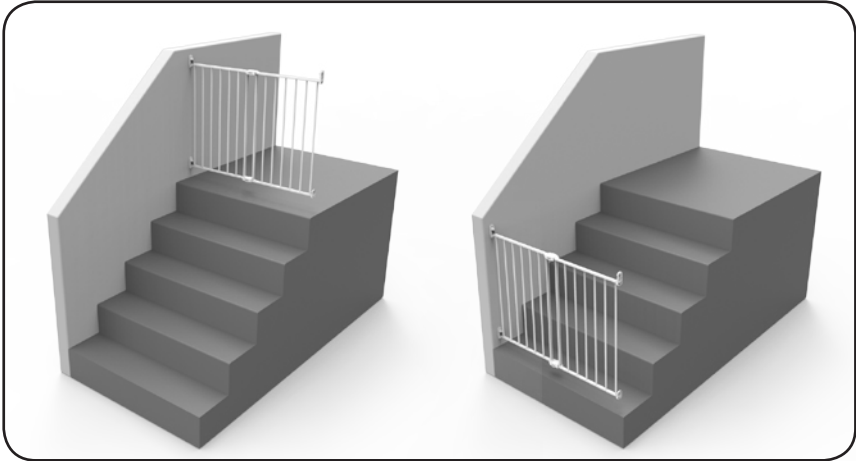

If using gate on a stairway, it must be placed either on the top step or on the lowest step at the bottom.

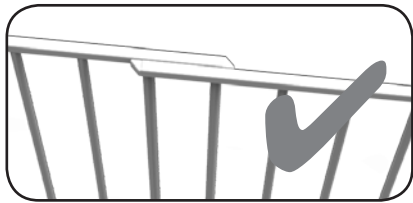
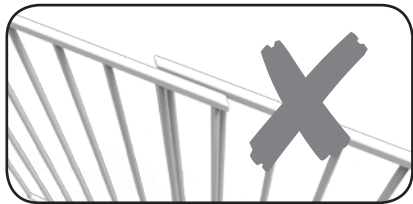

1. Adjust sections until gate is approximately the correct width. Sections should fit without any distance between rails or bars.

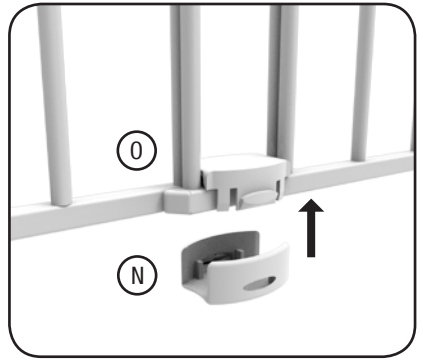
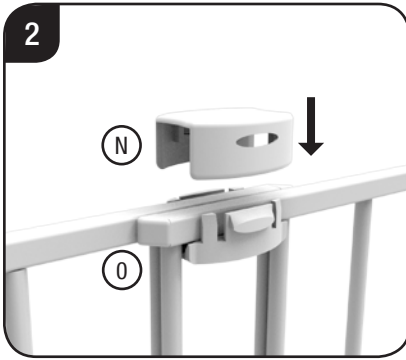

2. Lock gate sections in place together using top (N) and bottom (O) gate connector.

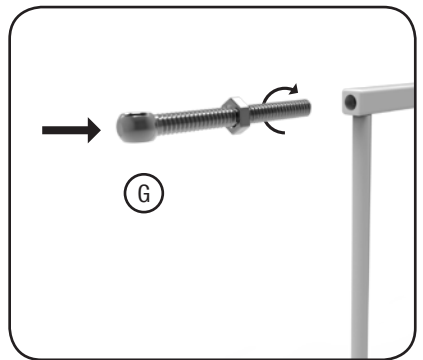
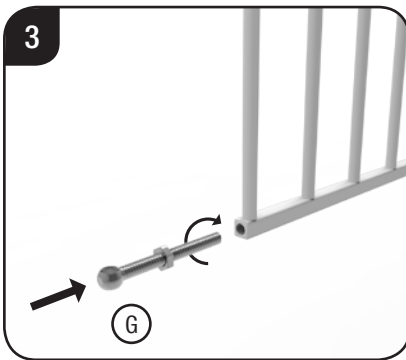

3. Screw hinge bolts (G) into top and bottom rail of one gate section.  
Extend bolts equally.

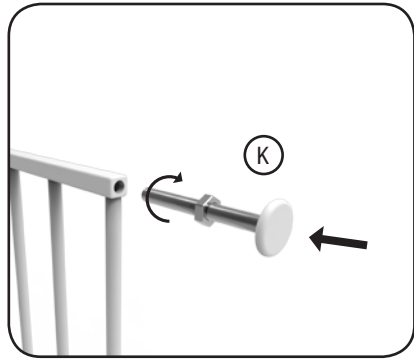
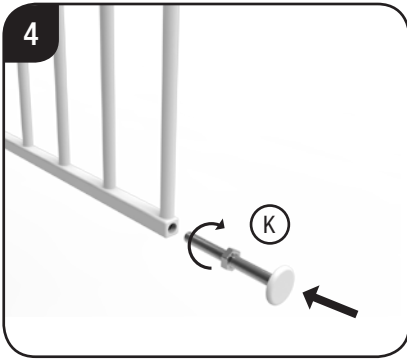

4. Screw adjustable catch bolts (K) into top and bottom rails of second gate section. Extend bolts equally. Final bolts adjustments will be made later.

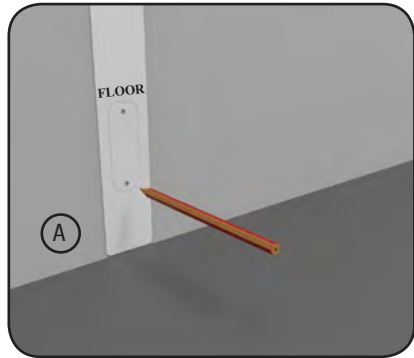
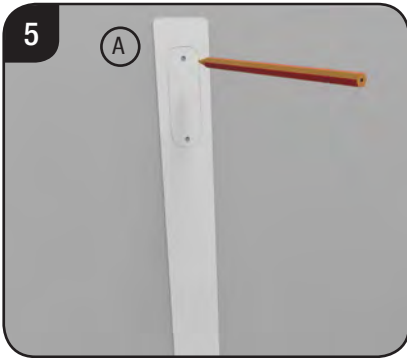

## 5. Hinge Side Mounting

**Screws provided are for mounting directly into wood. If mounting into brick, drywall or other surfaces use appropriate hardware, note that drilling a pilot hole may be necessary.** Hold template (A) vertically and completely outstretched against mounting surface with the end marked "FLOOR" even with the floor. Mark screw hole positions. Remove the template.

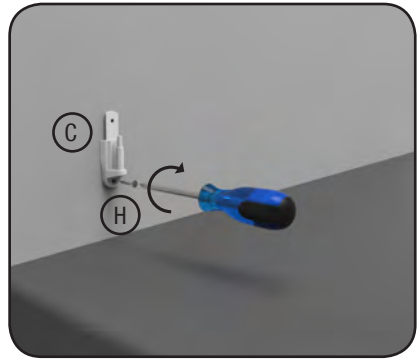
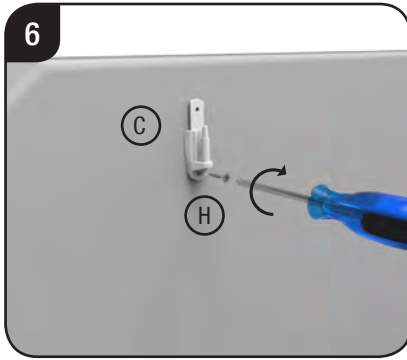

6. Using screws (H), mount upper and lower hinge bottoms (C) (with posts pointing up) in screw hole positions marked in previous step.

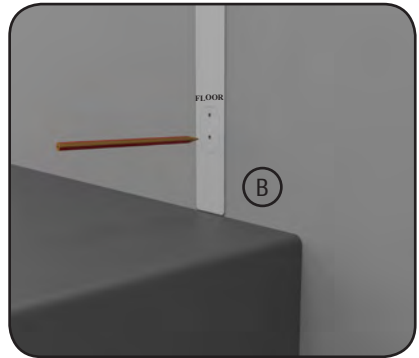
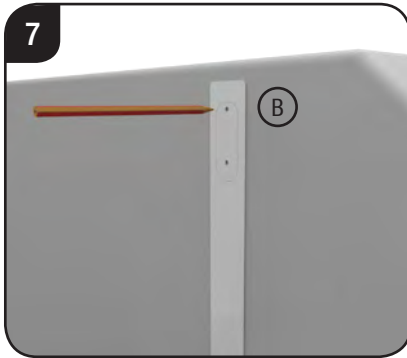

## 7. Locking Side Mounting

**Screws provided are for mounting directly into wood. If mounting into brick, drywall or other surfaces, use appropriate hardware, note that drilling a pilot hole may be necessary.** Hold template (B) vertically and completely outstretched against mounting surface with the end marked "FLOOR" even with floor. Mark screw hole positions. Remove the template.

# Superior Swing Gate User Guide

---

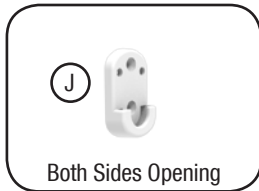
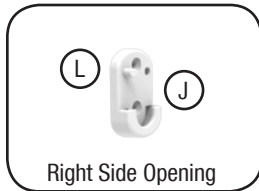

8. Determine which direction the gate should be open. **For the top of stairways, gate should never open out over stairs.** Insert stop pin (L) from behind in holes of bottom catch bracket (J) opposite desired opening direction.  
**Important: The gate cannot open to the stop pin side.**

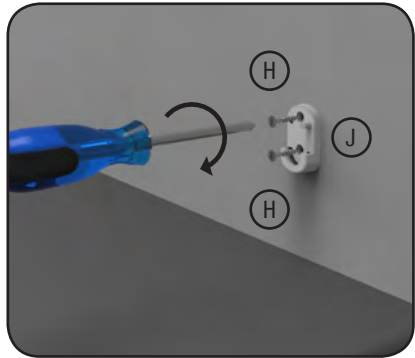
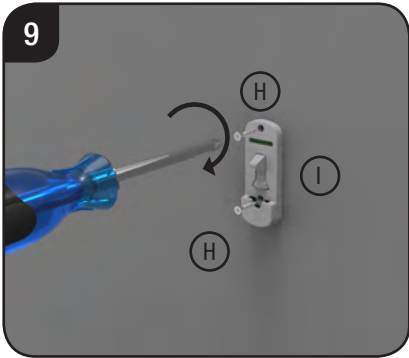

9. Use longer screws for mounting into studs behind drywall. Using 2 screws (H) mount top catch bracket (I) and bottom catch bracket (J) in screw hole positions marked in previous step.



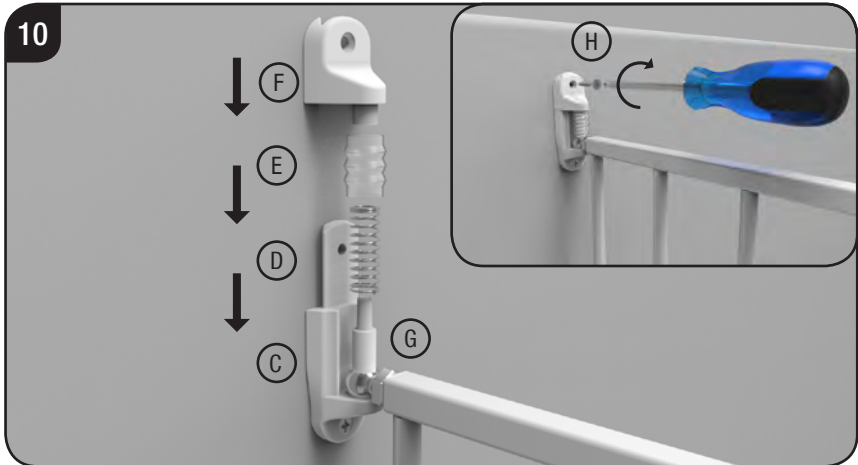

10. Center gate in opening. Adjust upper and lower hinge bolts (G) so post fits into bolt eyelet. Place spring (D) and spring cover (E) on upper and lower hinge posts. Place hinge cap (F) on hinge and push down until it locks in position. Screw in place.

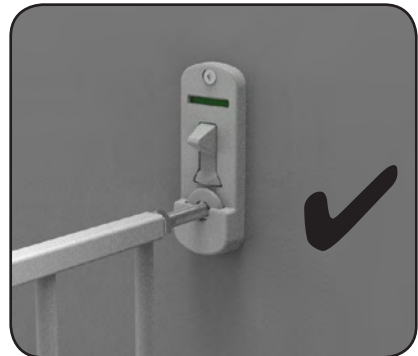

11. Adjust catch bolts (K) until they fit securely into both catch brackets. Top bolt must click under locking latch when in the closed position.

NOTE: If adjusting the bolts does not achieve the correct length, it may be necessary to lift gate off hinges and readjust the sections (see step 3).

Check that gate can be smoothly opened and closed.

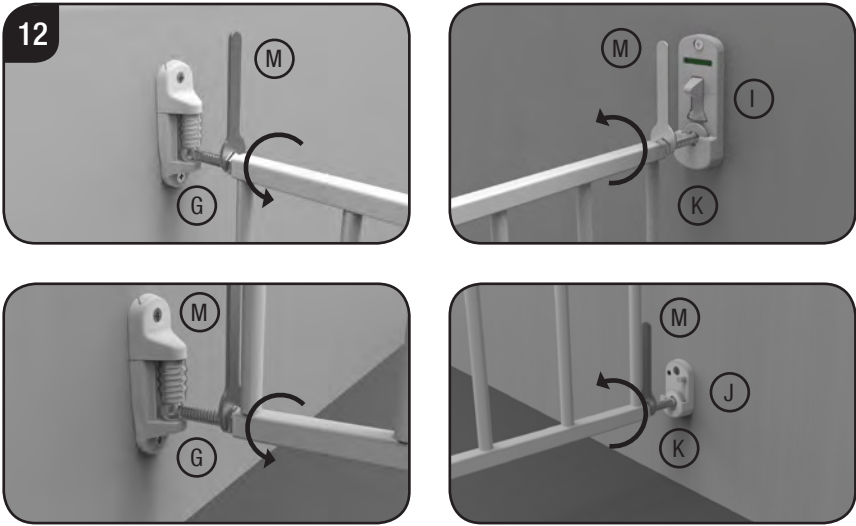

12. When satisfied with gate width, using a Phillips head screw driver, tighten all screws. With wrench (M), tighten all 4 lock nuts toward the gate.

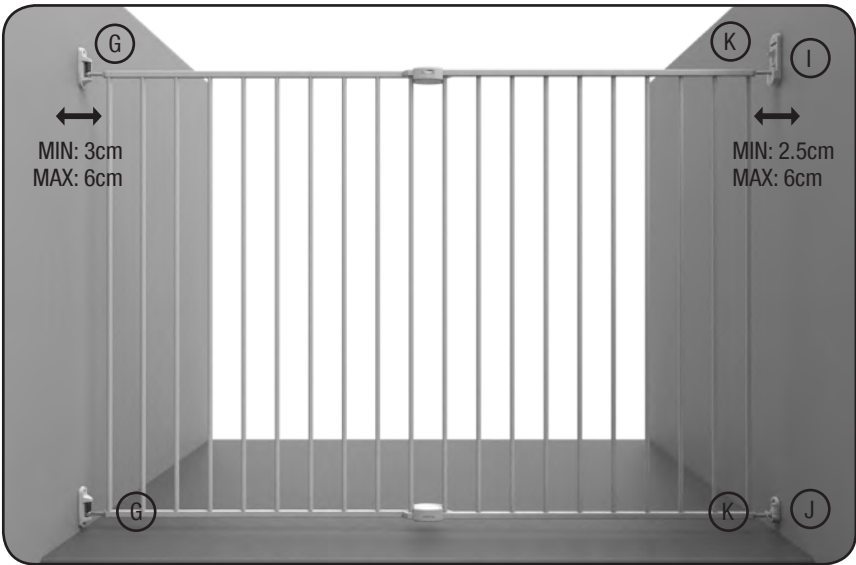

## Operation

---



To open gate, press down on top catch bracket with thumb and lift gate out of upper and lower brackets.

To lock gate, top adjustable catch bolt must rest in top catch bracket and bottom adjustable catch bolt must rest in bottom catch bracket.

**NOTE: GATE SHOULD ALWAYS BE IN THE LOCKED POSITION. IF GATE IS OPEN AND EXCESSIVE PRESSURE IS APPLIED, (SUCH AS STANDING OR SWING ON GATE) STRUCTURAL DAMAGE MAY OCCUR.**

## Cleaning Instructions

---

Use a soft damp cloth simply wipe gate, dry after cleaning. Do not use chemical or abrasive cleaners.

## Warranty Certificate

---

Congratulations! You have made an excellent choice of this quality product. Our commitment to quality also includes our service. Should you, contrary to expectations, experience defects due to manufacturing faults, we will provide you with a warranty against defects as follows:

### Warranty

The product is guaranteed to be free from defects in workmanship and parts for a period of 12 months from the date of purchase. Defects that occur within this warranty period, under normal use and care, will be repaired, replaced or refunded at our discretion. The benefits conferred by this warranty are in addition to all rights and remedies in respect of the product that the consumer has under the Competition and Consumer Act 2010 and similar state and territory laws.

Our goods come with guarantees that cannot be excluded under the Australian Consumer Law. You are entitled to a replacement or refund for a major failure and for compensation for any other reasonably foreseeable loss or damage. You are also entitled to have the goods repaired or replaced if the goods fail to be of acceptable quality and the failure does not amount to a major failure.

### Proof of Purchase

This warranty is valid for the original purchase and is not transferable. Please keep your purchase docket, tax invoice or receipt as the best proof of purchase, and as proof of date on which the purchase was made.

### Extent of Warranty

This warranty is limited to defects in workmanship or parts. All defective products or parts will be repaired or replaced. This warranty does not cover consumable items.

### Normal Wear and Tear

This warranty does not cover normal wear and tear to the products or parts.

### Exclusions

This warranty does not cover:

- Any defects caused by an accident, misuse, abuse, improper installation or operation, lack of reasonable care, unauthorised modification, loss of parts, tampering or attempted repair by a person not authorised by the distributor.
- Any product that has not been installed, operated or maintained in accordance with the manufacturer's operating instructions provided with the product.
- Any product that has been used for purposes other than domestic use.

### To Make a Claim

If a defect in the goods appears within 12 months, you are entitled to claim a warranty, please contact or send all warranty claims to:

PERMA Products  
info@childsafetyhelp.com  
1300 467 068

When making a return, please ensure the product is properly packaged so as to ensure that no damage occurs to the product during transit.

Please provide the original or a copy of the proof of purchase. Also please make sure you have included an explanation of the problem.