



MAKE IT EASY
Protector^{AI}

Josh and Jenna show you how
at www.protectoraluminium.com.au



ADJUSTABLE LOUVER EASY SCREEN

INSTALLATION GUIDE

ADJUSTABLE LOUVER SPECIFICATIONS

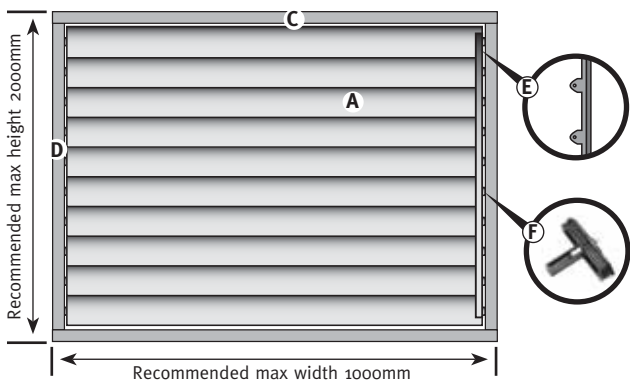

- (PART A)** Louver Blades 76x16x1994mm
- (PART C)** Louver Top/Bottom Rails 55x25x2000mm
(Rails and Blades can be cut to fit the size you require)
- (PART D)** End Rails Adjustable Louver (2 required) 50x25x2000mm
- (PART E)** Adjustable Control Arm 25x10x1892mm
- (PART F)** End Caps Adjustable Louver – packs of 4 (2 per blade)
- Screws** Wafer Head 16mm long – packs of 50
(8 screws per Top/Bottom Rail)

BLADE CALCULATOR

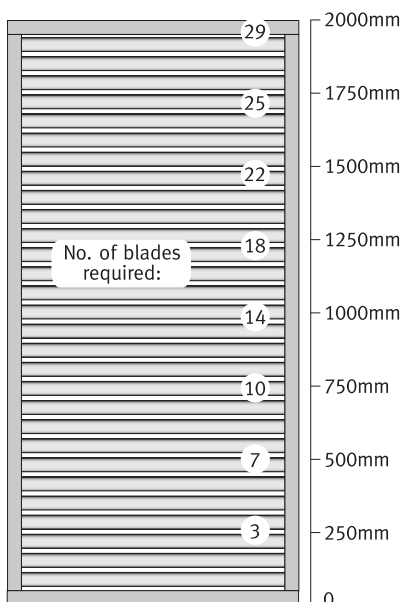

The calculator shows at a glance the number of blades (PART A) required to fit maximum height 2000mm.

NOTE: For each blade you will need 2 Part F End Caps





ADJUSTABLE LOUVER ASSEMBLY SCREEN

Tools Required: Pencil, String-line, Tape Measure, Spirit Level, Drill, Tek Gun/Drill, Angle Grinder/Hacksaw

INSTALL FRAME

1. Cut End Rails (D) 4mm shorter than total height of Screen. Allow minimum 60mm from pivot hole to end of rail for louver blade to function (fig.1).
2. Cut Top/Bottom Capping (C) to total width of Screen.
3. Fix End Rail (D) to side openings. Rail pulls apart for drilling and fixing, so screws are hidden. (fig.2)
4. Clip inner section of End Rail (D) back into fixed portion of rail. (fig.2)
5. To finalise Frame Screw Top/Bottom Capping (C) to End Rails (D). (fig.3)

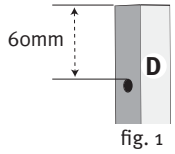

fig. 1

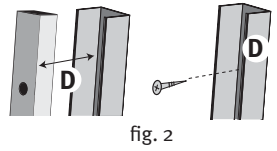

fig. 2

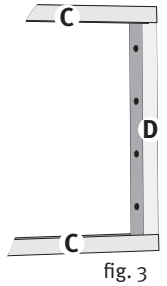

fig. 3

LOUVER BLADES

1. Cut Blades (A) 15mm shorter than the gap between the End Rails.
2. Complete Blade assembly by inserting End Caps (F) into each end of Blade (A) (fig.4)
3. Insert one end of assembled Blade (A) into one End Rail (D) (fig.5), insert other end by compressing spring loaded pivot as you slide it into place (fig.6). Repeat until all blades are fitted.
4. Cut the Control Arm (E) to length and attach to left or right end of Blades using the small screws provided into the pre-drilled holes in the End Caps (fig.7). Adjust the screw tension to control the movement of the Blades.

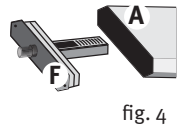

fig. 4

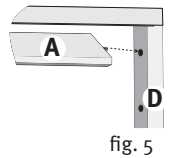

fig. 5

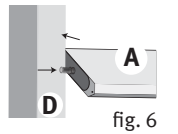

fig. 6

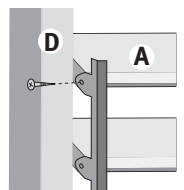

fig. 7

CUSTOM SERVICE AVAILABLE



If you can dream it, we can make it! Any size, any colour. Visit Bunnings Warehouse Special Orders for details.



9 338797 020835