

18V LITHIUM ION

CORDLESS BLOWER KIT

INSTRUCTION MANUAL

SPECIFICATIONS

Voltage:	18V
Battery:	4.0Ah Li-ion
Charge Time:	80 min
No Load Speed:	12,000/min
Max. Air Speed:	210km/hr
Weight:	2.0kg

ozito.com.au

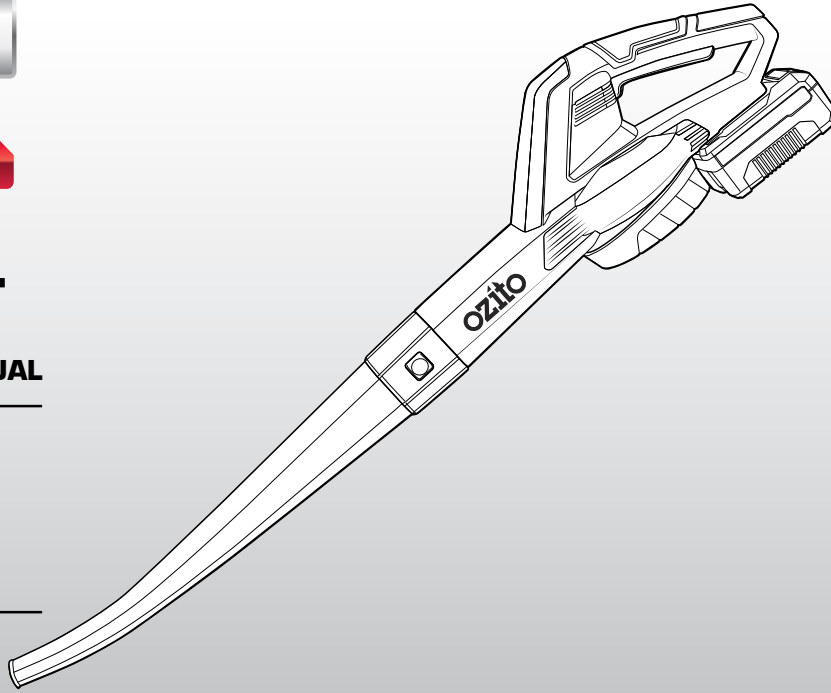

WHAT'S IN THE BOX

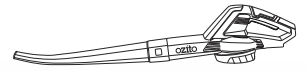

Cordless Blower

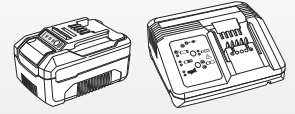

4.0Ah Battery & Fast Charger

5 YEAR
REPLACEMENT WARRANTY

PXCBLK-418

WARRANTY

IN ORDER TO MAKE A CLAIM UNDER THIS WARRANTY YOU MUST RETURN THE PRODUCT TO YOUR NEAREST BUNNINGS WAREHOUSE WITH YOUR BUNNINGS REGISTER RECEIPT. PRIOR TO RETURNING YOUR PRODUCT FOR WARRANTY PLEASE TELEPHONE OUR CUSTOMER SERVICE HELPLINE:

Australia 1800 069 486

New Zealand 0508 069 486

TO ENSURE A SPEEDY RESPONSE PLEASE HAVE THE MODEL NUMBER AND DATE OF PURCHASE AVAILABLE. A CUSTOMER SERVICE REPRESENTATIVE WILL TAKE YOUR CALL AND ANSWER ANY QUESTIONS YOU MAY HAVE RELATING TO THE WARRANTY POLICY OR PROCEDURE.

WARNING

The following actions will result in the warranty being void.

- If the tool has been operated on a supply voltage other than that specified on the tool.
- If the tool shows signs of damage or defects caused by or resulting from abuse, accidents or alterations.
- Failure to perform maintenance as set out within the instruction manual.
- If the tool is disassembled or tampered with in any way.

The benefits provided under this warranty are in addition to other rights and remedies which are available to you at law.

Our goods come with guarantees that cannot be excluded at law. You are entitled to a replacement or refund for a major failure and for compensation for any other reasonably foreseeable loss or damage. You are also entitled to have the goods repaired or replaced if the goods fail to be of acceptable quality and the failure does not amount to a major failure.

Generally you will be responsible for all costs associated with a claim under this warranty, however, where you have suffered any additional direct loss as a result of a defective product you may be able to claim such expenses by contacting our customer service helpline above.

5 YEAR REPLACEMENT WARRANTY

Your Product is guaranteed for a period of 60 months from the original date of purchase and is intended for DIY (Do It Yourself) use only. If a product is defective it will be replaced in accordance with the terms of this warranty. **Lithium Ion batteries and chargers are covered by a 36 month warranty.** Warranty excludes consumable parts, for example: blower tube.

KNOW YOUR PRODUCT

CORDLESS BLOWER

1. Blow Tube
2. Blow Tube Release Tab
3. Sure Grip Handle
4. Trigger Switch
5. Battery Seating

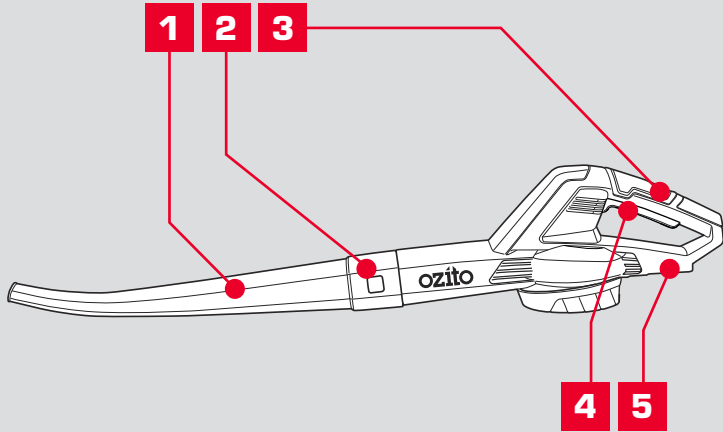

ACCESSORIES

6. Battery Release Tab
7. Battery Charge LED's
8. Battery Charge Indicator Button
9. Charger LED's
10. Charger

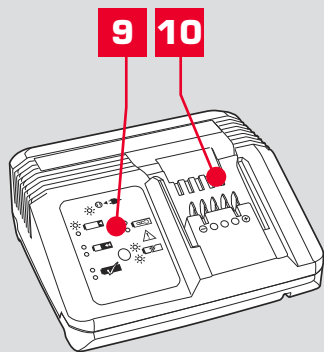
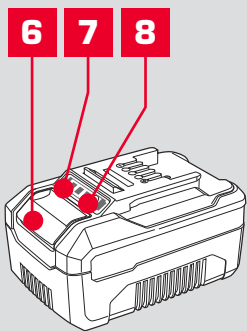

ONLINE MANUAL

Scan this QR Code with your mobile device to take you to the online manual.

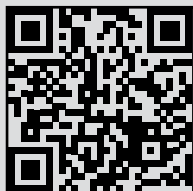

SETUP & PREPARATION

1. ASSEMBLY

WARNING! ENSURE THE TOOL IS SWITCHED OFF AND BATTERY DISCONNECTED BEFORE PERFORMING ANY OF THE FOLLOWING TASKS.

Fitting the Blower Tube

1. Align the blower tube with the outlet of the blower.

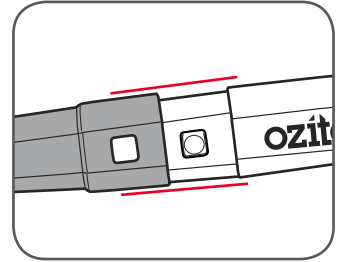

2. Push the blower tube onto the blower until it clicks into place.

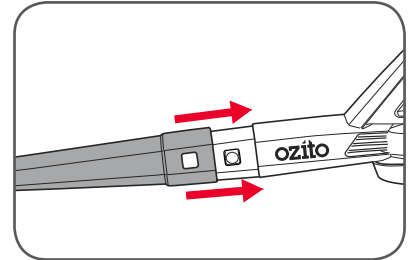

3. To remove the blower tube, press the blower tube release tab while pulling the tube away from the housing.

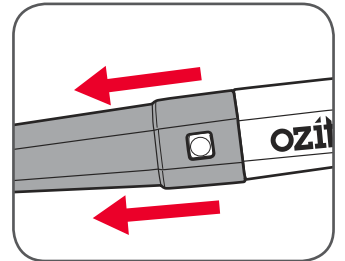

5 YEAR
REPLACEMENT WARRANTY

2. BATTERY & CHARGING



CAUTION: THE CHARGER FOR THIS PRODUCT SHOULD BE PROTECTED BY A RESIDUAL CURRENT DEVICE (RATED AT 30MA OR LESS).

Charging your lithium ion battery

The tools battery has been shipped in a low charge condition, and requires charging prior to use. Allow several cycles of charging and discharging (through use of the tool) for the battery to reach its optimum performance / runtime.

Charging your lithium ion battery - Fast Charger

1. Connect the charger into a mains power outlet.

2. The charger LED will flash green showing power is being supplied to the charger.

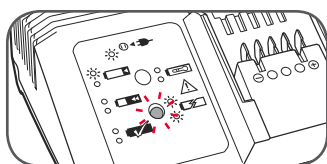

3. With the charger sitting on a flat surface, align the raised ribs on the battery with the recess in the charger and slide onto the charger ensuring a firm connection.

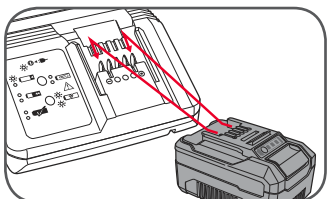

4. The charger LED will illuminate red signifying that the battery is charging.

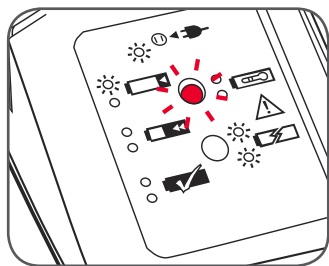

5. The charger LED will illuminate green once the battery is fully charged.

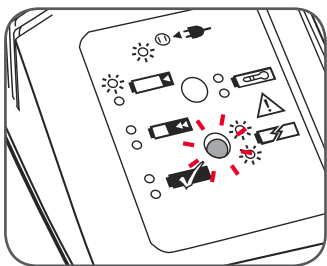

Charger LED Indicator

LED Indicator	Situation
GREEN (Flashing)	Stand By (no battery pack is inserted)
RED (Flashing)	Battery is charging (low charge)
RED (Illuminated)	Battery is charging (mid charge)
GREEN (Illuminated)	Battery is fully charged
BOTH (Illuminated)	Battery pack is too hot or too cold (charging will begin automatically when battery reaches correct charging temperature).
BOTH (Flashing)	Defective battery. Never charge a defective battery pack! Remove battery pack from charger.

Battery Charge Indicator

The purchased battery is equipped with a battery charge indicator to show the state of the battery charge.

Press the charge indicator button and look to see which LED lights.

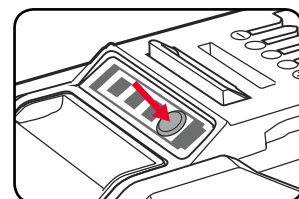

Battery requires immediate charging

Low state of charge, requires charging soon.

Mid state of charge

Full state of charge.

Note: The battery needs to be removed from the tool to check the state of charge.

Battery protection system

The tool is equipped with the battery protection system, which helps to ensure a long service life.

The output power automatically cuts off during operation when the tool and/or battery are placed under the following situations:

- **When the tool is overloaded:**

If this occurs, release the trigger switch and remove causes of overload, then pull the switch trigger again to restart.

- **When the remaining battery capacity becomes low:**

Recharge the battery pack.

Note: The battery protection system does not in any way damage the tool.

Note: The indicated capacity may be lower than the actual level during use or immediately after using the tool.

OPERATION

3. INSERTING & REMOVING THE BATTERY

Inserting the Battery into the Blower

1. Align the ribs of the battery with the recess in below the handle.

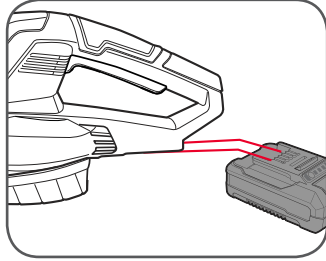

2. Slide the battery in so that it clicks into place.

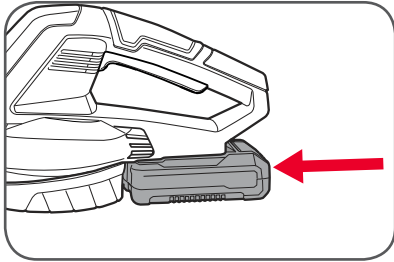

Removing the Battery from the Blower

1. Press and hold the battery release tab to release the battery.

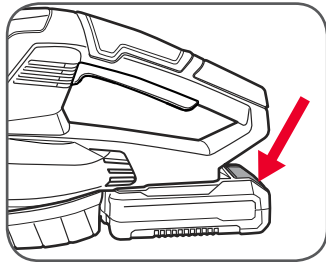

2. Slide the battery out.

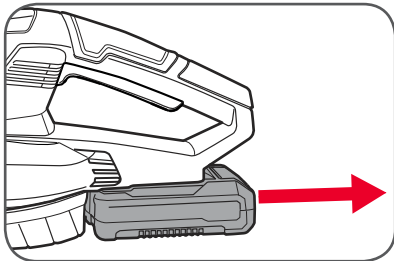

WARNING! DO NOT USE ANY ATTACHMENTS OR ACCESSORIES NOT RECOMMENDED BY THE MANUFACTURER OF THIS PRODUCT, AS IT CAN RESULT IN SERIOUS PERSONAL INJURY.

4. CONTROLS & OPERATION



WARNING! DO NOT USE THE BLOWER WITH ANY TYPE OF ACCESSORY OR ATTACHMENT. SUCH USAGE MIGHT BE HAZARDOUS.

Switching On and Off

1. To start the blower squeeze the on/off switch.
2. To stop the blower release the on/off switch.

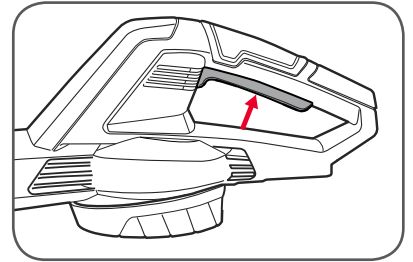

WARNING! DO NOT PUT PART OF YOUR BODY SUCH AS HANDS AND FINGERS IN THE VACUUM OPENING OR EXHAUST OPENING.

Blowing

The blower is ideal for blowing leaves, grass clippings and other debris.

Hold the blower firmly, squeeze the on/off switch, point the jet of air in front of you and move forward slowly. Move the blower from side to side, with the tube several inches above the ground.

Be careful where you point the jet of air as it can move heavy material and cause injury or damage to bystanders.

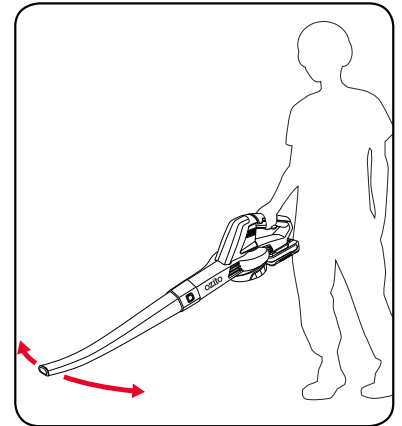

Note: Be aware of other people and animals in the area where you are to be operating the blower.

Note: Avoid collisions with hard objects which could damage your machine.



WARNING! DO NOT SWITCH THE BLOWER ON IN ENCLOSED OR POORLY VENTILATED SPACES OR IN THE PRESENCE OF FLAMMABLE AND/OR EXPLOSIVE LIQUIDS, GASES AND POWDERS.

MAINTENANCE



WARNING! ALWAYS ENSURE THE TOOL HAS COMPLETELY STOPPED AND THE BATTERY IS REMOVED PRIOR TO ANY MAINTENANCE.

- Keep air intake clean and air vents free of debris to avoid overheating the motor.
- Do not use cleaning agents to clean the plastic parts of the tool. A mild detergent on a damp cloth is recommended. Water must never come into contact with the tool.
- If the blower vibrates abnormally, stop motor immediately. Abnormal vibration usually indicates a mechanical problem continued operation could lead to injury or damage.
- No lubrication is necessary as the motor is equipped with lifetime-lubricated bearings.

Note: Ozito Industries will not be responsible for any damage or injuries caused by the repair of the blower by an unauthorised person or by mishandling of the blower. This tool is designed for DIY use - use in commercial or industrial environments will void the warranty.

TROUBLESHOOTING

Problem	Cause	Remedy
Blower is not starting	Possible clogging	Clean the blower tube and blower outlet of any leaves or debris.
	Battery is low in charge	Charge battery
	Battery not inserted properly	Insert battery pack correctly
Blower is not operating at full capacity	Possible clogging	Clean the blower tube and blower outlet of any leaves or debris.
Motor stops while blowing	Battery has no power	Charge battery

SPARE PARTS

Spare Part

Battery pack 4.0Ah
Fast charger

Part No.

PXBP-400
PXCG-030

Spare parts can be ordered from the Special Orders Desk at your local Bunnings Warehouse.

For further information, or any parts not listed here, visit www.ozito.com.au or contact Ozito Customer Service:

Australia 1800 069 486

New Zealand 0508 069 486

E-mail: enquiries@ozito.com.au



BATTERY AND CHARGER SAFETY WARNINGS

THIS MANUAL CONTAINS IMPORTANT SAFETY AND OPERATING INSTRUCTIONS FOR YOUR BATTERY CHARGER.

1. Before using the charger read all instructions and cautionary markings on the charger, battery pack and the product using the battery pack.
2. This charger is not intended for any uses other than charging rechargeable batteries. Any other use may result in risk of fire, electric shock or electrocution.
3. Do not place any object on top of the charger or place the charger on a soft surface that may result in excessive internal heat. Place the charger in a position away from any heat source.
4. To reduce risk of damage to the electric plug and cord, pull by the plug rather than the cord when disconnecting the charger.
5. Make sure the cord is located so that it will not be stepped on, tripped over, or otherwise subjected to damage or stress.
6. An extension cord should not be used unless absolutely necessary. Use of an improper extension cord could result in the risk of fire, electric shock or electrocution.
7. Do not operate the charger if it has received a sharp blow, been dropped or otherwise damaged in any way. Have it checked by an electrician or power tool repairer.
8. Do not disassemble charger. Take it to an electrician or power tool repairer when service or repair is required. Incorrect reassembly may result in a risk of electric shock, electrocution or fire.
9. To reduce risk of electric shock, unplug the charger from the outlet before attempting any cleaning. Removing the battery pack will not reduce this risk.
10. Never attempt to connect 2 chargers together.
11. DO NOT store or use the tool and battery pack in locations where the temperature may reach or exceed 40°C (such as inside sheds or metal buildings in summer).
12. The charger is designed to operate on standard household electrical power (240 volts). Do not attempt to use it on any other voltage!
13. The battery pack is not fully charged out of the carton. First read the safety instructions and then follow the charging notes and procedures.
14. The longest life and best performance can be obtained if the battery pack is charged when the air temperature is between 18 - 24°C. Do not charge the battery pack in an air temperature below 10°C or above 40°C. This is important and will prevent damage to the battery pack.
15. Do not incinerate the battery pack even if it is seriously damaged or is completely worn out. The battery can explode in a fire.
16. Never attempt to open the battery pack for any reason. If the plastic housing of the battery pack breaks or cracks, immediately discontinue use and do not recharge.
17. During charging, the battery must be placed in a well ventilated area.

DESCRIPTION OF SYMBOLS

V	Volts	Hz	Hertz
~	Alternating current	W	Watts
dc/---	Direct current	∅	Diameter
mA	Milliamperes	no	No load speed
/min	Revolutions or reciprocation per minute		Double insulated
	Regulator compliance mark		Transformer Energy Rating (MEPS)
	Read instruction manual		Thermal cut-out protection
	Indoor use only		Warning
	Lithium Ion- battery		Do not use or store battery in temperatures exceeding 50°C
	Recycle battery		Do not put in the rubbish
	Do not incinerate		Do not get battery wet
			Wear eye and ear protection.
	Keep bystanders away. Do not operate whilst people especially children or pets are in the area.		
	Do not use in the rain or leave the blower outdoors while raining.		

CARING FOR THE ENVIRONMENT



Power tools that are no longer usable should not be disposed of with household waste but in an environmentally friendly way. Please recycle where facilities exist. Check with your local council authority for recycling advice.

Recycling packaging reduces the need for landfill and raw materials. Reuse of recycled material decreases pollution in the environment. Please recycle packaging where facilities exist. Check with your local council authority for recycling advice.



ELECTRICAL SAFETY



WARNING! When using mains-powered tools, basic safety precautions, including the following, should always be followed to reduce risk of fire, electric shock, personal injury and material damage.

Read the whole manual carefully and make sure you know how to switch the tool off in an emergency, before operating the tool. Save these instructions and other documents supplied with this tool for future reference.

The charger has been designed for 230V and 240V only. Always check that the power supply corresponds to the voltage on the rating plate.

Note: The supply of 230V and 240V on Ozito tools are interchangeable for Australia and New Zealand.



This tool's charger is double insulated therefore no earth wire is required.

If the supply cord is damaged, it must be replaced by an electrician or a power tool repairer in order to avoid a hazard.

Note: Double insulation does not take the place of normal safety precautions when operating this tool. The insulation system is for added protection against injury resulting from a possible electrical insulation failure within the tool.

Using an Extension Lead

Always use an approved extension lead suitable for the power input of this tool. Before use, inspect the extension lead for signs of damage, wear and ageing. Replace the extension lead if damaged or defective.

When using an extension lead on a reel, always unwind the lead completely. Use of an extension lead not suitable for the power input of the tool or which is damaged or defective may result in a risk of fire and electric shock.

The power supply for this product's charger should be protected by a residual current device (rated at 30mA or less). A residual current device reduces the risk of electric shock.



GENERAL POWER TOOL SAFETY WARNINGS



WARNING! Read all safety warnings and all instructions. Failure to follow the warnings and instructions may result in electric shock, fire and/or serious injury.

Save all warnings and instructions for future reference. The term "power tool" in the warnings refers to your mains-operated (corded) power tool or battery-operated (cordless) power tool.

1. Work area safety

- Keep work area clean and well lit.** Cluttered or dark areas invite accidents.
- Do not operate power tools in explosive atmospheres, such as in the presence of flammable liquids, gases or dust.** Power tools create sparks which may ignite the dust or fumes.
- Keep children and bystanders away while operating a power tool.** Distractions can cause you to lose control.

2. Electrical safety

- Power tool plugs must match the outlet. Never modify the plug in any way. Do not use any adapter plugs with earthed (grounded) power tools.** Unmodified plugs and matching outlets will reduce risk of electric shock.
- Avoid body contact with earthed or grounded surfaces, such as pipes, radiators, ranges and refrigerators.** There is an increased risk of electric shock if your body is earthed or grounded.
- Do not expose power tools to rain or wet conditions.** Water entering a power tool will increase the risk of electric shock.
- Do not abuse the cord. Never use the cord for carrying, pulling or unplugging the power tool. Keep cord away from heat, oil, sharp edges or moving parts.** Damaged or entangled cords increase the risk of electric shock.
- When operating a power tool outdoors, use an extension cord suitable for outdoor use.** Use of a cord suitable for outdoor use reduces the risk of electric shock.
- If operating a power tool in a damp location is unavoidable, use a residual current device (RCD) protected supply.** Use of an RCD reduces the risk of electric shock.

3. Personal safety

- Stay alert, watch what you are doing and use common sense when operating a power tool. Do not use a power tool while you are tired or under the influence of drugs, alcohol or medication.** A moment of inattention while operating power tools may result in serious personal injury.
- Use personal protective equipment. Always wear eye protection.** Protective equipment such as dust mask, non-skid safety shoes, hard hat, or hearing protection used for appropriate conditions will reduce personal injuries.
- Prevent unintentional starting. Ensure the switch is in the off-position before connecting to power source and/or battery pack, picking up or carrying the tool.** Carrying power tools with your finger on the switch or energising power tools that have the switch on invites accidents.
- Remove any adjusting key or wrench before turning the power tool on.** A wrench or a key left attached to a rotating part of the power tool may result in personal injury.
- Do not overreach. Keep proper footing and balance at all times.** This enables better control of the power tool in unexpected situations.

- Dress properly. Do not wear loose clothing or jewellery. Keep your hair, clothing and gloves away from moving parts.** Loose clothes, jewellery or long hair can be caught in moving parts.
 - If devices are provided for the connection of dust extraction and collection facilities, ensure these are connected and properly used.** Use of dust collection can reduce dust-related hazards.
- ## 4. Power tool use and care
- Do not force the power tool. Use the correct power tool for your application.** The correct power tool will do the job better and safer at the rate for which it was designed.
 - Do not use the power tool if the switch does not turn it on and off.** Any power tool that cannot be controlled with the switch is dangerous and must be repaired.
 - Disconnect the plug from the power source and/or the battery pack from the power tool before making any adjustments, changing accessories, or storing power tools.** Such preventive safety measures reduce the risk of starting the power tool accidentally.
 - Store idle power tools out of the reach of children and do not allow persons unfamiliar with the power tool or these instructions to operate the power tool.** Power tools are dangerous in the hands of untrained users.
 - Maintain power tools. Check for misalignment or binding of moving parts, breakage of parts and any other condition that may affect the power tool's operation. If damaged, have the power tool repaired before use.** Many accidents are caused by poorly maintained power tools.
 - Keep cutting tools sharp and clean.** Properly maintained cutting tools with sharp cutting edges are less likely to bind and are easier to control.
 - Use the power tool, accessories and tool bits etc. in accordance with these instructions, taking into account the working conditions and the work to be performed.** Use of the power tool for operations different from those intended could result in a hazardous situation.
- ## 5. Battery tool use and care
- Recharge only with the charger specified by the manufacturer.** A charger that is suitable for one type of battery pack may create a risk of fire when used with another battery pack.
 - Use power tools only with specifically designated battery packs.** Use of any other battery packs may create a risk of injury and fire.
 - When battery pack is not in use, keep it away from other metal objects, like paper clips, coins, keys, nails, screws or other small metal objects, that can make a connection from one terminal to another.** Shorting the battery terminals together may cause burns or a fire.
 - Under abusive conditions, liquid may be ejected from the battery; avoid contact. If contact accidentally occurs, flush with water. If liquid contacts eyes, additionally seek medical help.** Liquid ejected from the battery may cause irritation or burns.
- ## 6. Service
- Have your power tool serviced by a qualified repair person using only identical replacement parts.** This will ensure that the safety of the power tool is maintained.



BLOWER SAFETY WARNINGS

- Always wear adequate protective clothing when operating the blower to avoid injuries to face, eyes, hands, feet, head or hearing. Use safety glasses or a face shield, high boots or sturdy shoes, long trousers, work gloves, a hard hat and ear defenders.
- Do not start the tool when it is upside down or when it is not in the operating position.
- Switch the motor off and remove the battery when the tool is not being used, left unattended, being cleaned or being moved from one place to another.
- Do not operate the tool near people, especially children or pets. Turn it off if they get too close. Maintain a safe distance of at least 5m from other people when using the tool.
- Never direct the blower direction nozzle towards bystanders or pets. Never blow debris in the direction of bystanders or pets. The operator is responsible for accidents or hazards occurring to other people or their property.
- Do not handle the battery or the tool with wet hands and do not use the tool in the rain.
- Keep all the air intakes and the blower tube free of dust, lint, hair and other material that may cause a reduction in air flow.
- Keep a balanced and stable stance while using the tool. Do not switch on the tool in enclosed or poorly ventilated spaces or in the presence of inflammable and/or explosive substances such as liquids, gasses and powders.

- Do not get distracted and always concentrate on what you are doing. Use common sense. Never operate the tool when you are tired, sick or under the influence of alcohol or other drugs.
- Do not operate this appliance with long loose hair or loose fitting jewellery. Tie long loose hair back and remove loose fitting jewellery.
- Only operate the tool during broad daylight or with adequate artificial light.
- When the tool is not in use, store it in a dry place and out of reach of children.
- Only use the tool according to the instructions given in this manual.
- Check regularly that the screws are tight.



WARNING! When servicing, use only identical replacement parts. Use of any other parts may create a hazard or cause product damage. To ensure safety and reliability, all repairs should be performed by a qualified service technician.



WARNING! This appliance is not intended for use by young or infirm persons unless supervised by a responsible person to ensure that they can use the appliance safely. Young children should be supervised to ensure that they do not play with the appliance.