

evekare™

Instruction manual

EVK-0199-MCE

Smart Bidet Toilet Seat

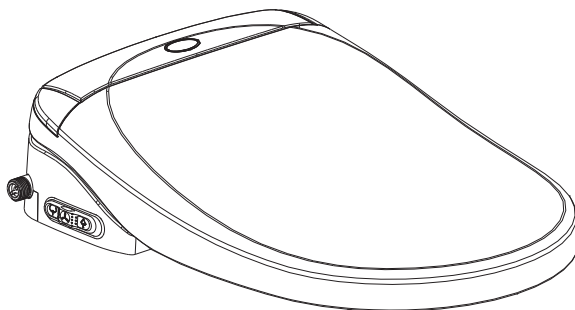

Rated voltage	220-240V~
Rated frequency	50/60Hz
Rated power	930-1100W
Waterproof	IPX4
Anti-electric shock TYPE	I



Aftermarket support and technical advice
E: warranty@evekare.com.au
T: 1300 794 086

- 
- Please read this manual thoroughly before installing & using the product.
 - Please do not hesitate to contact us if you have any questions in relation to the products installation or usage.
 - Please retain this manual for future reference.

Contents

Product contents.....	1
Specification.....	2
Product drawing.....	3
Power and water connection.....	3
Safety precautions.....	4
Functions.....	5
Product installation.....	6
Parts identification.....	8
Remote control operation.....	10
Usage instructions.....	11
Side panel operation.....	12
Remote control holder Installation.....	13
Extended periods of non use.....	14
Cleaning the appliance.....	15
Cleaning the water inlet filter.....	15
Nozzle cleaning.....	16
Troubleshooting.....	17
Product error codes.....	18
Spare parts.....	18

Product Contents

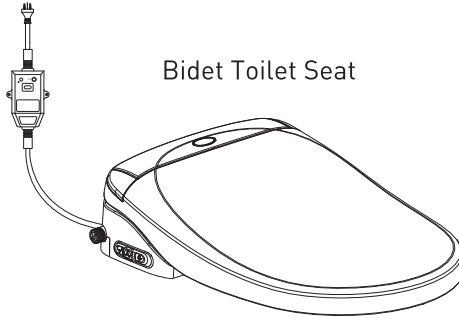

Bidet Toilet Seat

Remote Control



Remote Control

Remote Control Holder

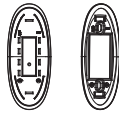

Double Sided Tape



AAA Battery (2pcs)



Seat Fixing Components (Each 2pcs)

Note: Top Mount & Bottom Mount Fixings Included



Hex Key



Holder Screws (Each 2pcs)



Instructions

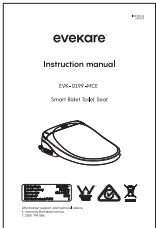

Tee



Dual check valve



30cm Flexible Inlet Hose

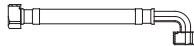

20cm Flexible Inlet Hose



Water Filter



Seat Mounting Plate

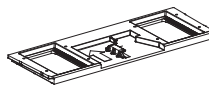

Seat Adjustment Plate (2pcs)

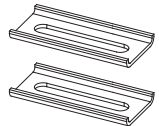

Specification

Model: EVK-0199-MCE

Rated voltage and rated frequency		220-240V~ 50/60Hz			
Length of cord		1.5m			
Washing functions	Water usage	Posterior cleaning	About 0.4-0.7L/min(hydraulic pressure of 0.2Mpa)		
		Feminine cleaning			
	Swing cleaning		Swing cleaning back and forth with water jet		
	Massage cleaning		Swing cleaning with pulsating water jet		
	The adjustment of the water flow and nozzle position		5 levels of adjustment		
	Heated water temperature range		35°C~42°C (Subject to the ambient temperature of install environment)		
	Safety device		Limiting the circuit by the software of over-temperature fast temperature control switch & temperature fuse		
Drying device	Drying temperature control		32°C-57°C (Subject to the ambient temperature of install environment)		
	Safety device		Temperature control switch & temperature fuse		
Seat cover	Temperature range		30°C~42°C (Subject to the ambient temperature of install environment)		
	Soft-close control for seat cover		Damper device		
	Safety device		Dual overheating protection via thermal switch as well as a separate thermal fuse.		
	LED night light		LED light in seat turns on automatically in low light situations		
Cleaning	Antibacterial seat cover/ nozzle		Anti-bacterial surface		
	Self-rinsing nozzle		Auto self-rinsing cycle after each use		
Deodorization	Deodorization method		Activated carbon deodorant		
Rated power	930~1100W	Maximum power	1600W	IP Rating	IPX4
Temperature of supplied-water	4°C~35°C	Ambient temperature		3°C~40°C	
Pressure of supplied-water	Minimum water supply conditions: 0.07MPa Maximum water supply conditions: 0.75MPa				

Product drawing

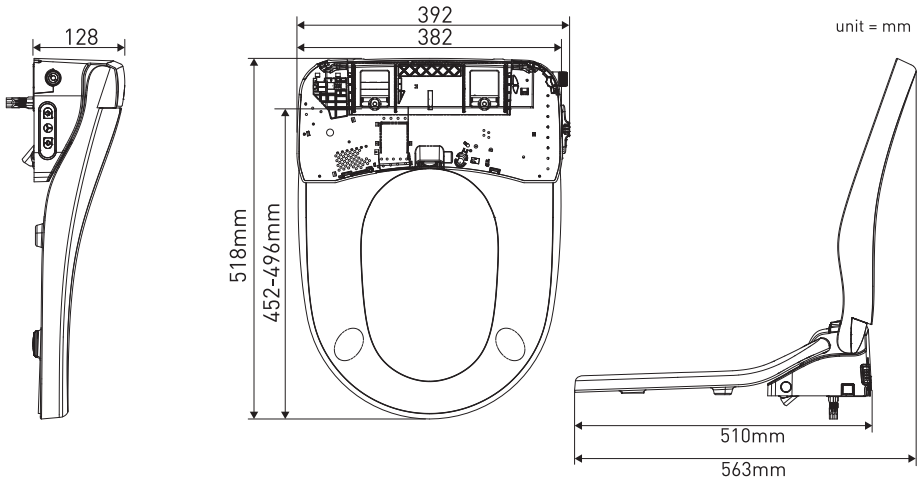

Power and water connection

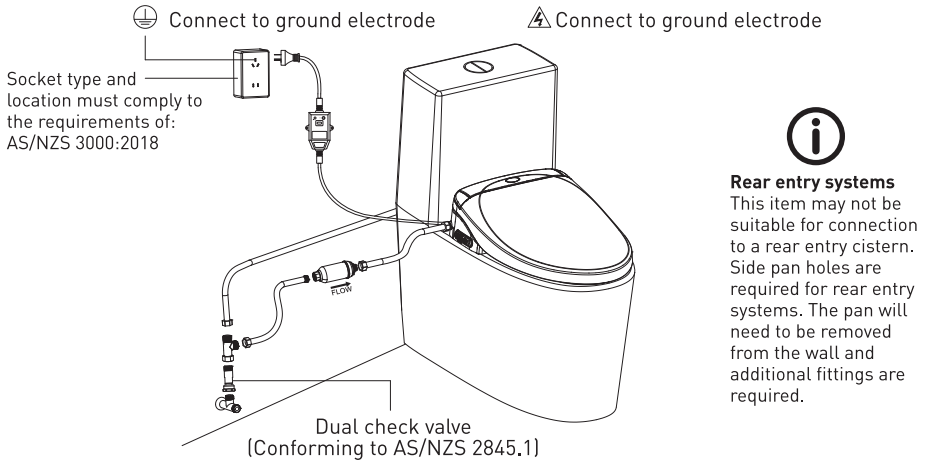

Warning: A high hazard reduced pressure zone (RPZ) backflow prevention device is required. It must be installed upstream of the toilet douche seat or flexible hose connection.



Testing and commissioning backflow prevention devices

All new installations of backflow prevention devices must be tested and commissioned by a licensed plumber. Results must be recorded along with inspection and maintenance reports. All testable backflow prevention devices must also be tested annually by a licensed plumber and the results recorded in the inspection and maintenance report. Specific requirements for RPZ installation relative to bidet toilet seats may vary from area to area within Australia and should be checked with local authorities and certifiers prior to installation.

NOTE: The installation of this product must comply with the requirements of AS/NZS 3500.1 and AS/NZS 3000.

Safety precautions

In order to avoid injury and property damage, please follow the below safety warnings and precautions. Read this manual carefully before installation, and install the appliance in strict accordance with the instructions. Please retain these instructions for future reference.

 WARNING	
	This appliance is not intended for use by persons (including children) with reduced physical, sensory or mental capabilities, or lack of experience and knowledge, unless they have been given supervision or instruction concerning use of the appliance by a person responsible for their safety.
	Do not operate this appliance if the supply cord or plug is damaged, has malfunctioned, or has been dropped or damaged in any manner. In the event of a product malfunction shut off the electrical and water supply immediately and return the appliance to an authorised service facility for examination, electrical or mechanical adjustment or repair. Do not attempt to repair the appliance yourself.
	If the external flexible cable or cord of this appliance is damaged it shall be exclusively replaced by the manufacturer or his service agent, or a similar qualified person in order to avoid a hazard.
	Do not install this appliance in a location where water might be splashed onto it, or in a location subject to excessive moisture or condensation. Ensure install location has adequate ventilation to avoid damage to electrical components due to high humidity.
	The water supplied to the appliance must only be potable (drinking) water, do not connect the appliance to a non potable water source (eg recycled or ground water) as doing so may lead to skin irritation or infection.
	Do not hard wire this appliance or modify the supply cord in any way, doing so will void the warranty.
	The flexible water inlet hoses must not be stretched, twisted, kinked or exposed to naked flames or corrosive agents. Doing so could lead to the failure of the hose and property damage due to flooding that will not be covered by warranty. It is recommended that the flexible water inlet hoses are replaced every 5 years.
	Do not use corrosive or abrasive cleaning products to clean the appliance as doing so will damage the unit. Clean the toilet seat using warm soapy water, unplug the appliance when cleaning and ensure that electrical components are not exposed to water.
	Do not stand or place heavy objects onto the appliance.
	Unplug and drain the appliance if you do not intend on using it for an extended period of time.
	Be aware of low temperature burn. The seat and dryer temperature should be set to low or off for children, the elderly, or people with sensory issues. Such users should be supervised when they are using the appliance.
	Do not connect the appliance to the power outlet until installation is complete, doing so may cause the appliance to malfunction.

Functions

Cleansing function

Posterior cleaning	Posterior cleaning mode
Feminine cleaning	Feminine cleaning mode
Spray position adjustment	Choice of 5 nozzle positions
Water flow adjustment	Choice of 5 water flow strengths
Massage cleaning	Water flow pulsates between strong and soft
Swing cleaning	Nozzle moves back and forth during cleaning cycle

Comfort functions

Heated seat	4 settings - off, low, medium & high
Air dryer	Drying function with 5 heat settings
Water temperature adjustment	Change the temperature of water for cleaning functions, 5 heat settings
Deodorization	Activated carbon filter, function automatically engaged when user is seated
Seat sensor	Sensor in seat is activated when user is seated, majority of functions will not operate unless sensor is activated
Soft close function	Soft-closed toilet cover and seat
LED	LED light illuminates the toilet in low light situations
Prevent low temperature burn	To prevent scalding users, the seat temperature will decrease automatically after user is seated for 15mins

Cleaning function

Anti-bacterial	Toilet seat and cover as well as water nozzle made of anti-bacterial treated plastic
Nozzle rinsing	Nozzle has an auto rinsing cycle after each spray cleaning cycle
Water drainage port	After extended periods of non use, drain the water from the unit by pressing the water drain button

Product installation

a. Insert the hex bolts into the rectangular steel mounting brackets

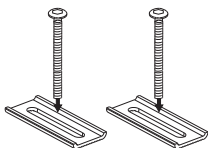

b. Insert the hex bolts with the adjustment plates into the seat mounting plate

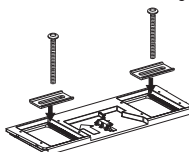

Option 1: Bottom fixing (recommended providing access to underside of pan is available)

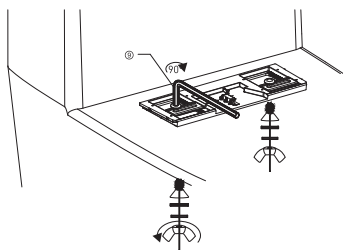

1. Place seat mounting plate assembly onto the pan with the hex bolts going through the fixing holes in the pan. The arrow on the seat mounting plate must point to the back of the pan.
2. From the underside of the pan, place the dome washer, flat washers & wingnut onto the threaded end of the hex bolt.
3. Semi-tighten the assembly and install the seat to gauge correct position of the seat mounting plate. Adjust the seat mounting plate forward or backwards as needed.
4. Once correct position has been found, fully tighten the assembly by holding the wingnut and using the hex key to tighten the bolt.

Option 2: Top fixing

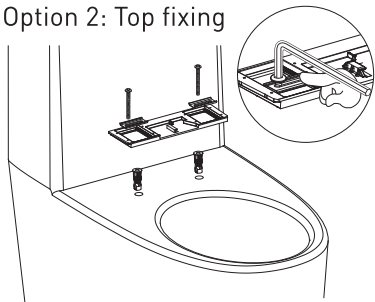

1. Push the nylon spigot into the fixing holes of the toilet pan.
2. Place seat mounting plate assembly onto the pan with the hex bolts going into the nylon spigots. The arrow on the seat mounting plate must point to the back of the pan.
3. Semi-tighten the assembly and install the seat to gauge correct position of the seat mounting plate. Adjust the seat mounting plate forward or backwards as needed.
4. Once correct position has been found, fully tighten the assembly using the hex key supplied.

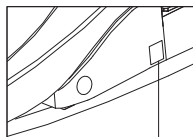
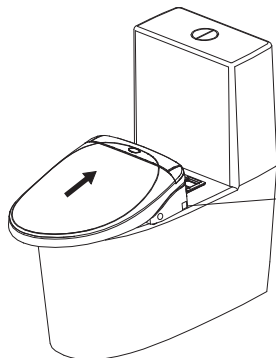

Seat release button

Tips for installing/uninstalling the seat onto the mounting plate

1. To install the seat, slide the seat onto the mounting plate as shown in the diagram on the left. You will hear and feel the seat click into position once installed.
2. To uninstall the seat, press the seat release button whilst gently pulling the seat towards the front of the pan.

Product installation (continued)

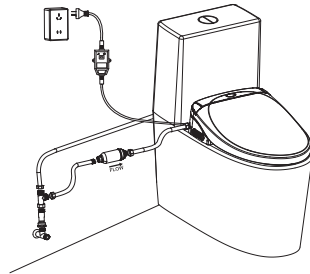
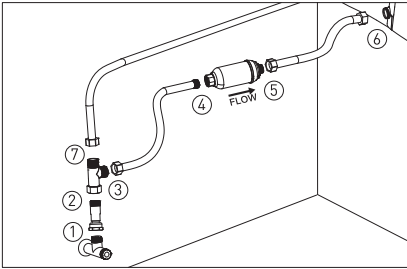

- 1, Connect the dual check valve to the cistern cock
- 2, Connect tee to the dual check valve
- 3, Connect the short flexible inlet hose (20cm) to the tee.
- 4, Connect the filter to the short flexible inlet hose (20cm).
- 5, Connect the long flexible inlet hose (30cm) to the filter.
- 6, Connect the long flexible inlet hose (30cm) to the water inlet of the bidet seat.
- 7, Connect the existing flexible inlet hose (supplying the toilet cistern) to the tee.

Note:

This appliance has been individually quality tested after manufacture, it is not uncommon for a small amount of residual test water to be left in the appliance or it's fittings.

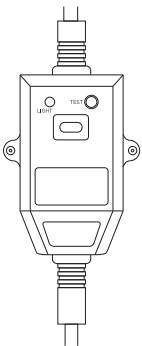

This appliance is fitted with an inline safety switch. When the appliance is connected to the power supply the light on the safety switch will glow red.

If the power supply is on but the light on the safety switch is off, it would indicate there is a leakage fault.

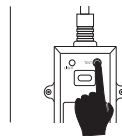

1. Pressing the test button simulates an earth leakage fault. The safety switch should engage and the appliance will turn off.

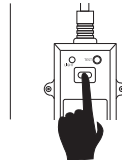

2. After testing the safety switch, hit the reset button to reset the safety switch. The appliance should turn back on and begin going through it's start up checks.

Note:

Do not connect the power supply to the appliance until it is installed and the water supply has been connected. Doing so could lead to the appliance malfunctioning.

Parts identification

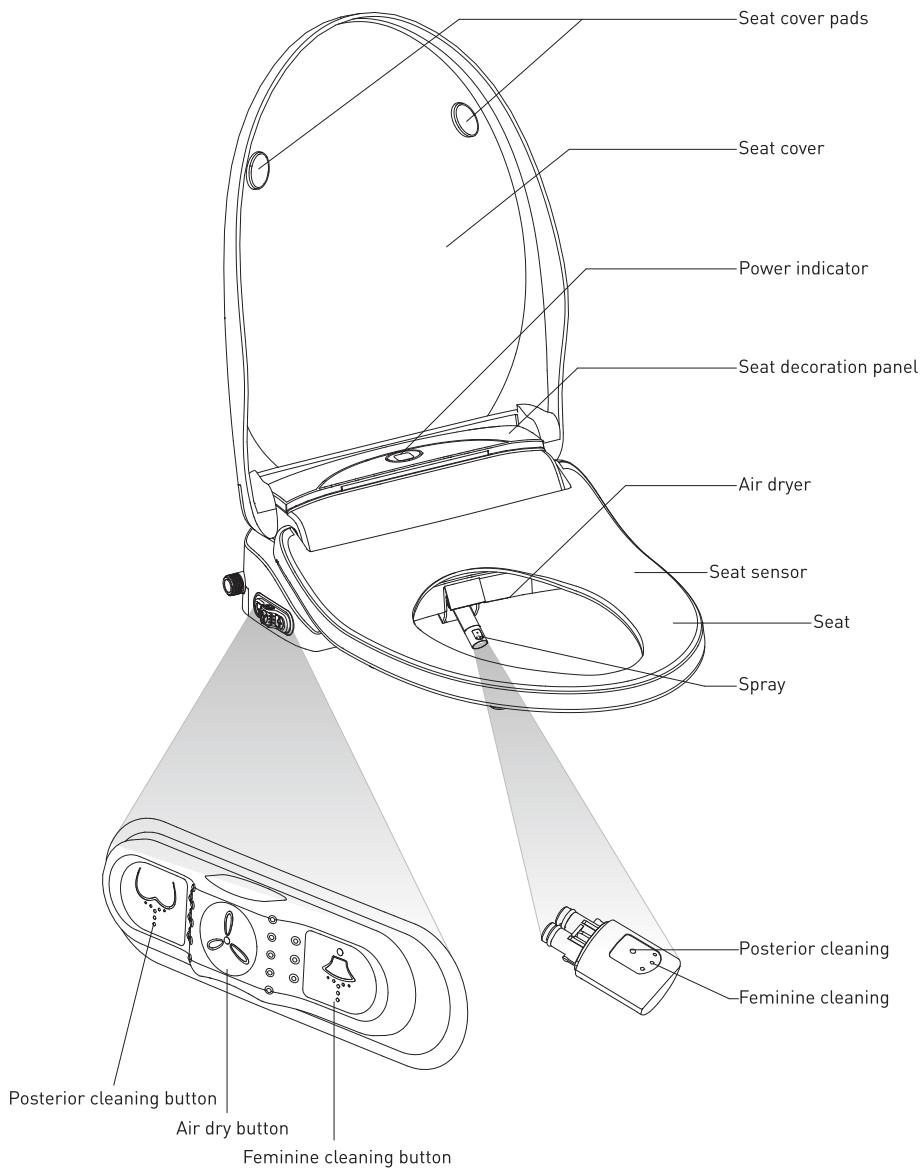

Parts identification (continued)

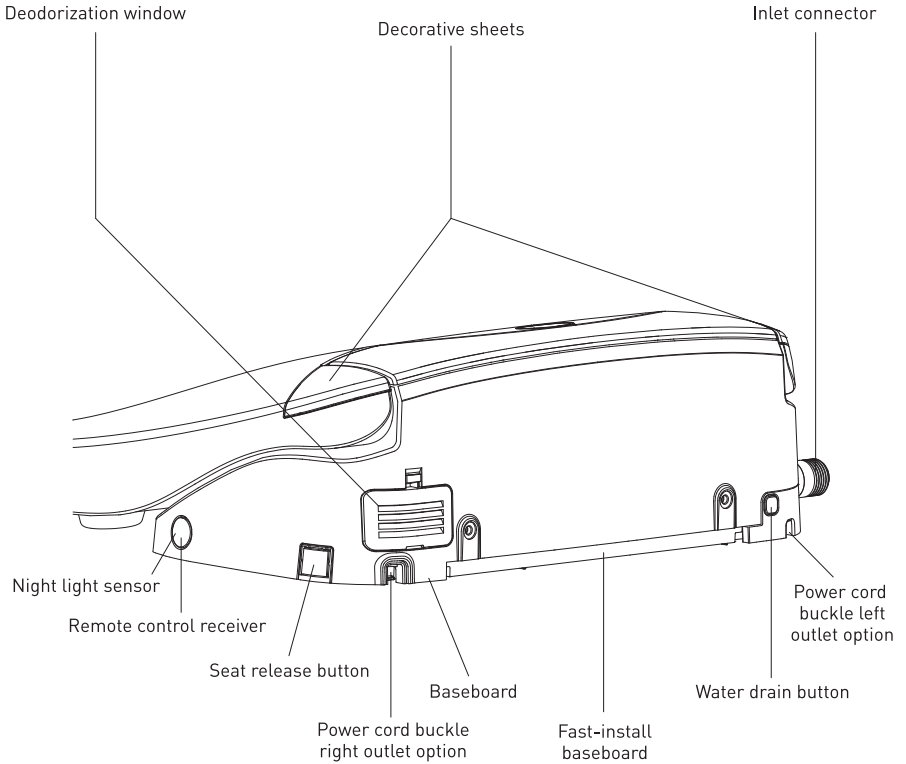

Remote control operation

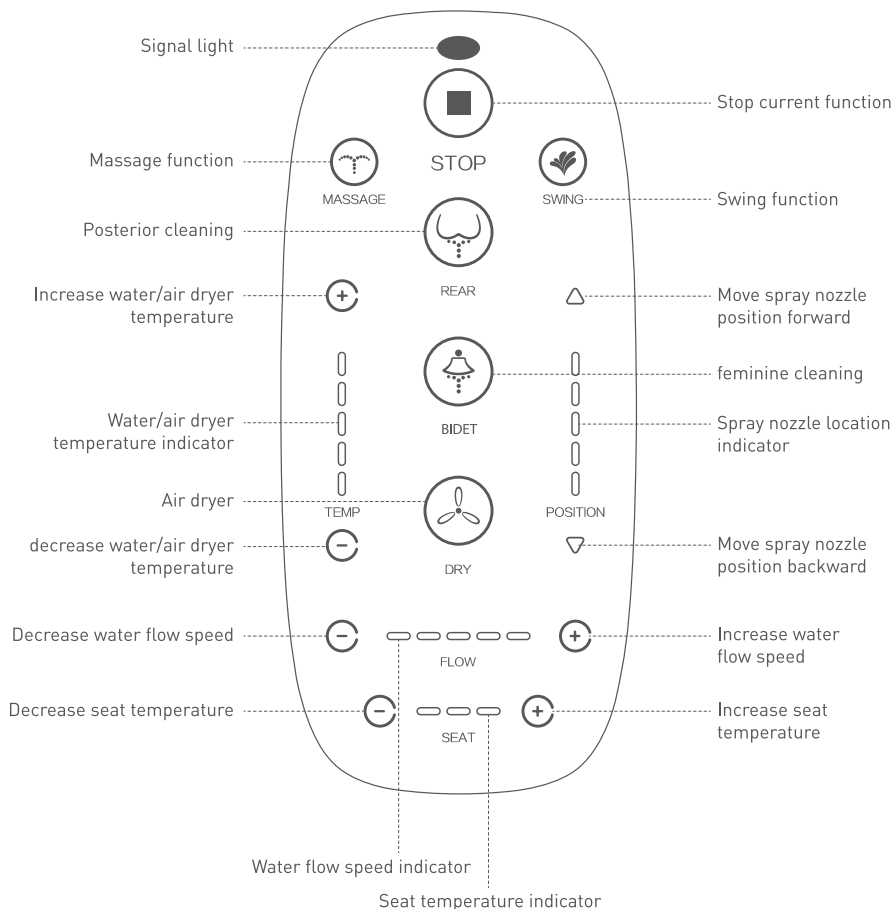

Usage instructions



Stop

- ▶ Pressing the stop button stops all cleaning and drying functions immediately.



Posterior cleaning

- ▶ Pressing the posterior cleaning button will start the cleaning function. Function will automatically turn off after 2 minutes. Otherwise function can be stopped by pressing the stop button.
- ▶ Function will not operate unless user is seated and seat sensor is activated.



Feminine cleaning

- ▶ Pressing the feminine cleaning button will start the cleaning function. Function will automatically turn off after 2 minutes. Otherwise function can be stopped by pressing the stop button.
- ▶ Function will not operate unless user is seated and seat sensor is activated.



Dry

- ▶ Pressing the dry button will start the air dryer function. Function will automatically turn off after 2 minutes. Otherwise function can be stopped by pressing the stop button.
- ▶ Function will not operate unless user is seated and seat sensor is activated.

Massage



- ▶ When in posterior/feminine cleaning mode massage mode can be activated by pressing the massage button. Press once for pulsating massage, twice for powerful massage.
 - 1, Pulsating massage mode: the nozzle sprays stream of water that alternates between high and low flow speed to clean the body.
 - 2, Powerful massage mode: the nozzle sprays a stream of pressurized water to clean the body.



Swing

- ▶ When in posterior/feminine cleaning mode swing mode can be activated by pressing swing button. When activated the cleaning nozzle will begin moving back and forth cleaning a larger area. Press the swing button a second time or the stop button to turn swing mode off. Note: Swing mode and massage mode can be activated simultaneously.

Water temperature setting



Under posterior or feminine cleaning mode, the initial temperature setting is 3, press the plus button to increase the water temperature, press minus button to decrease the water temperature. There are a total of 5 temperature settings, the current setting will be illuminated on the remote control handset.

Air dryer temperature setting

Under air dry mode the initial temperature setting is 3, press the plus button to increase the air temperature, press minus button to decrease the air temperature. There are a total of 5 temperature settings, the current setting will be illuminated on the remote control handset.

Spray position adjustment



Under Posterior and feminine cleaning mode, the initial spray nozzle position is set to 3 (middle). Pressing the top arrow will move the spray nozzle towards the front of the toilet pan. Pressing the bottom arrow will move the spray nozzle towards the back of the pan.

Usage instructions (continued)



Water flow speed adjustment

► When in posterior/feminine cleaning mode initial water flow speed setting is 3, press the plus button to increase the water flow speed, press minus button to decrease the water flow speed. There are a total of 5 flow speeds, the current setting will be illuminated on the remote control handset.



Seat temperature adjustment

► The heated seat function has 4 settings: off, low, medium and high. Press the plus button to increase the seat temperature, press minus button to decrease the seat temperature. The current setting will be illuminated on the remote control handset.

Note:

Be aware of low temperature burn. The seat and dryer temperature should be set to low or off for children, the elderly, or people with sensory issues. Such users should be supervised when they are using the appliance.

To reduce the risk of low temperature burn, the unit will decrease seat temperature automatically after the user has been continuously seated for a period of 15mins.

Do not forcefully push the remote or side panel buttons as this could damage the controls.

Side panel button instructions

Posterior & Feminine cleaning function:

Function 1: Press posterior or feminine cleaning button to start cleaning cycle.

Function 2: Press posterior or feminine cleaning button for a 2nd time to stop cleaning cycle.

Function 3: Hold the posterior or feminine cleaning button down for more than 2 seconds to begin auto clean mode. Auto clean mode consists of: 30 seconds of swing clean, 60 seconds swing powerful massage and 2 minutes of air dry.

Hold the posterior cleaning button down for 5 seconds to turn on/off the LED light.

Note: The LED light automatically turns on in low light conditions.

Dry function:

Function 1: Press the dry button to start dry the air dryer.

Function 2: Hit the dry button for a 2nd time to stop the air dryer.

Side panel nozzle position adjustment:

Function 1: Under posterior or feminine cleaning mode, slide the button assembly forwards or backwards to control the spray nozzle position.

Function 2: Under posterior or feminine cleaning mode slide the button assembly forwards or backwards to control the water flow speed. Forwards for strong flow, backwards for low flow.

Note: Hold the dry button down for 2 seconds to switch between the two functions mentioned above. The unit will beep once to indicate that the function has been swapped between nozzle adjustment and flow speed adjustment.

Function 3: Under air dry mode, slide the button assembly forwards or backwards to control the air dryer temperature. Slide forwards for higher temperature, backwards for low.

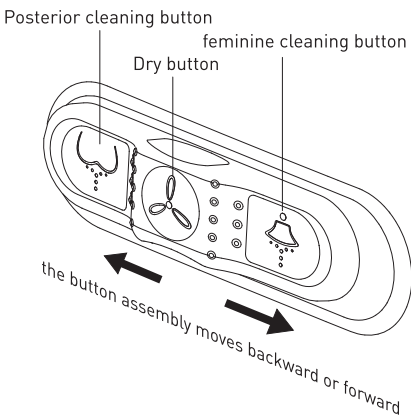

- If the unit beeps twice when adjusting the button assembly it means the adjustment limit has been reached.

Remote control holder installation

Method A 1. Place the magnet into the slot on the back of the remote control holder as shown in figure 1. Once in position, clip the backing piece onto the holder.

Note: Pay attention to the magnet polarity when installing the magnet. Check it is correct by placing the remote onto the holder the right way up. The remote should stay attached to the holder.

2. Put the double sided tape onto the back of the remote control holder.

3. Clean and dry the wall surface upon which the holder is to be installed. Note that the user must be able to reach the remote when seated on the toilet.

4. Remove the backing strip from the double sided tape and press into position on the wall until a solid bond is formed.

Note: This method is applicable to glazed tiles, glass and smooth walls.

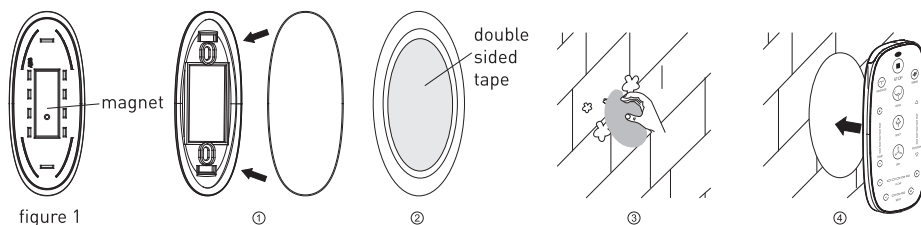

Method B 1. Drill 2 x 6mm diameter holes to a depth of 30mm. These holes should be 49mm apart vertically.

Note: The user must be able to reach the remote when seated on the toilet. Before drilling ensure there are no utilities (eg water pipes, electrical cabling) in the vicinity of the hole locations.

2. Install the wall plugs into the drilled holes, align the fixing holes of the remote control holder backing plate with the wall plugs and then insert the screws and tighten. Put the magnet into the remote control holder as shown in figure 2 and then click the remote control holder onto the backing plate.

Note: Pay attention to the magnet polarity when installing the magnet. Check it is correct by placing the remote onto the holder the right way up. The remote should stay attached to the holder.

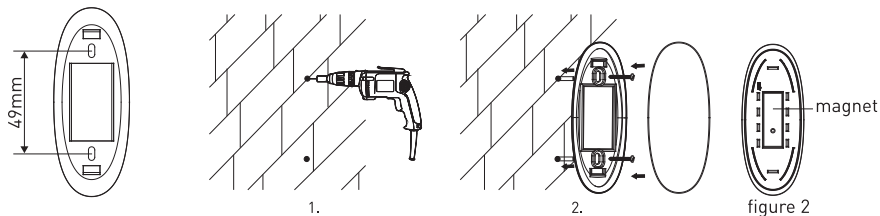

Once the holder is installed place the remote onto the holder, the magnet should hold it in place.

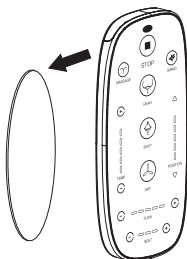

Note * Ensure the remote is installed in a fixed location (i.e. do not install the remote on the back of a door).

* Do not install the remote in a location where it is exposed to water or where it is possible for the remote to fall into water.

Extended periods of non use

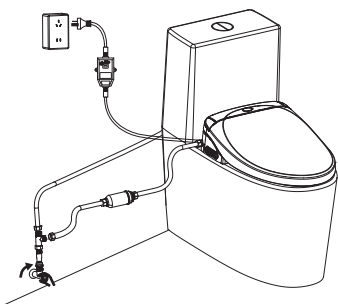

1. Turn off the power point and unplug the cord from the socket. Turn off the water supply at the cistern cock, uninstall the flexible inlet hoses (drain residual water left in hoses into a bucket).

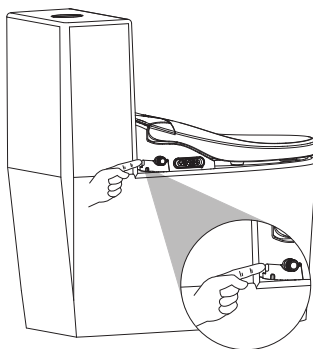

2. Hold down the water drain button until all water has been drained from the unit.

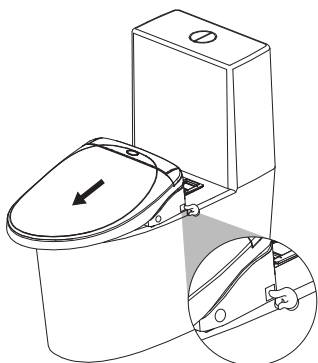

3. Press the seat release button and remove the seat from the mounting plate on the pan. Store the appliance and all components in a dry, safe place until re-installation is needed.

Note:
When re-installing the appliance please check and test the appliance before using.

Cleaning the appliance

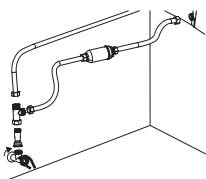

1. Turn off the water supply at the cistern cock.

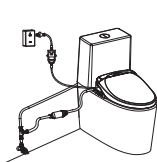

2. Turn off the power supply and unplug the cord from the power outlet.

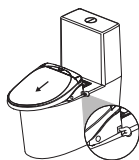

3. Press the seat release button and remove the seat from the pan.



4. Using a sponge or soft cloth and warm soapy water, clean the toilet pan and the area around the seat mounting plate. Then wipe down the seat and seat cover.

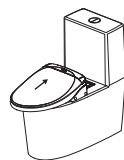

5. Re-install the seat and ensure the appliance is completely dry before re-connecting the water and power supply.

Cleaning the water inlet filter

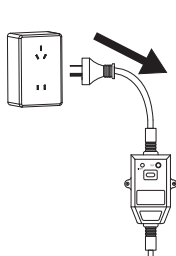

1. Turn off the power supply and unplug the cord from the power outlet.

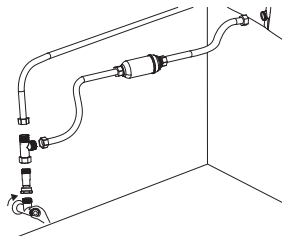

2. Turn off the water supply at the cistern cock.

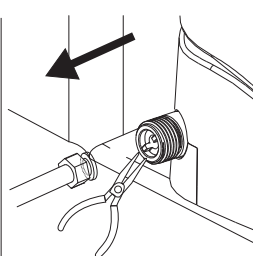

3. Using needle nose pliers, remove the water inlet filter.

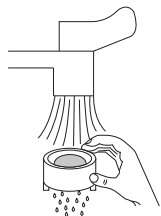

4. Clean the water inlet filter.

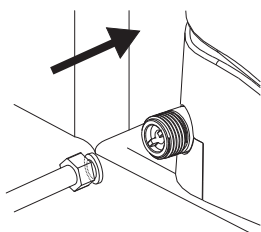

5. Re-install the water inlet filter into the water inlet. Re-connect the flexible inlet hose.

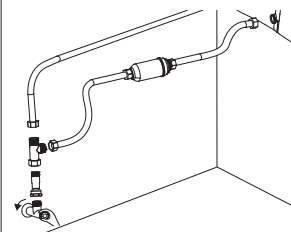

6. Turn on the water supply at the cistern cock, then re-connect the appliance to the power supply.

Nozzle cleaning

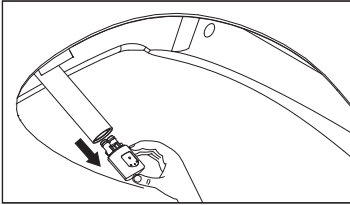

1. To clean the nozzle, hold down the posterior cleaning and feminine cleaning buttons on the wireless remote simultaneously for 2seconds. The spray rod and nozzle will extend out of the seat. Remove the nozzle head.

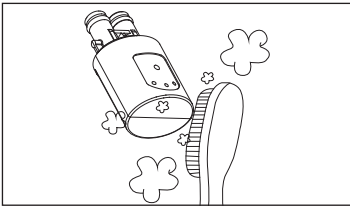

2. Wipe the nozzle head and spray rod with a toothbrush, sponge or soft cloth with warm soapy water or mild detergent.

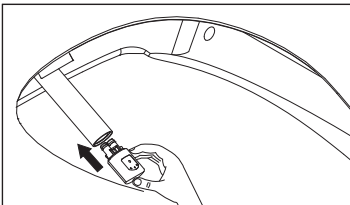

3. Re-install the nozzle head onto the spray rod by holding the rod and pushing the nozzle head into place. Press the stop button to finish cleaning, the spray rod and nozzle will automatically retract back into seat. **DO NOT** push the spray rod and nozzle back into the seat by hand as doing so could cause the appliance to malfunction.

NOTE:

Do not use corrosive or abrasive chemicals or cleaning products to clean the appliance. Doing so will cause damage that will not be covered by the products warranty.











Common troubleshooting

Problem	Possible Cause	Solution
The appliance does not function at all.	There is no power being supplied to the appliance or the inline safety switch has tripped.	Check that the power supply is turned on & reset the inline safety switch if needed.
There is no response when posterior cleaning, feminine cleaning or air dryer functions are selected.	There is no (or limited) water supply to the appliance.	Check that the cistern cock is turned on fully.
		Check inlet hose fittings, ensure hoses are not kinked.
		Check whether the inline filter and inlet connection filter are blocked, clean/replace the filters if necessary.
	The seat sensor is not being activated.	Ensure user is sitting on seat correctly, sensor will beep when activated.
A cleaning or drying cycle stops suddenly before the cycle has timed out.	The user has got off the seat or has moved and deactivated the seat sensor.	Ensure user is sitting on seat correctly, sensor will beep when activated. Re-start cleaning or drying cycle.
Deodorization function is not working.	The seat sensor is not being activated.	Ensure user is sitting on seat correctly, sensor will beep when activated.
	Activated carbon filter block or deodorization window may be blocked.	Remove the deodorization window and clean, replace the activated carbon filter if necessary.
Deodorization function continues to work after user leaves.	The deodorization function will continue to work for 20 seconds in order to remove the residual odour after the user leaves.	This is normal operation.
The toilet seat is not heating.	Seat heating function is set to off.	Adjust the seat temperature with remote control.
Water is not heated during posterior and feminine cleaning cycles.	Low water temperature is set.	Adjust the water temperature with remote control.
Air dryer temperature is not warm.	Low air dryer temperature is set.	Adjust the drying temperature with remote control.

Product error codes

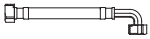
Error code	Cause	Recommended action
The power light flashes once every 2 seconds	A fault has been detected with the water inlet temperature sensor	<p>Stop using the appliance immediately. Turn off the power supply and un-install the appliance. Return the appliance to the place of purchase or contact the service line on 1300 794 086</p>
The power light flashes twice every 2 seconds	A fault has been detected with the water outlet temperature sensor	
The power light flashes three times every 2 seconds	A fault has been detected with the air dryer temperature sensor	
The power light flashes four times every 2 seconds	A fault has been detected with the seat temperature sensor	
The power light flashes seven times every 2 seconds	A fault has been detected with the air dryer fan	
When the appliance is in use the inline safety switch constantly trips	An electrical current leakage fault has been detected	

Spare parts list

1	KSP0060	Seat mounting plate	
2	KSP0061	Seat fixing kit	
3	KSP0062	Remote control	
4	KSP0063	Remote control holder kit	
5	KSP0064	Tee	
6	KSP0065	External water filter	
7	KSP0066	30cm flexible inlet hose	
8	KSP0067	20cm flexible inlet hose	
9	KSP0068	Spray nozzle	
10	KSP0069	Dual check valve	
11	KSP0070	Activated carbon filter	

Spare parts can be ordered from the original place of purchase.

