

# LL117

## LakeLand

Oliveri®

### RIGHT HAND BOWL SINK

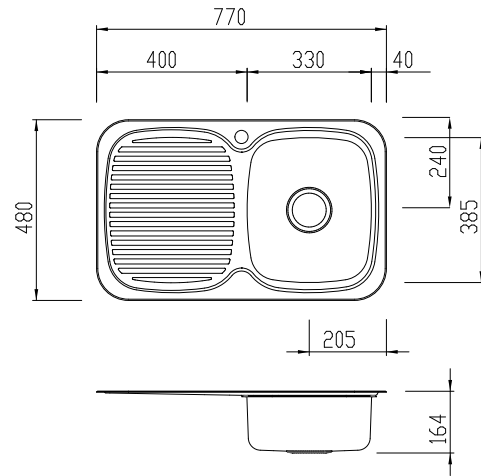

### INCLUDED ACCESSORIES

AC14

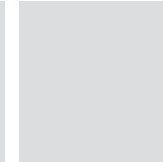
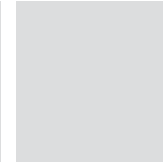
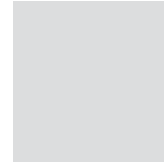
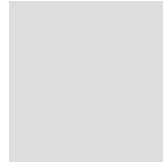
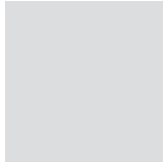

### RECOMMENDED TAPWARE

NW7310



SS913



### OPTIONAL ACCESSORIES

AC01

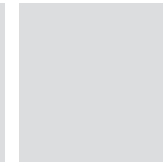
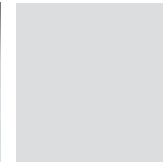
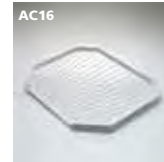

  
**Australian Made Sink**  
Oliveri

### SPECIFICATIONS

#### Description

Single bowl inset sink with drainer

#### Sink Size

770W x 480H

#### Main Bowl

330W x 385H x 155D / 17L

#### Construction

2 piece, bowls & drainer seam welded

#### Material

304 grade, 18/10 polished stainless steel (0.8mm thick)

#### Installation

Inset recommended.

#### Fixings

Adjustable clips and sealing foam supplied

#### Cut Out Template

750 x 460 x 95mm radius

#### Min Cabinet Size

500mm

#### Tap holes

Available 0 or 1 tap hole (specify when ordering)

#### Waste fittings

1 x 90mm basket waste included

#### Overflow

Available, conditions apply

#### Carton Size

780 x 490 x 170mm

#### Weight

4.5kg

#### Warranty

Lifetime manufacturer's warranty (refer to oliverisinks.com)

For more information call **1300 13 7465** or visit **www.oliverisinks.com**

