



**SPECIAL  
ORDERS**

# **CUSTOM MADE BARRIER DOORS**



Available at  
**BUNNINGS**  
warehouse

The Cowdroy Barrier Door range offers you a selection of custom made quality screen doors in a range of designs and colours that will not only protect your home from unwanted pests but will also enhance and compliment the look of your door entrance.

All doors come with the following:

- Heavy duty extruded aluminium frame
- Double cylinder lock with deadlocking and privacy functions
- 2 hinges per door
- 21 standard powder coat colours to choose from
- A range of popular optional accessories
- Custom made to your sizes
- 5 year replacement warranty
- Australian made

## Barrier Door Designs

There are 2 designs to choose from, the "Superior" and the "Colonial".

### SUPERIOR

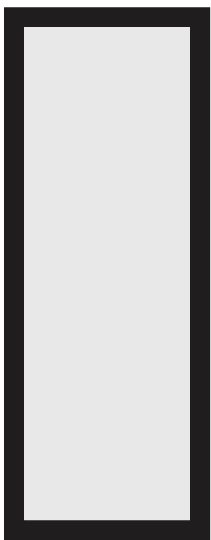

Maximum Size 2500mm x 1300mm

○ SUPERIOR

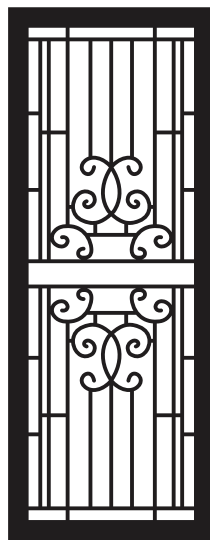

Maximum Size 2230mm x 920mm  
Minimum Size 1929mm x 760mm

○ SP56AB

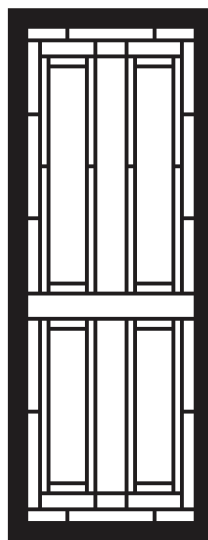

Maximum Size 2230mm x 920mm  
Minimum Size 1819mm x 760mm

○ SP34AB



Maximum Size 2230mm x 920mm  
Minimum Size 1819mm x 760mm

○ SP14AB

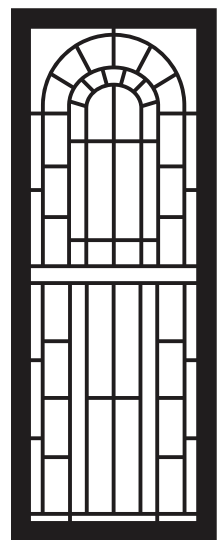

Maximum Size 2230mm x 920mm  
Minimum Size 1929mm x 760mm

○ SP13AB

### COLONIAL

#### Superior Range

Features a high quality and impact resistant #316 grade woven stainless steel mesh fitted inside the frame by way of a double locking wedge and an acrylic adhesive.

The black finish of the mesh is designed to be neutral so as to enhance your view, not the mesh.

The "Superior" door combines strength and quality with an unobtrusive view.

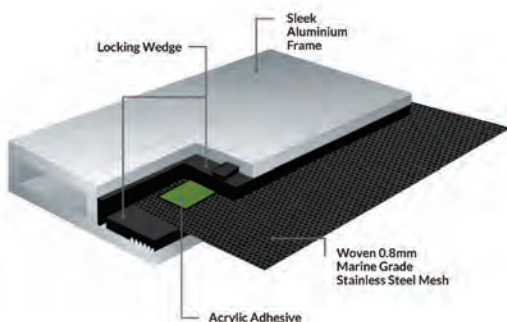

#### Colonial Range

Features a decorative cast aluminium panel fitted within the frame and finished with a quality fibreglass mesh.

There are 4 highly popular panel inserts available in the "Colonial" range, each of which are finished in the same durable powder coat as the frame.

The "Colonial" door combines elegance with quality and will give your home a new look.

## Choose colours

Door Finish	Default Lock Finish	Default Door Closer Finish (Optional)
	White	White
	White Birch	White Birch
	Primrose	Primrose
	Black	Black
	Stone Beige	Stone Beige
	Black	Black
	Black	Black
	Black	Black
	Black	Black
	Black	APO Grey
	Black	Black
	Black	Black
	Black	Black
	Black	Black
	Black	Black
	Black	Black
	Bronze	Bronze
	Brown	Brown
	Woodland Grey	Woodland Grey
	Hawthorn Green	Hawthorn Green
	Black	Black

You may also choose which colour lock or closer you would like from the range shown above.

## Measure

### Height

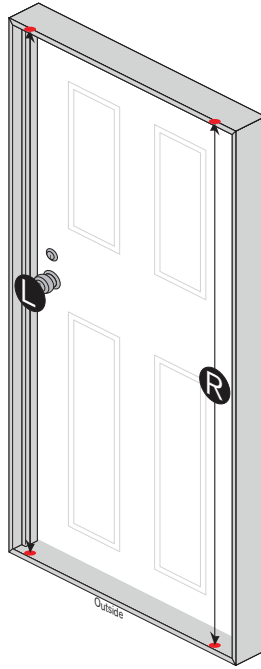

<b>L</b>	mm
<b>R</b>	mm

### Width

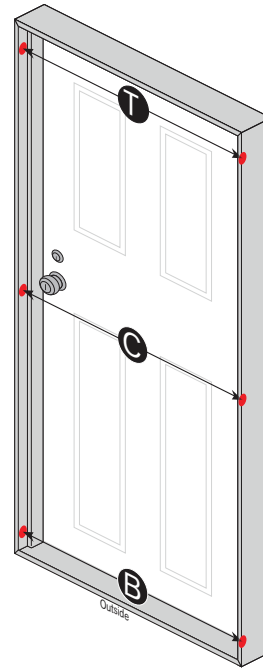

<b>T</b>	mm
<b>C</b>	mm
<b>B</b>	mm

### Lock/Handle

Check the space between your existing door lock and the outside face of your jamb.

The gap required to ensure your new barrier door fits is minimum 20mm.

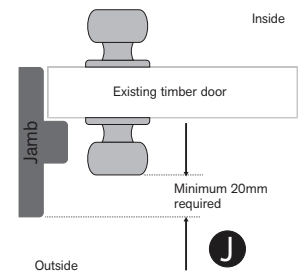

<b>J</b>	mm
----------	----

### Handle Height

Nominate your new barrier door handle height. Enter your distance from the sill up to the centre of the lever.

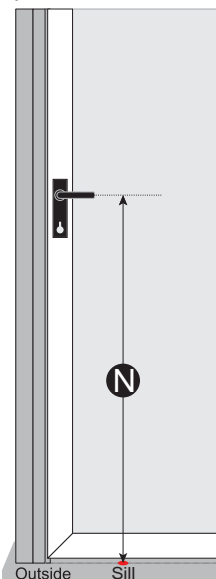

<b>N</b>	mm
----------	----

**IMPORTANT**  
Ensure the height of the handle of your new barrier door will not collide with the handle of your existing door when closed.

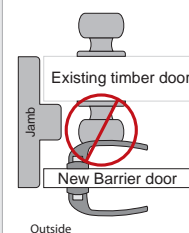

### Choose your handle side

From the outside looking in, on which side would you like the handle on your barrier door?

Usually it is the same side as the handle on your existing door.

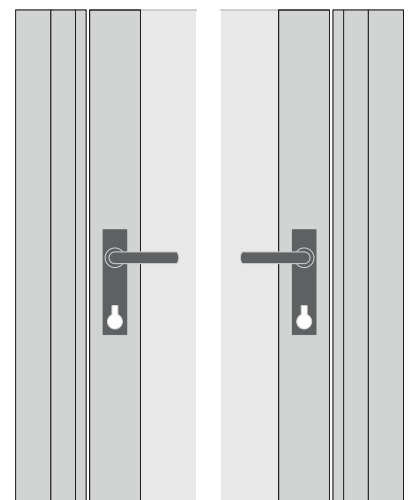

Left Hand Side
  Right Hand Side

# BARRIER DOOR OPTIONAL EXTRAS

## ✓ TRIPLE LOCK

Upgrade your lock option to an Austral EKIT triple lock for increased locking security.

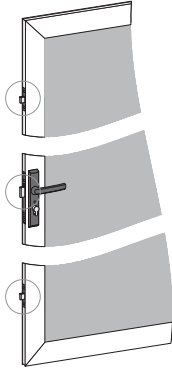

## ✓ DOOR CLOSER

Add a pneumatic door closer to automatically return your door to its closed position.

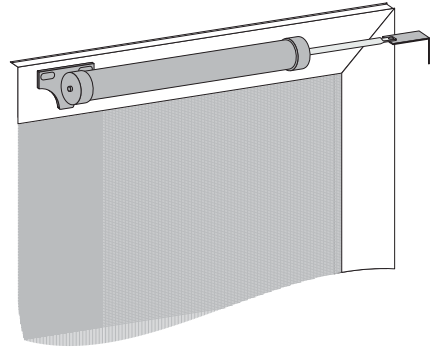

## ✓ PET DOORS\*

\*Suitable for "Superior" door only

Pet doors are ideal for those with indoor pets. Available in 3 sizes, Small (190x240mm), Medium (255x305mm) & Large (260x400mm)



## ✓ PET MESH

Protect your pet by upgrading your mesh to a pet-friendly soft mesh.

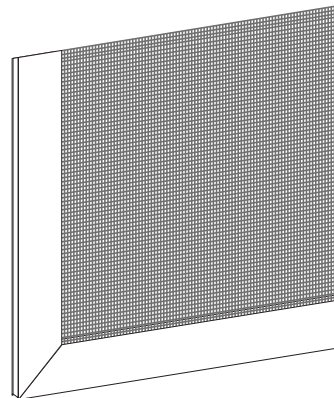

## ✓ BUG SEAL

Consider a bug seal to help keep out those unwanted pests. All bug seals are finished in the same colour as your door.

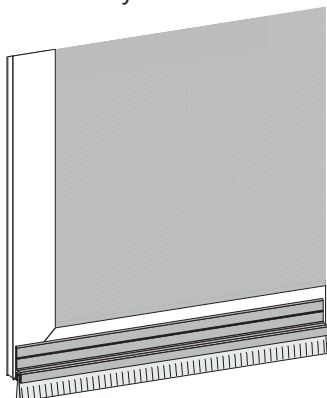

## ✓ ONE-WAY MESH

For increased privacy upgrade your mesh to one-way mesh, which is difficult for people to see in, but easy to see out.

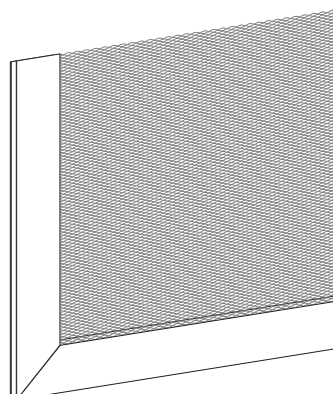

# BARRIER DOOR ORDER FORM



## STANDARD INCLUSIONS

I/N - Item No.

### 1. Select door type

SUPERIOR	SP13AB	SP14AB	SP34AB	SP56AB
I/N - 2029984 All doors up to 930mm W	I/N - 2029986 For all doors sizes	I/N - 2029987 For all doors sizes	I/N - 2029988 For all doors sizes	I/N - 2029989 For all doors sizes

I/N - 2029985  
Doors wider than 930mm

Refer to the **Barrier Door Designs** detail on page 2 of this brochure for all minimum and maximum door sizes.

### 2. Enter your door opening sizes in column A.

	A. (Opening size)	Less	B. (Make-to size)
<b>L</b>	mm	-10mm	mm
<b>R</b>	mm	-10mm	mm
<b>T</b>	mm	-8mm	mm
<b>C</b>	mm	-8mm	mm
<b>B</b>	mm	-8mm	mm

### 3. Enter your door colour. (Refer colour range on page 3.)

### 4. Select your handle side. (From the outside looking inwards)

LEFT  RIGHT

### 5. Enter your handle height. (From sill to centre of handle lever)

**N** mm

(NOTE: For Triple Lock option - fittings will be located at an equal distance above and below this nominated handle height)

### 6. Select your handle colour. (Available colours shown below)

White  White Birch  Primrose  Stone Beige  Black  Bronze  Brown  Wood Grey  Hawth. Green

## OPTIONAL EXTRAS

I/N - Item No.

(Please tick all required options)

a. Triple Lock.  I/N - 2029995

b. One-Way Mesh.  I/N - 2029996

Select colour. (Available colours shown below)

White  White Birch  Primrose  Stone Beige  Black  Bronze  Brown

c. Stainless Steel Mesh.  I/N - 2029998

(Add-on for Colonial Doors only)

d. Paw-Proof Pet Mesh.  I/N - 2029997

(Add-on for Colonial Doors only)

e. Perspex Pet Door.  SMALL I/N - 2029990

(Add-on for Superior Doors only)

MEDIUM I/N - 2029991

LARGE I/N - 2029992

HINGE SIDE

HANDLE SIDE

f. Door Closer.  I/N - 2029994

Select colour. (Available colours shown below)

White  White Birch  Primrose  Stone Beige  Black  APO Grey  Bronze  Brown  Wood Grey  Hawth. Green

g. Bug Seal.  I/N - 2029993

h. Take your completed form to the Special Orders Desk at your local Bunnings Warehouse to complete your order.

CSO number	
Customer name	
Customer contact No.	
Bunnings store	
Bunnings store No.	
Team Member name	
Date	



# 3 Easy Steps to a Custom Made Barrier Door



**Follow the brochures simple instructions to help make your selection.**

Measure carefully, check twice and write clearly with a black ink pen.



**Take your completed form to the Special Orders desk to place your order.**

Ensure you have correctly filled out all the required fields and that you have nominated your door style, colour and desired options.



**Your Special Order will be delivered to store for customer pick up.**

Delivery is 10 working days for east coast metropolitan areas, 10 - 15 working days for east coast regional areas and up to 20 working days for all other areas in Australia.



## Available Through Special Orders