

# ASSEMBLY INSTRUCTION FOR MAXI ULTRA H1

**WARNING:** Serious injury or death can be caused by toppling furniture

**Help prevent tip-over:**

- Anchor this product to a wall or other suitable surface
- Check anchors regularly
- Avoid placing TVs on top unless the TV is also anchored
- Use drawer locks to prevent children climbing

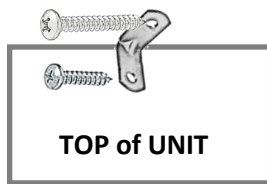

When attaching unit to wall put safety bracket in middle of unit with 16mm pan head screw then 25mm pan head screw into wall. For plasterboard without a stud it is recommended to use a plug with screw (not provided).

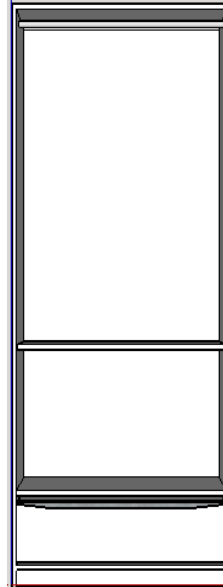

## PARTS IDENTIFICATION LIST

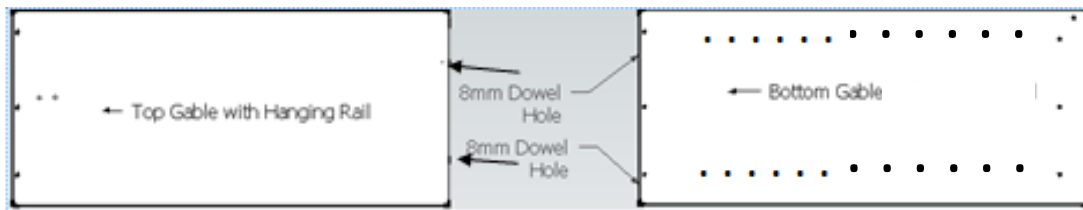

2x CAM SHELF

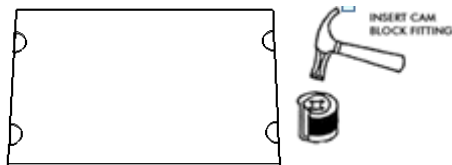

1 BOTTOM KICK



2x FIXED SHELF













1x .....BACKING

1x .....BACKING



1x 30mm HANGING



NO	MODEL	DESCRIPTION	QTY	NO	MODEL	DESCRIPTION	QTY
1		CONFIRMAT SCREWS 50mm x 5mm	15	6		CAMS	4
2		WHITE CAPS	15	7		CAM PINS	4
3		DOWELS	4	8		16mm PAN HEAD SCREWS	1
4		BACKING NAILS	60	9		25mm PAN HEAD SCREWS	1
5		16mm WOOD SCREW	2	10		"L" SAFETY BRACKET	1

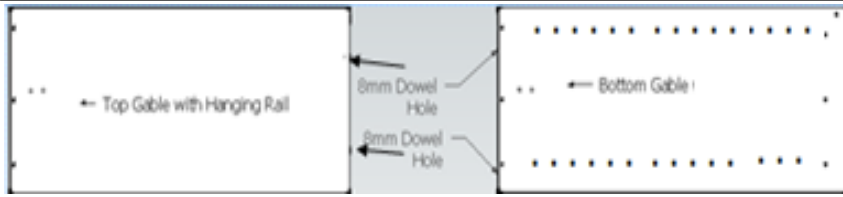

### RUNNER PLACEMENT

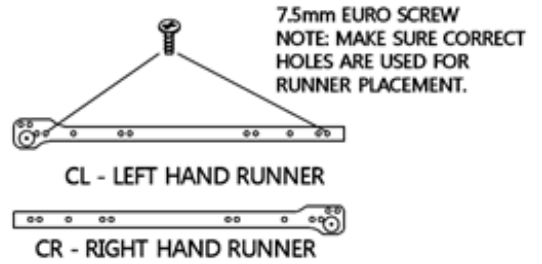

Take your gables and lay them out flat you should have 2 Top & 2 Bottom gables.

Using a little of wood glue (NOT SUPPLIED) in your pre-drilled holes, insert your Wood Dowels into 2 of the holes and push your top into your bottom gables.

PLACE YOUR RUNNERS INTO THE DESIGNATED HOLES MAKING SURE YOU HAVE THE RUNNER FACING TO THE FRONT.

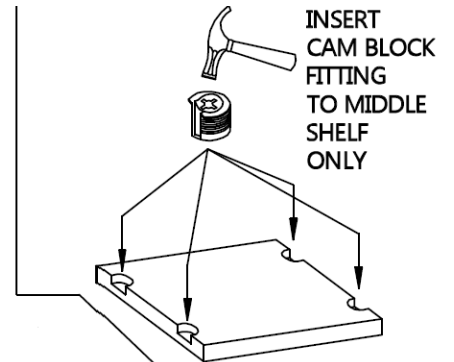
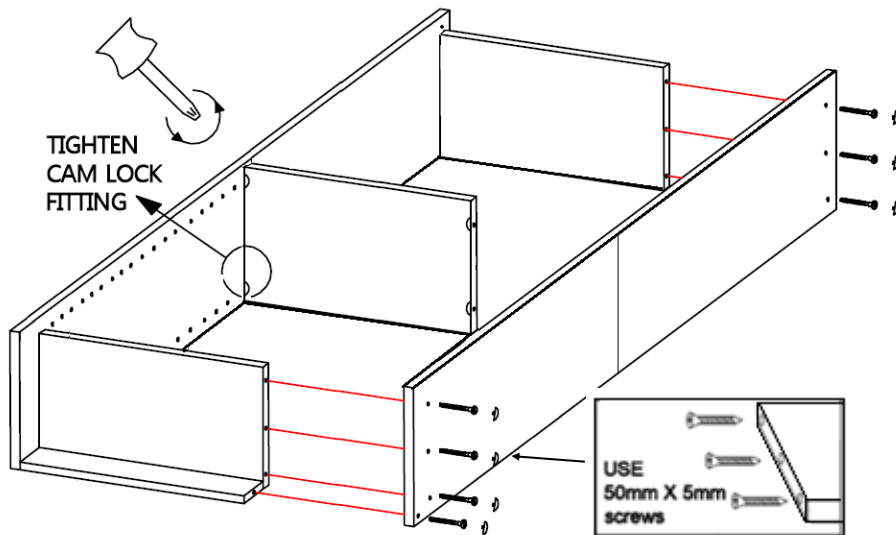

**IMPORTANT**  
PLACE THE FITTING OVER HOLE, KEEPING THE SQUARE, EDGE OF THE FITTING PARALLEL TO THE FACE OF THE BOARD, KNOCK IN CAREFULLY

ALIGN FIXED SHELVES + KICK BOARD TO SIDE GABLES TIGHTEN ALL SCREWS AND CAP.

**FOLD OUT BOTH TOP AND BOTTOM BACKS PROCEED TO NAIL THEM INTO POSITION MAKING SURE YOU ARE SQUARE.**

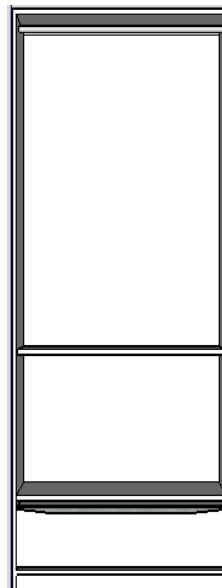
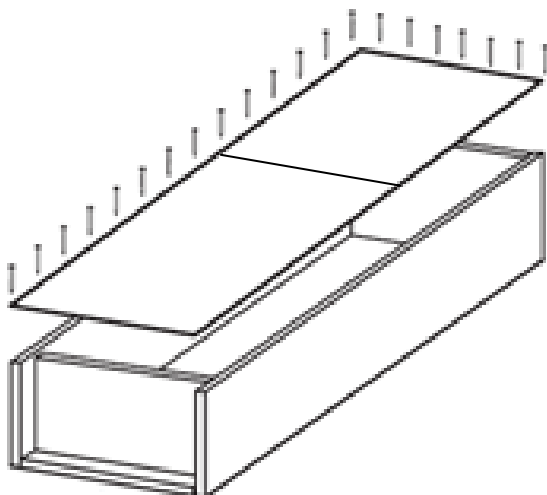

**THERE IS NO SCREWS NEEDED FOR THE NEXT STEP.**

**TAP INTO POSITION YOUR FLANGES INTO THE HOLES PROVIDED AND INSERT YOUR HANGING RAIL.**

**YOUR UNIT IS NOW READY TO BE PUT INTO PLACE.**

**NEXT. GO TO YOUR DRAWER ASSEMBLY SHEET ON HOW TO CREATE YOUR DRAWER.**

## INSTRUCTIONS TO SUIT 750 WIDE UNITS

### HOW TO ASSEMBLE YOUR DRAWER

#### **STEP 1.**

LAYOUT YOUR DRAWER PIECES FLAT AS PER DESIGN WITH PRE-DRILLED HOLES FACING UP. START WITH THE BACK OF THE FRONT DRAWER AND PLACE YOUR DOWELS & CAM PIN IN THE PRE-DRILLED HOLES ON EITHER SIDE AS INSTRUCTED BELOW.

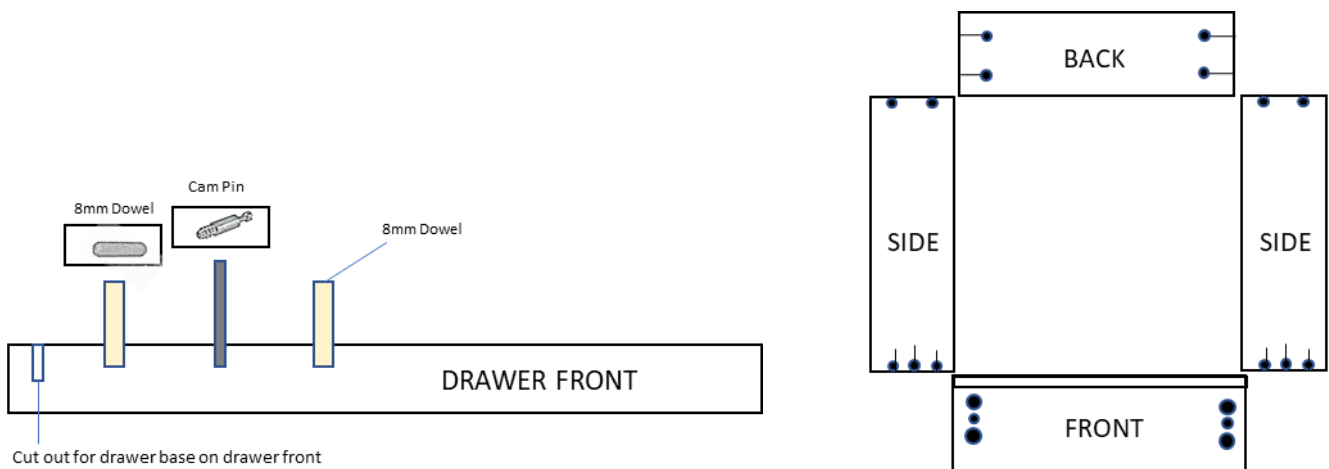

#### **STEP 2.**

GRAB YOUR FIRST SIDE AND INSERT YOUR CAMS INTO THE HOLE PROVIDED ON THE OUTSIDE OF THE DRAWER SIDE GENTLY AS PER INSTRUCTIONS BELOW.



IMPORTANT NOTICE:

PLACE THE FITTING OVER THE HOLE KEEPING THE SQUARE EDGE OF THE FITTING PARALLEL TO THE FACE OF THE BOARD, KNOCK IN **CAREFULLY**.

PUSH THE SIDE INTO THE FRONT DOWELS & PIN AND THEN CAREFULLY USING A SCREW DRIVER TURN UNTIL IT LOCKS IN. REPEAT THIS PROCESS WITH THE OTHER SIDE.

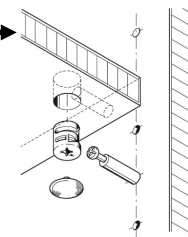

NOW PLACE YOUR LAST PIECE BETWEEN THE TWO SIDES USING THE SCREWS: NO 1 SUPPLIED, SCREW INTO THE SIDES OF THE BACK DRAWER PIECE.

---

## DRAWER ASSEMBLY

---

### **STEP 3.**

*USING THE HANDLE SCREW (NO:6) ATTACHED THE HANDLE TO THE BACK OF THE DRAWER FRONT INTO THE PREDRILLED HOLES ALLREADY PROVIDED.*

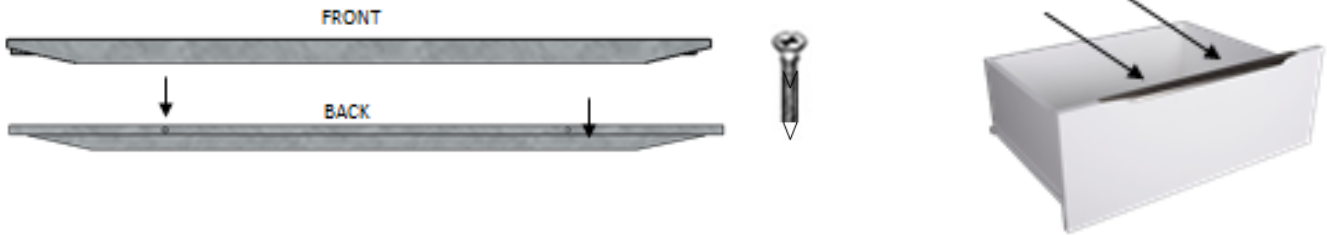

---

### **STEP 4.**

*PLACE YOUR DRAWER RUNNER ON THE BOTTOM OF THE USING THE .....SCREWS DRILL INTO YOUR DRAWER AND REPEAT FOR THE OTHER SIDE.*

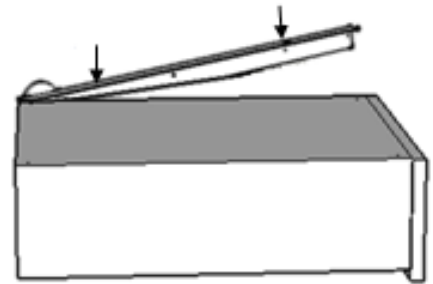

---

PICTURE OF YOUR FINISHED DRAWER



---

## **WARRANTY**

---

Our goods come with guarantees that cannot be excluded under the Australian Consumer Law. You are entitled to a replacement or refund for major failure.

10 Year Warranty

- If the purchaser has a fault or defect with this product, the purchaser needs to contact Multistore Industries (Aust) directly on (07) 3208 6799 and state date of purchase, place of purchase and proof of purchase.
- Multistore Industries (Aust) will replace any faulty or defect parts at no cost to the customer. A replacement will be sent to you as soon as possible, or product can be exchanged at the store of purchase.
- This warranty is in addition to other rights and remedies of the customer under law.

Sincerely,

Multistore Industries (Aust) Management