

Note: This document is just a sample.
Visit EzyFit Website for more instructions.

EZY-FIT DIY Roller Shutters



















Installation Instructions

Face-Fit, Brick/Concrete Wall
AC Electric Motor, without Packer



This page is intentionally left blank.

Face-Fit on Brick/Concrete walls with AC Electric Motor

Qty.	Part	
Parts (provided with roller shutter)		
1	Pelmet complete with roller shutter system	
2	Shutter guide	
2	Bottom guide cap or	
1	Sill angle	
2	Packing profile (if needed)	
1	Control switch	
12	Wall plugs (6.5 x 35 mm)	
12	Screws (6 x 35 mm)	
12	Tek screws (if using packing profile)	
12	Hole caps	
6	Pop rivets (3.2 mm)	
1	Height/limit adjustment tool for motor	
1	Wiring instructions (for qualified electrician to use)	
1	Paper template	
Required tools (not included)		
1	6.5 mm drill bit	
1	10 mm drill bit	
1	6.5 mm Straight masonry bit or 6.5 mm SDS-plus masonry bit (if using hammer drill)	
1	12 mm Straight masonry bit or 12 mm SDS-plus masonry bit (if using hammer drill)	
1	Rivet gun	
1	Cordless drill/driver or Hammer drill	
1	Philips screw driver or Driver bit	

- Please ensure you have thoroughly read and understood these instructions and the safety notes before commencing installation.
- make sure that the roller shutter in the package has not sustained any major transport damage, and if so, photos must be taken and sent to us via email or post.
- The safety and installation instructions must be followed accurately. Failure to do so will result in a void warranty.
- These instructions are designed for you to easily install your roller shutter using simple tools. However, call us on 1800 633 136 if you are in any doubt about how to install and operate the roller shutter or about any safety issues.
- The wiring of 240 V AC Electric Motors should be conducted by a qualified electrician according to local and national standards and regulations.
- Wear personal protective equipment before you start to help avoid self-injury. For example: safety glasses, safety boots, ear plugs, hard hats, long sleeves, gloves, etc.
- The installation videos are also available on our website: www.ezyfitrollershutters.com.au



1. Unwrap the pelmet box and guides and put them on the ground

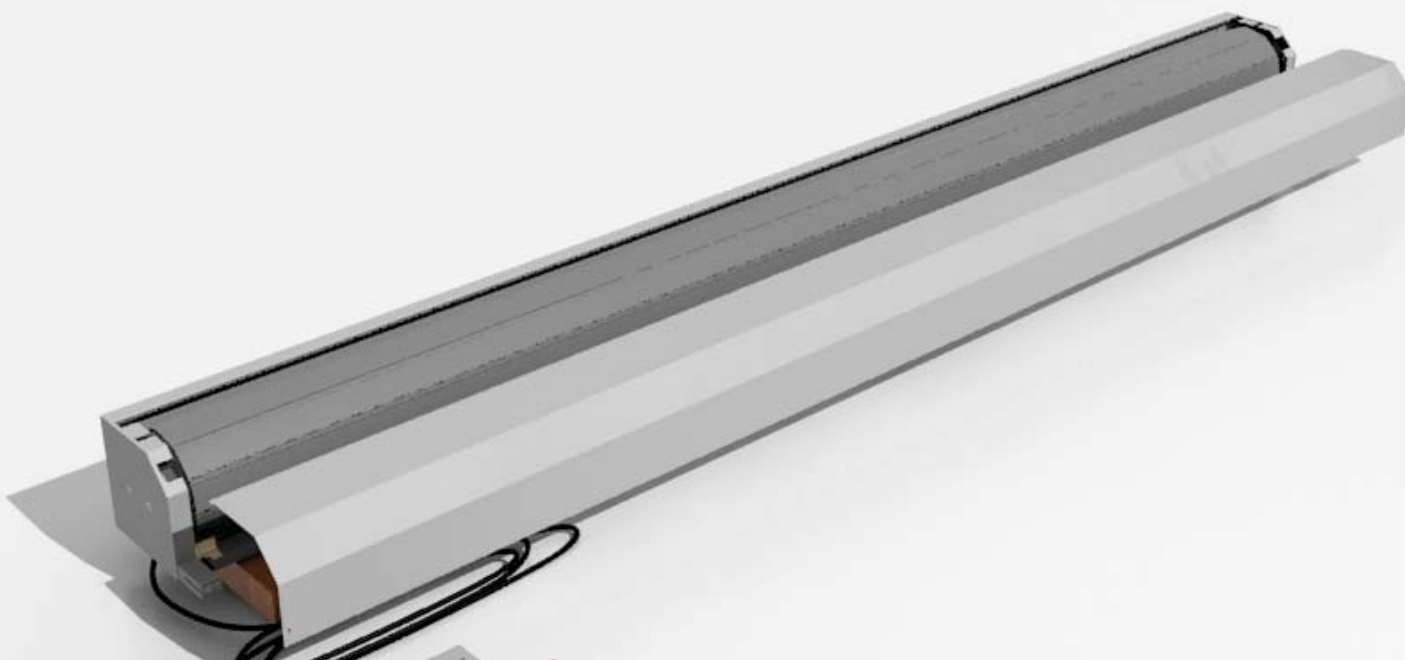

2. Remove the front cover by sliding it out



3. Make sure metallic legs are in place on both sides. If not, slide them in place.



4. Place one of the guides on the wall, keeping the bottom flush with the bottom of the opening.

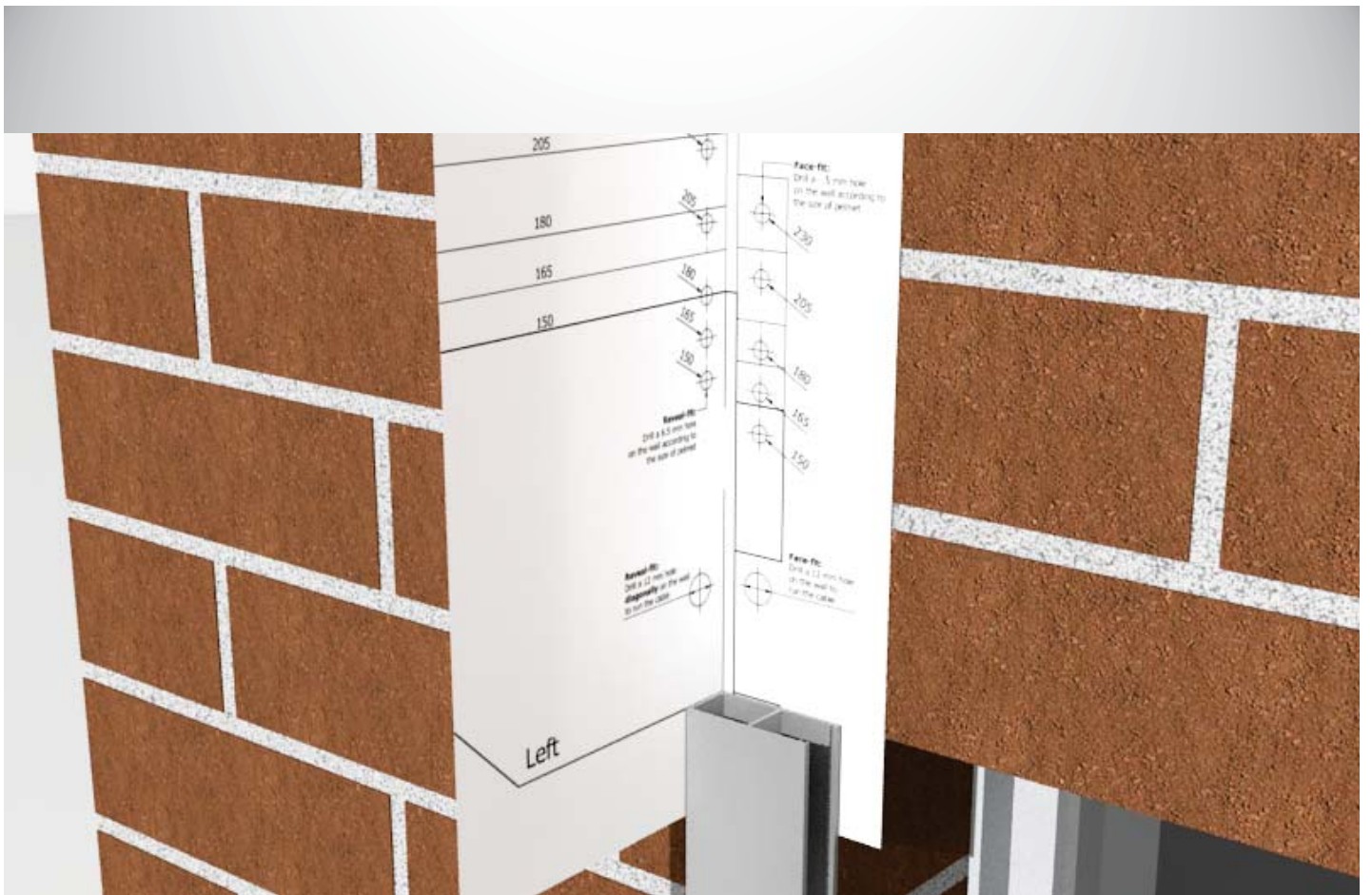

5. Use the provided paper template to estimate the final position of pelmet box and securing points.
Fold the template and place the guide over the hatched area



6. Mark the securing point for pelmet box

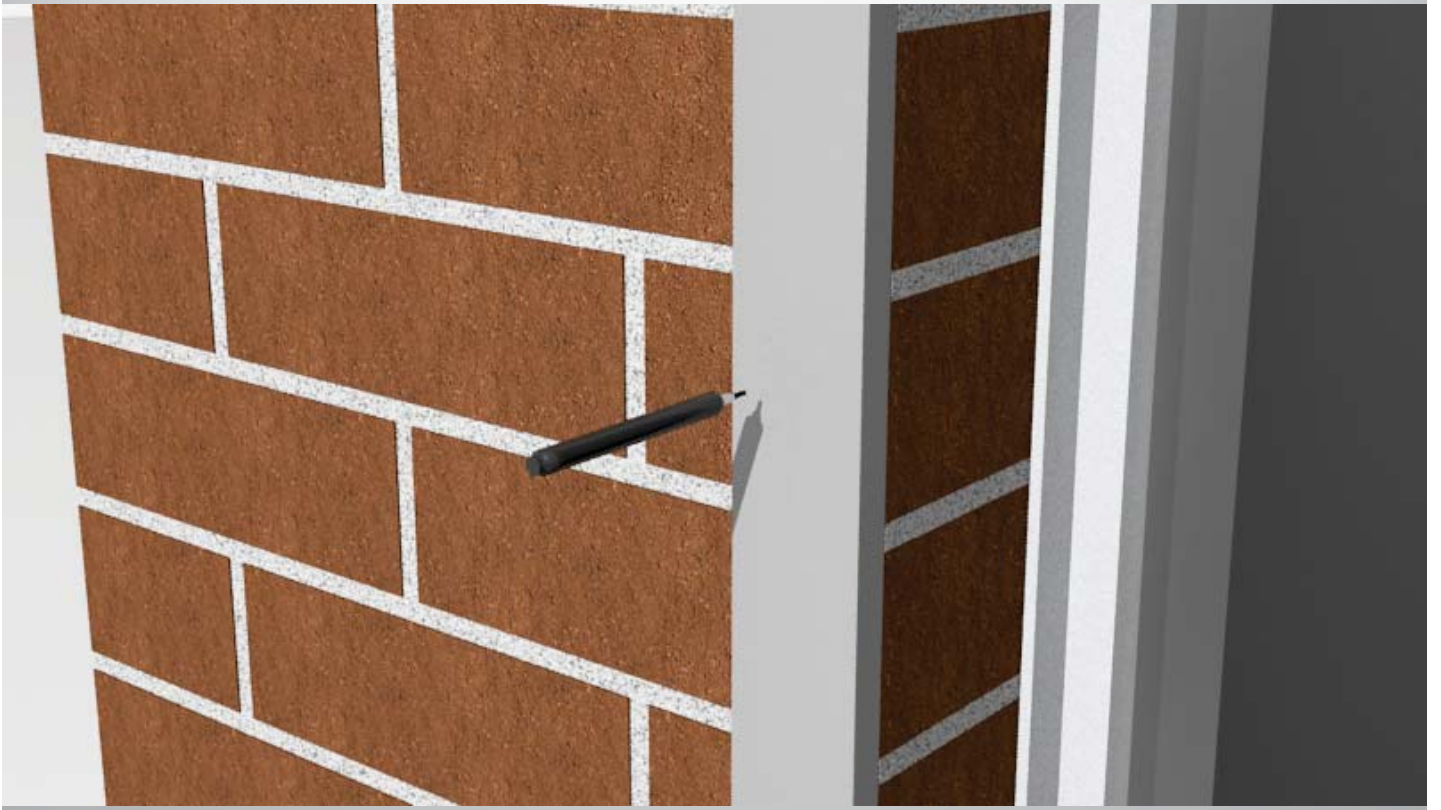

7. Mark at least 3 fixing points on the guide approx. 100 mm from the top and bottom and distribute the holes approx. 400~500 mm apart making sure you do not place the holes where the mortar is.

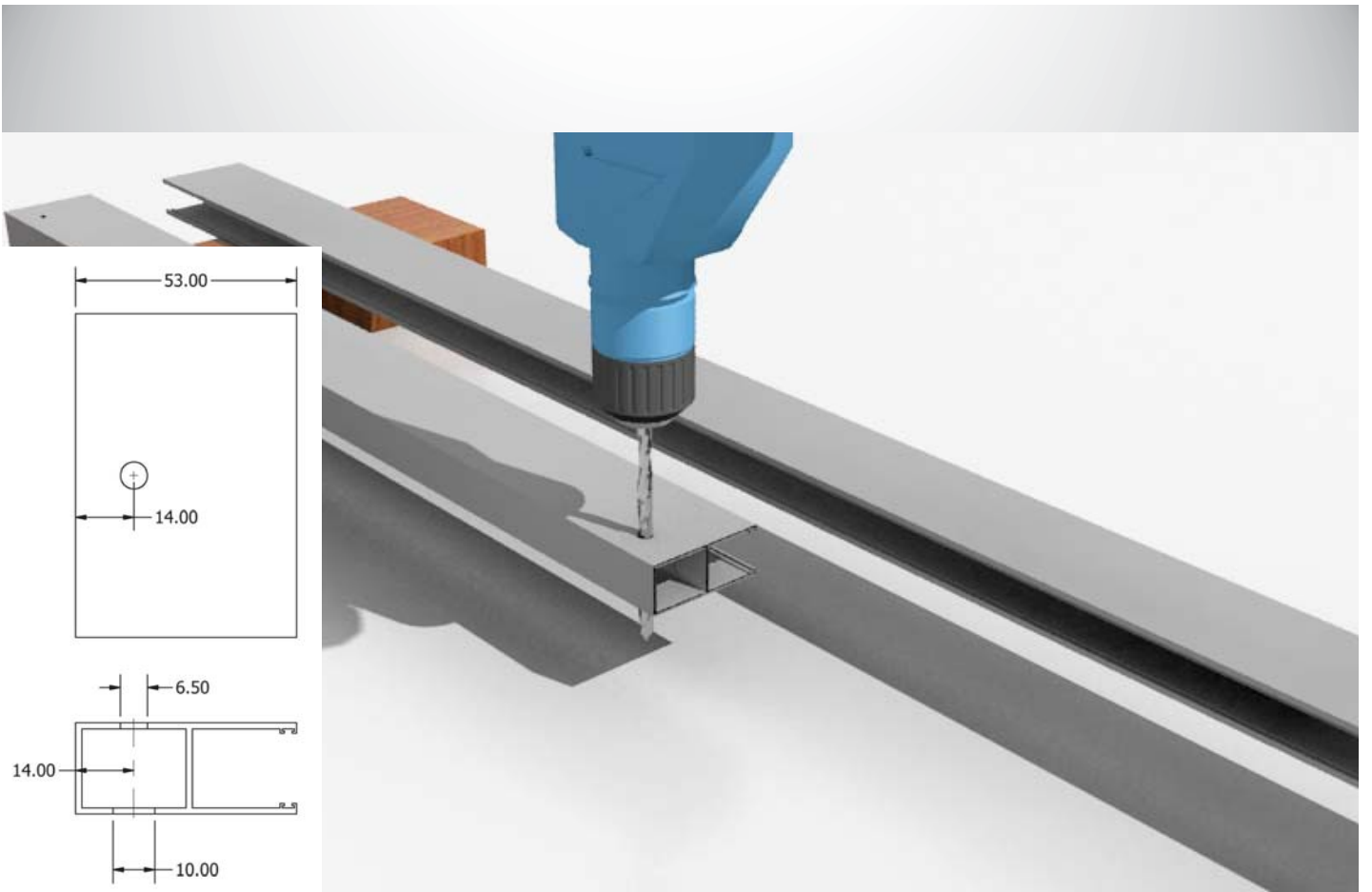

8. Put the guide back on the ground and use the 6.5 mm drill bit to drill holes all the way through on the points you have marked. Do the same on the other side's guide.

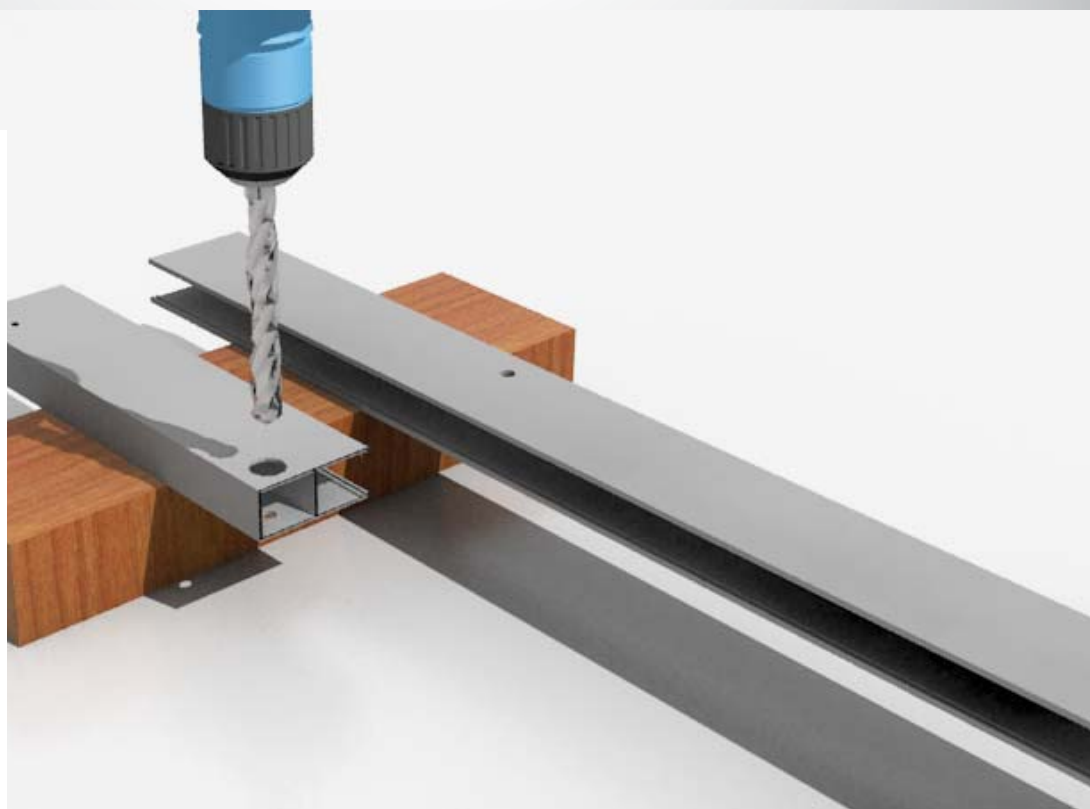
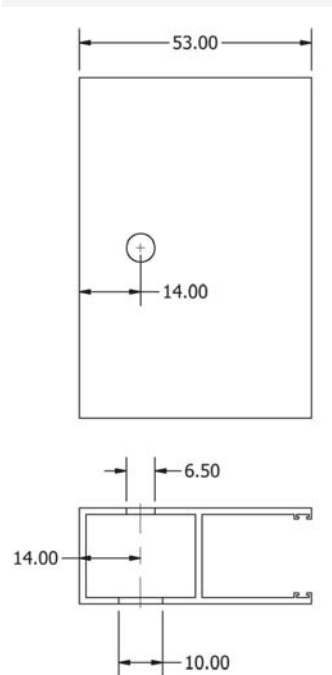

9. Then change the drill bit to 10 mm and only drill through the front part of shutter guide on all holes.



10. Put one of the guides on the wall and mark the holes on the wall.

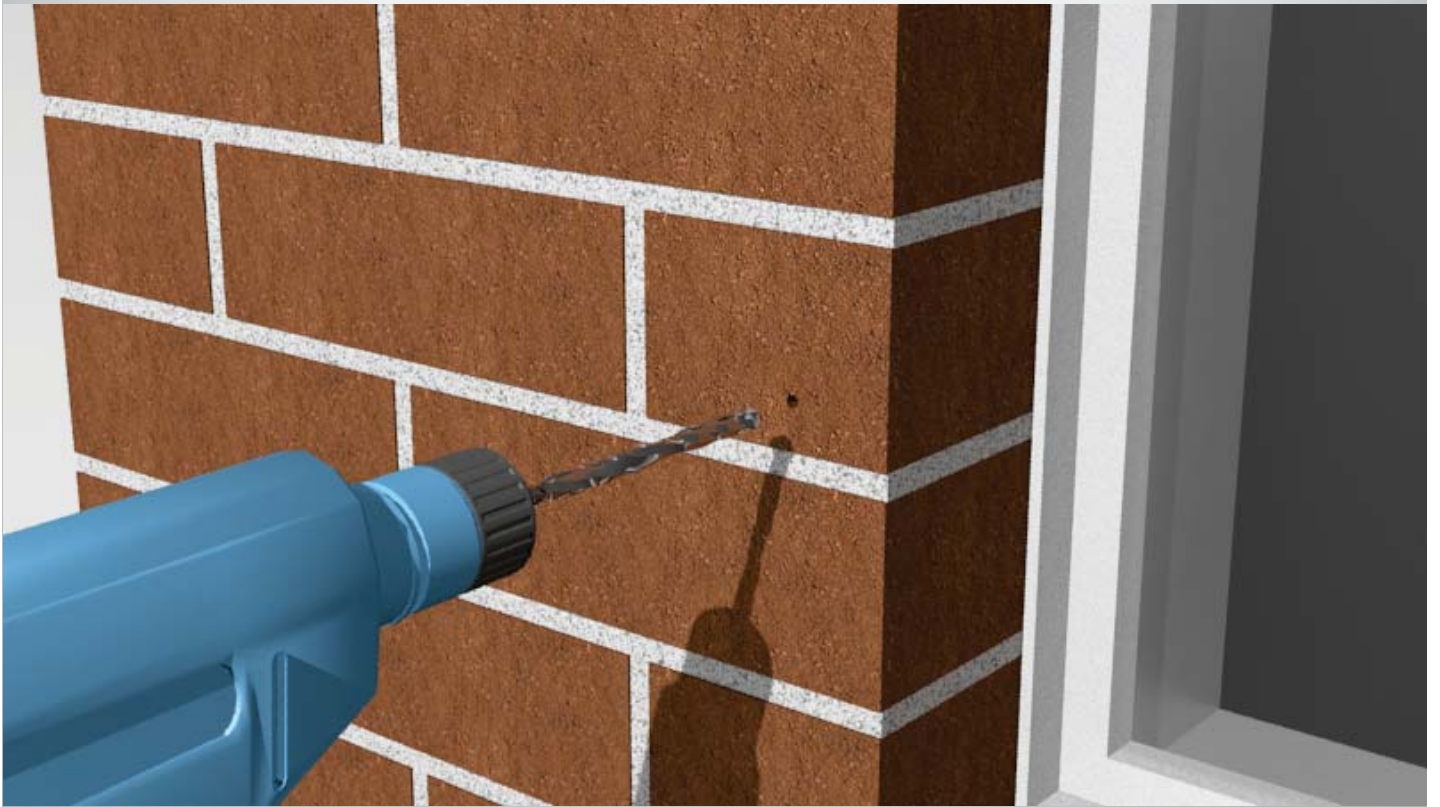

11. Use the 6.5 mm masonry drill bit to drill holes at 35 mm depth on the wall for all fixing points including the pelmet fixing point.



12. Put the wall plugs in place for fixing points.



13. Secure the guide temporarily by using just two screws at bottom and top.

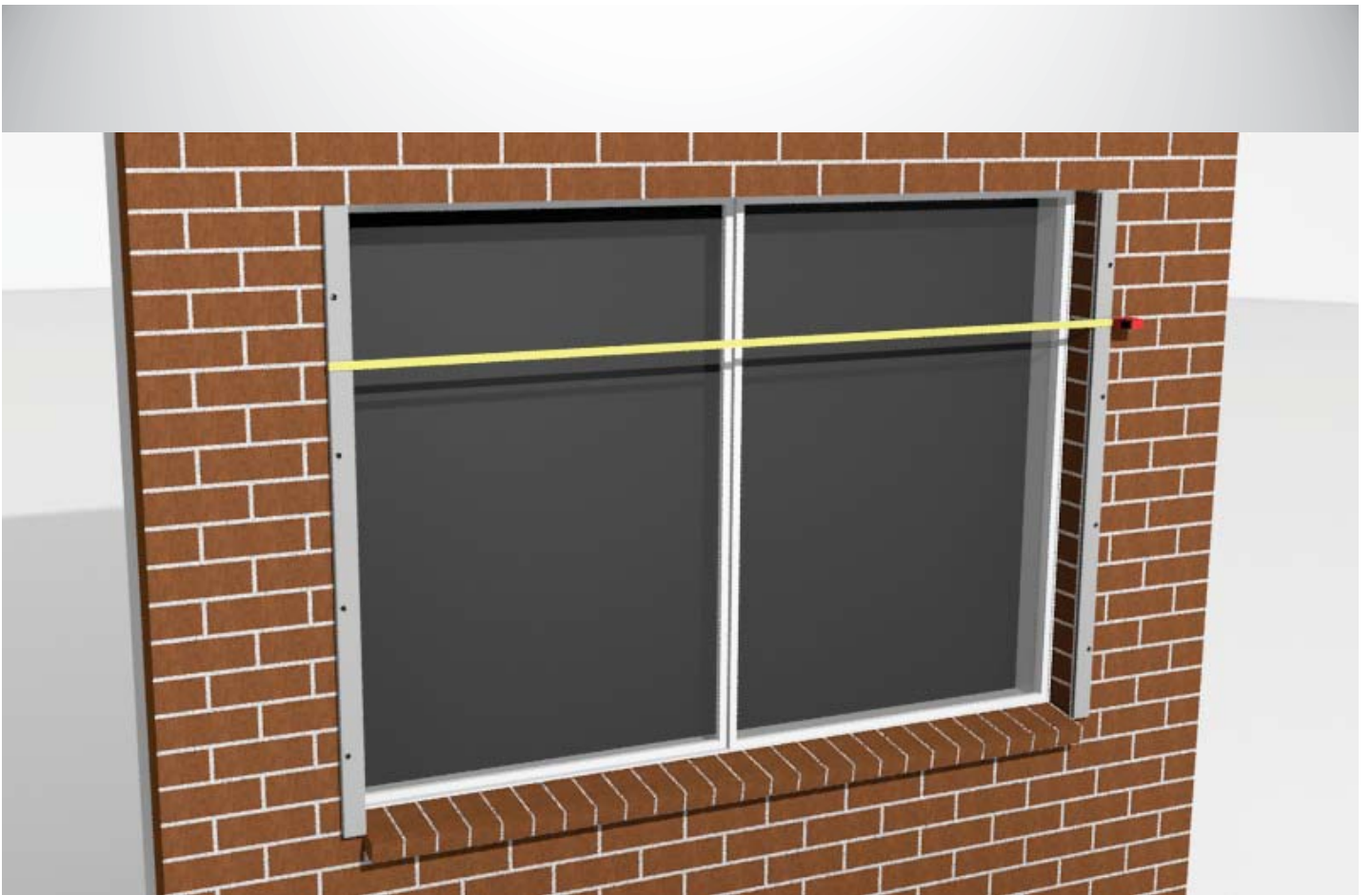

14. Put the other guide on the wall and space it so that the back to back of the guides is the same as pelmet box width. Measure the top and bottom distance to make sure the guides are parallel.



15. Use the template for the other side as well to mark the securing point for pelmet box.
Also mark the guide fixing points on the wall.



16. Use the 6.5 mm masonry drill bit to drill holes at 35 mm depth
on the wall for all fixing points including the pelmet fixing point.

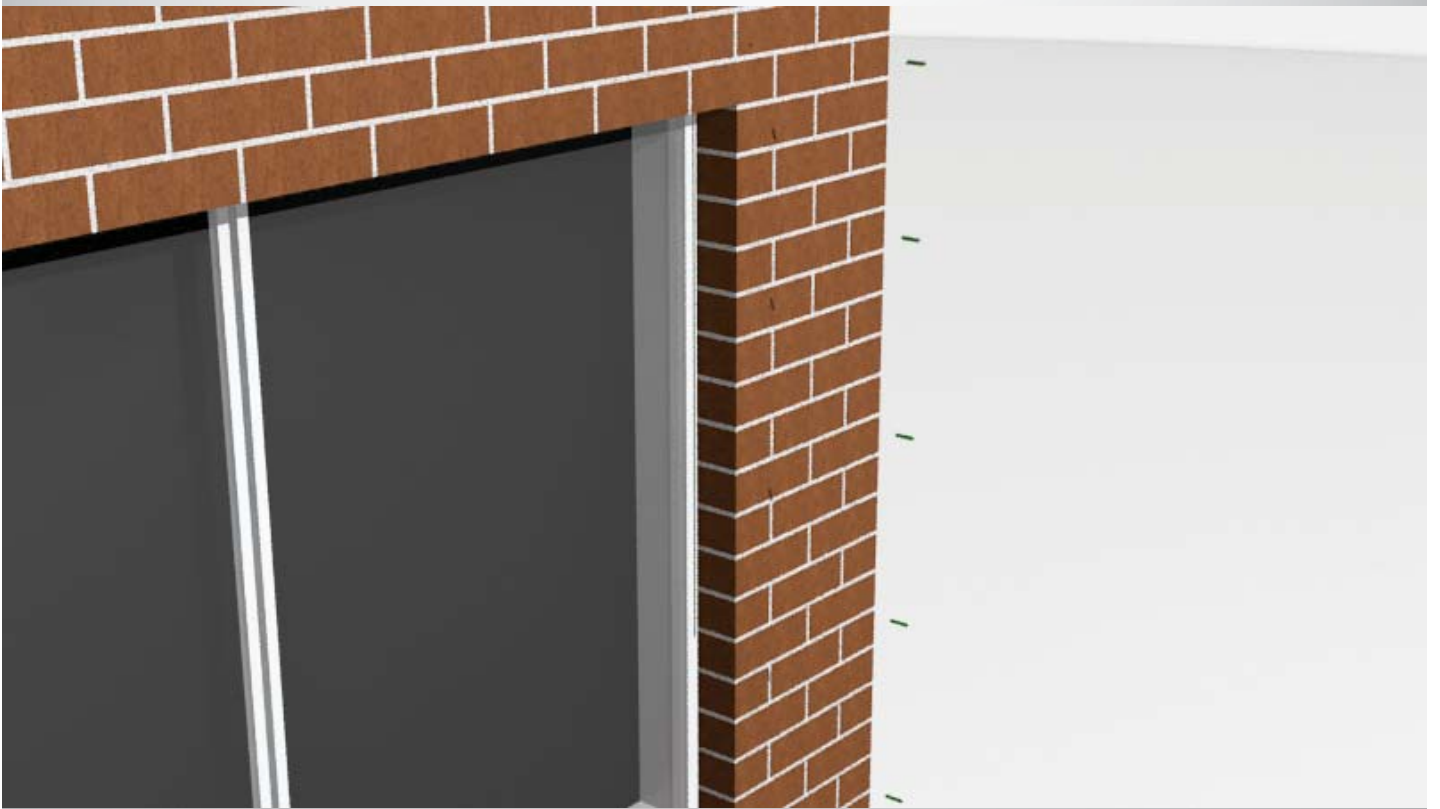

17. Put the wall plugs in place for fixing points.

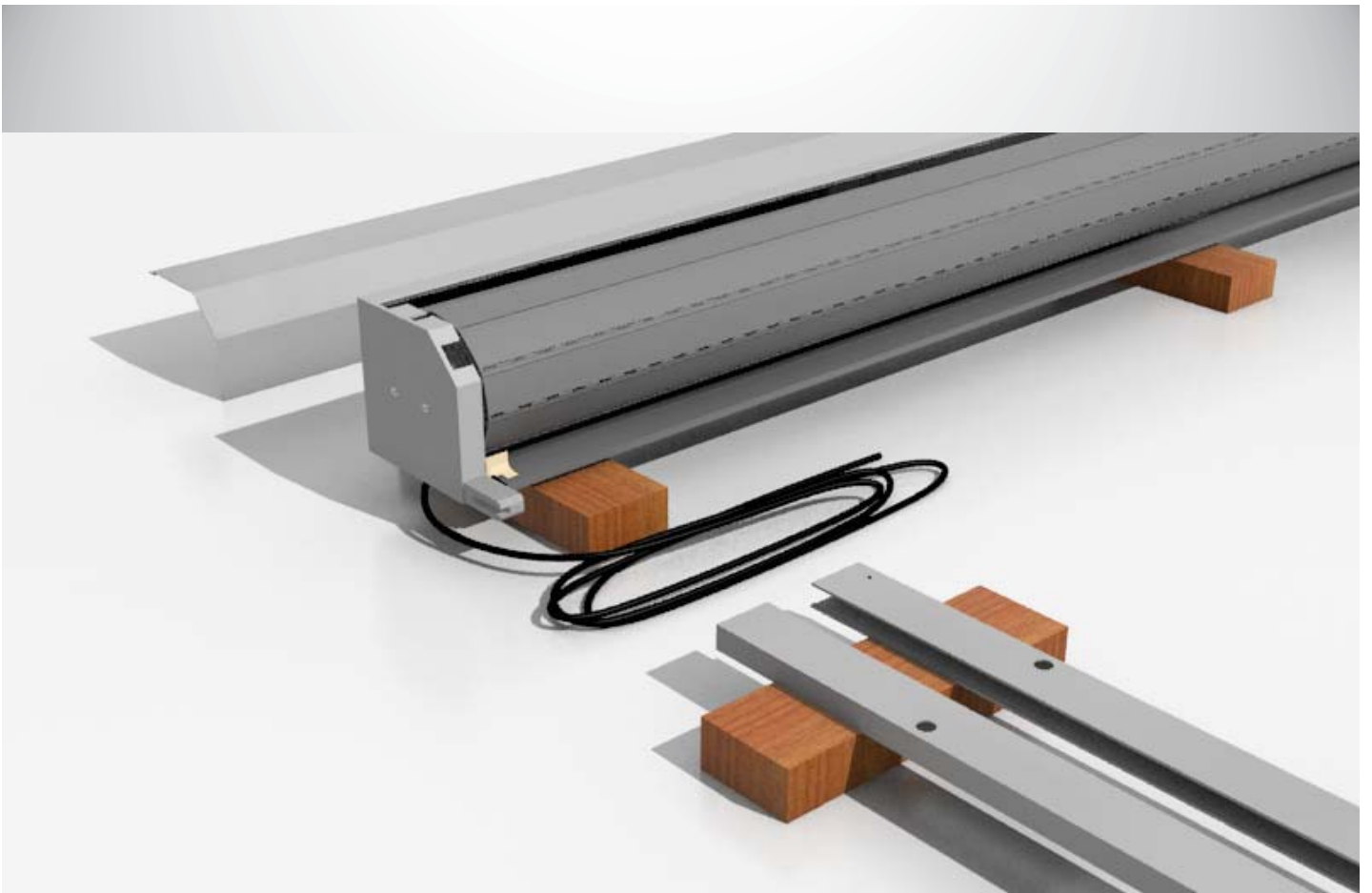

18. Unscrew and put the other guide back on the ground.

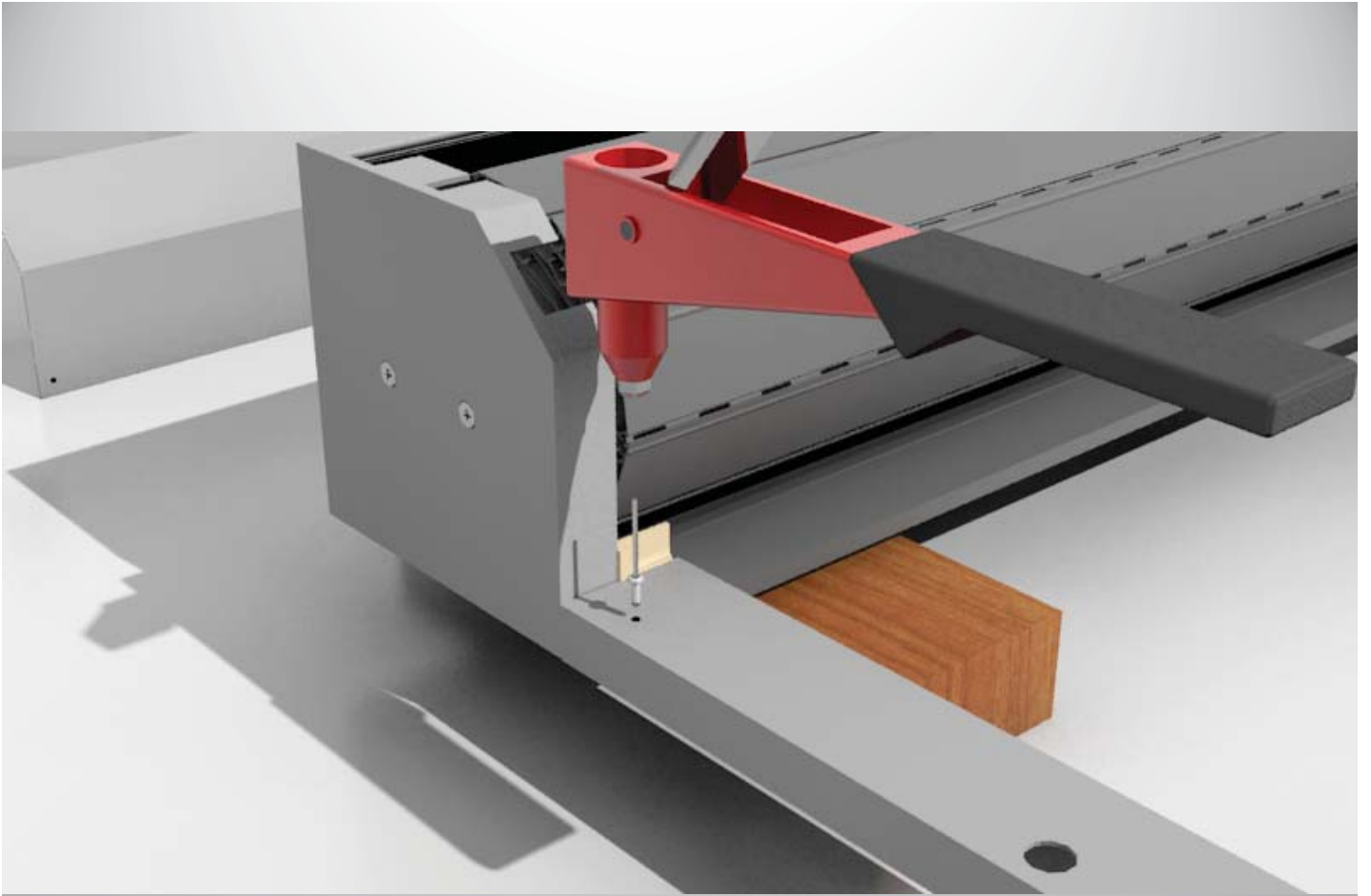

19. Slide the guides in place and secure them by rivets using the pre-drilled holes.

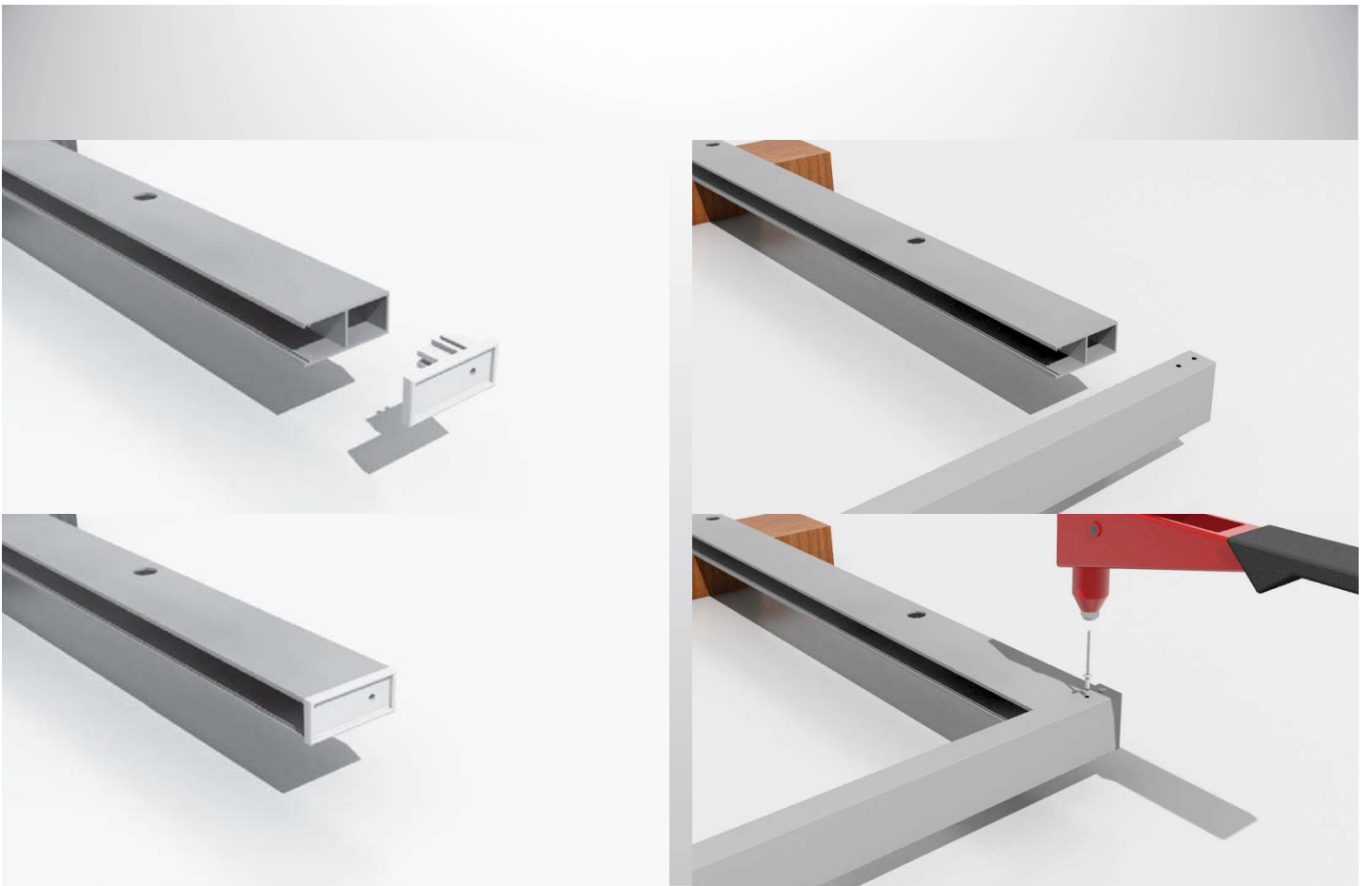

20. Slide the bottom caps in place if sill angle is not required.
If sill angle is required, secure it using rivets and pre-drilled holes.



21. Shutter is now ready to be secured on the wall.
For lifting it, put one hand underneath the pelmet box and the other holding the guide.
Avoid tilting the guides as this may break the legs.



22. For lifting the shutter, two people need to hold the assembly on both sides and lift at the same time to place it on the wall. Then slide it up in place while pushing against the wall



23. Secure the guides using the provided screws.



24. After putting all the screws in, use the plastic caps to cover the holes.

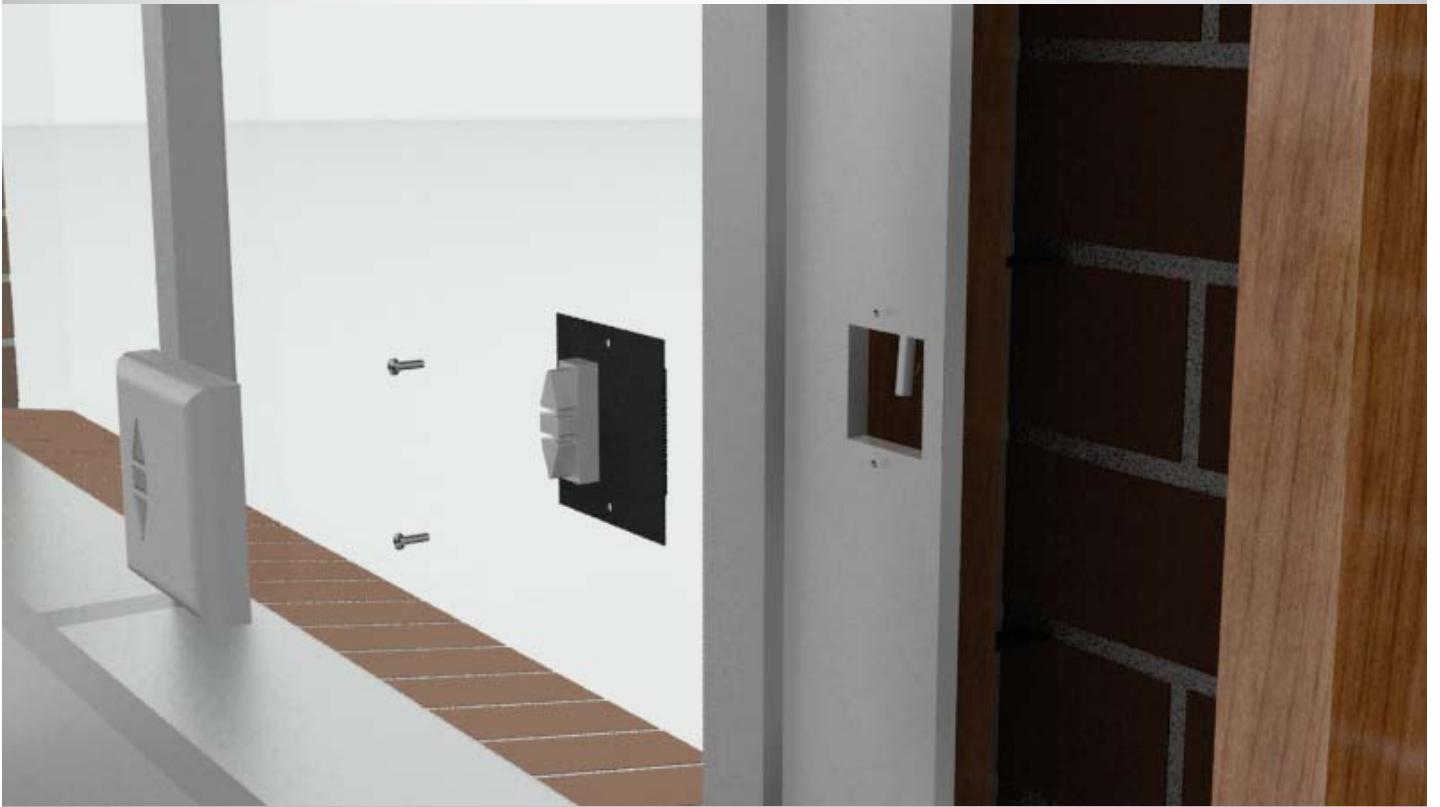

25. The roller shutter is now secured. Leave the cable in box and ask a 'Qualified Electrician' to wire the motor for you according to the instructions.



26. With the motor connected, now you can operate the shutter and unroll it.



27. With the shutter out of the way, secure the pelmet box on the wall.

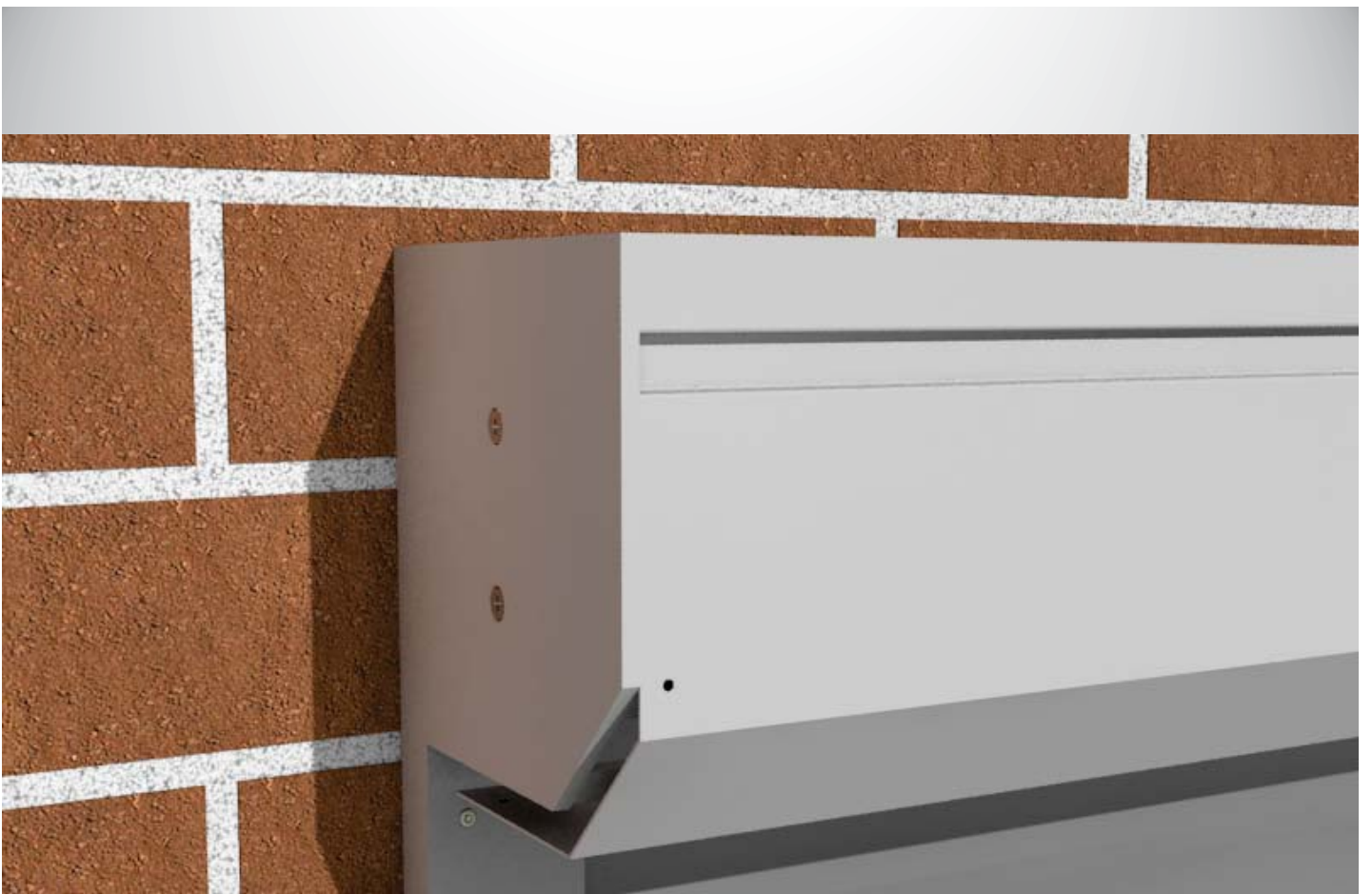

28. Put the front cover in place by sliding it in.

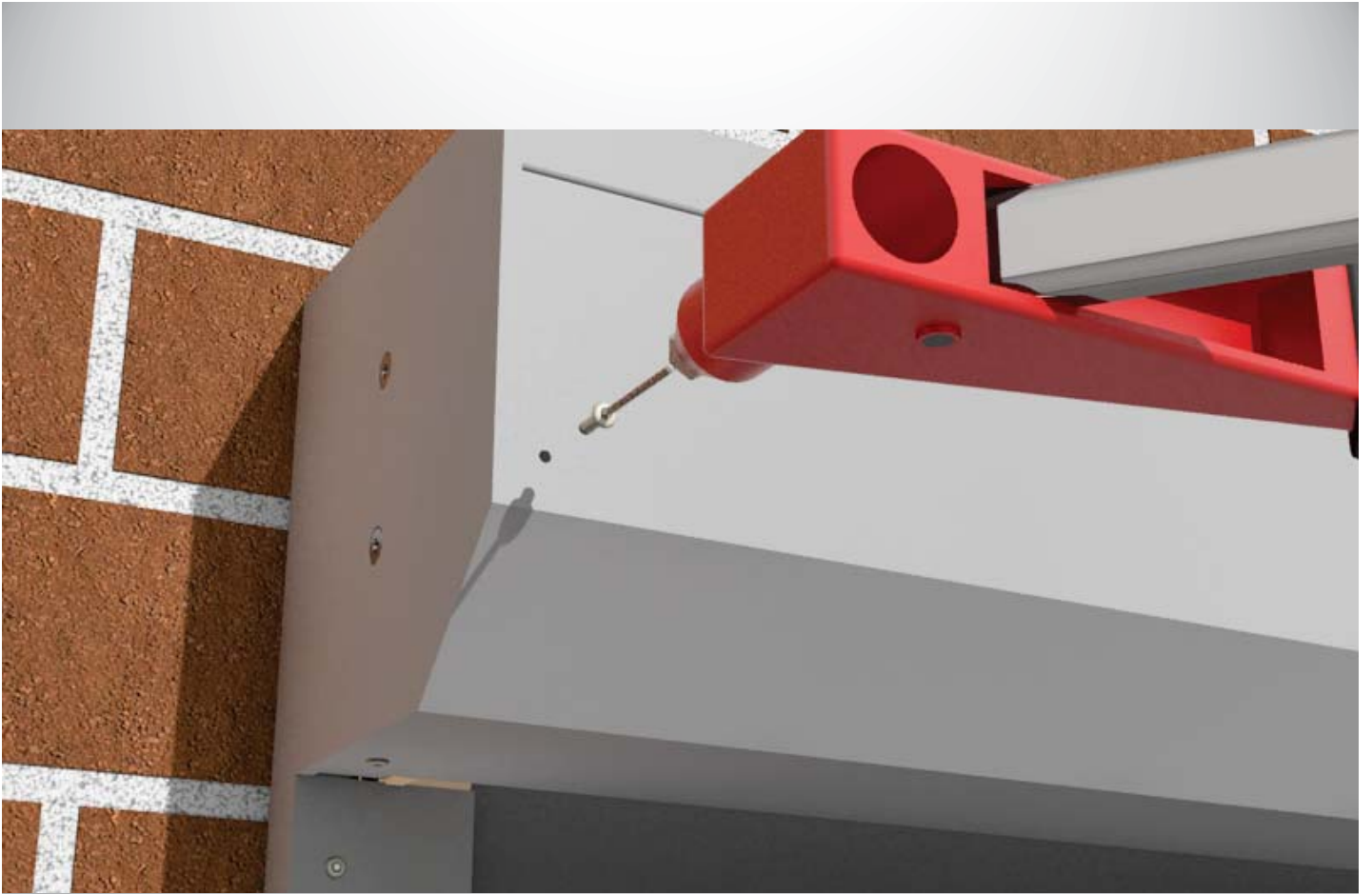

29. Then secure it by rivets using the pre-drilled holes.

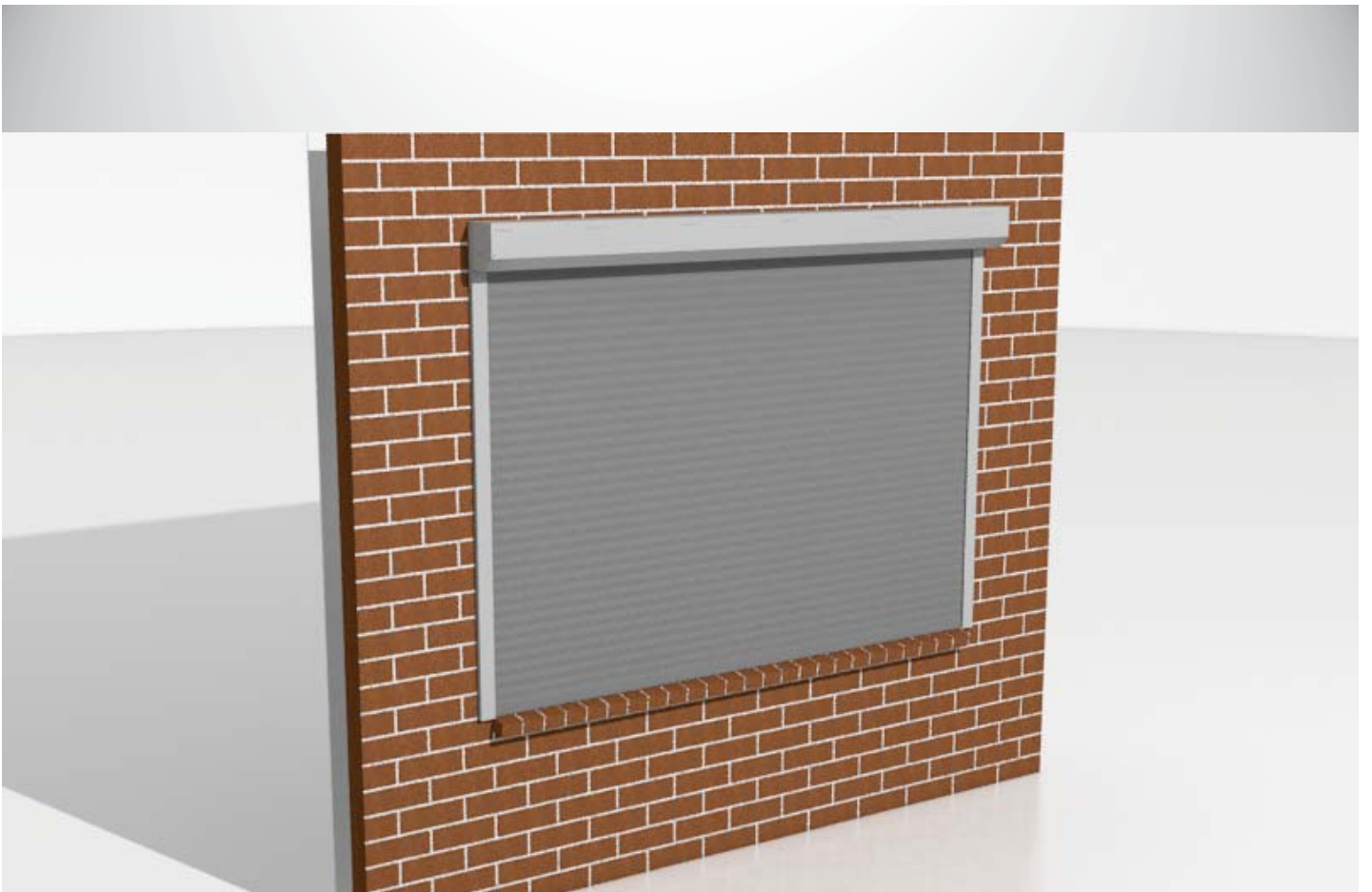

Enjoy your roller shutter!