

VICTA

Reproduction

Line Trimmer Assembly and Owner's Manual



WARNING! Read this manual before operating your VICTA trimmer.



IMPORTANT NOTES

Please read the following

Thank you for purchasing your VICTA trimmer. VICTA prides itself in the quality and performance of all its products.

This instruction manual will aid in the assembly, safe operation and maintenance of your trimmer.

Please read the following warnings to ensure safety and the long life of your product.

Safety Markings and Symbols



Warning!

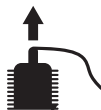

Always switch off the machine and pull off the spark plug boot



Read the directions for use before operating the machine.



Read the directions before carrying out any maintenance work.



Wear safety goggles, a helmet and ear protection.



Do not use rigid cutting disk.



Wear sturdy, non-slip footwear.



Do not use solid saw edged blades.



Wear safety gloves.

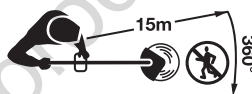

All bystanders must be kept at least 15 m from the machine.



Protect the machine from rain and damp.



Tool continues to run some seconds after switching off motor.



Be careful of objects being thrown out!









CAUTION: Hot machine parts. Keep your distance.

- Read the instructions carefully. Ensure you are familiar with all controls & safety precautions outlined in this document before operating the machine.
- Stay alert and watch what you are doing when operating the machine. Do not operate the trimmer under the influence of alcohol, drugs or medication or when you are tired or sick.
- Operate the trimmer at reasonable hours only - not early in the morning or late at night or when people might be disturbed. Check with your local council for operation times.
- Do not operate the trimmer indoors or in confined spaces.
- While the trimmer is running, always keep hands and feet away from the trimmer head. (Keep away from any bystanders or animals when in use.)
- Use only manufacturer's genuine recommended replacement parts and accessories.



Table of Contents

	Quick Start		
		Quick Start	1
	Features & Definitions		
		Features Definitions	2
	Safety & Handling		
		Safety Instructions	4
		Hazards	5
		Personal Safety Equipment	6
	Assembly Procedures		
		Handle Assembly	7
		Carry Strap Assembly	7
		Guard Assembly	7
		Shaft Assembly	8
		Trimmer Line Assembly	9
		Cutting Head Assembly	12
	Operating Instructions		
		Fuelling Procedures	13
		Starting Instructions	14
		Stopping Instructions	17
		Trimming Tips	16
	Maintenance & Care		
		Air Filter	17
		Spark Plug	18
		General Maintenance	18
		Cleaning & Storage	18
		Maintenance Chart	19
	Troubleshooting		
		Troubleshooting	20

NOTE – WARRANTY DETAILS ARE NOT WRITTEN WITHIN THIS OPERATOR'S MANUAL. REFER TO OTHER DOCUMENTS SUPPLIED WITH THIS MACHINE FOR WARRANTY DETAILS.

THE WARRANTY DOCUMENTS MAY INCLUDE TECHNICAL SPECIFICATIONS THAT ARE SPECIFIC TO EACH MODEL THAT ARE NOT WRITTEN WITHIN THIS OPERATOR'S MANUAL.



QUICK START

Quick Start Guide



Check the position & operation of controls to ensure you are comfortable before you start using the machine.



Check all components are assembled as per assembly instructions on page 7.

Check

- That there are no leaks in the fuel system
- That all screws are securely fastened
- Trimmer Bump Head, Guard and Coupling are secured safely and as instructed.

Quick Start Guide

1 – Get ready...

- Place the trimmer on a hard, level surface.
- Press the PRIMER 10 times.

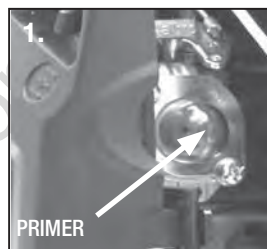

2 – Set

- Set STOP switch to the “ON” position (I)
- Set the choke lever to COLD



3 – Go!

- Slightly pull out the starter cord until you feel it resist
- Then tug sharply on the starter cord 2 or 3 times.
- Tug sharply on the starter cord as before.
- 2 or 3 pulls should start your trimmer.



Never allow the starter cord to snap back. This may damage the machine!
Repressing the throttle lever will release the throttle lock from the fixed position.

FEATURES & DEFINITIONS



Bent Shaft Trimmer

- 1 Cast Trimmer Head
- 2 Shoulder Strap
- 3 Universal Handle
- 4 Trimmer Guard
- 5 3mmØ Nylon line 20pc (Grey)
- 6 Spark Plug Wrench
- 7 Allen Key
- 8 Allen Key
- 9 Reversible Screw Driver
- 10 Hook, Shoulder Strap
- 11 Engine Stop Switch
- 12 Throttle Lever
- 13 Presence Release
- 14 Spark Plug Boot
- 15 Engine Shroud Cowling
- 16 Fuel Primer Pump
- 17 Starter Chord Lever
- 18 Choke Lever
- 19 Air Filter Housing Cover
- 20 Petrol Tank
- 21 Shaft Coupling
- 22 Trimmer Line - Bump Head
- 23 Bent Lower Shaft
- 24 Upper Shaft

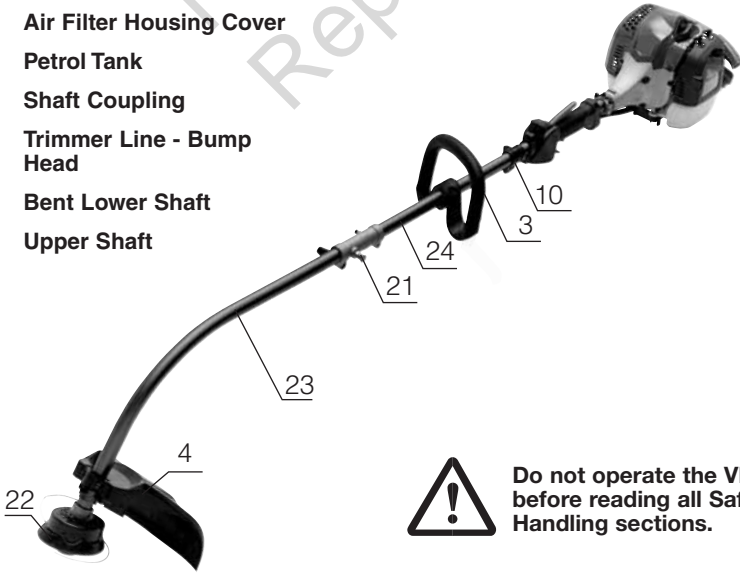
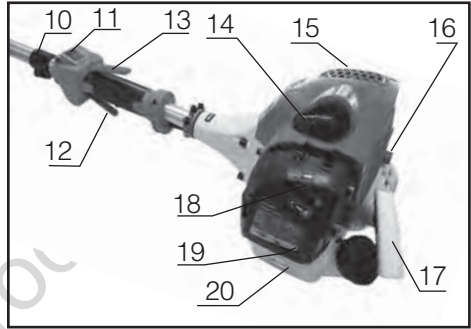

Do not operate the VICTA Trimmer before reading all Safety & Handling sections.



FEATURES & DEFINITIONS

Straight Shaft Trimmer

- 1 Cast Trimmer Head
- 2 Shoulder Strap
- 3 Universal Handle
- 4 Trimmer Guard
- 5 3mmØ Nylon line 20pc (Grey)
- 6 Spark Plug Wrench
- 7 Allen Key
- 8 Allen Key
- 9 Reversible Screw Driver
- 10 Hook, Shoulder Strap
- 11 Engine Stop Switch
- 12 Throttle Lever
- 13 Presence Release
- 14 Spark Plug Boot
- 15 Engine Shroud Cowling
- 16 Fuel Primer Pump
- 17 Starter Chord Lever
- 18 Choke Lever
- 19 Air Filter Housing Cover
- 20 Petrol Tank
- 21 Shaft Coupling
- 22 Trimmer Line - Bump Head
- 23 Straight Lower Shaft
- 24 Upper Shaft
- 25 Bracket, Trimmer Guard

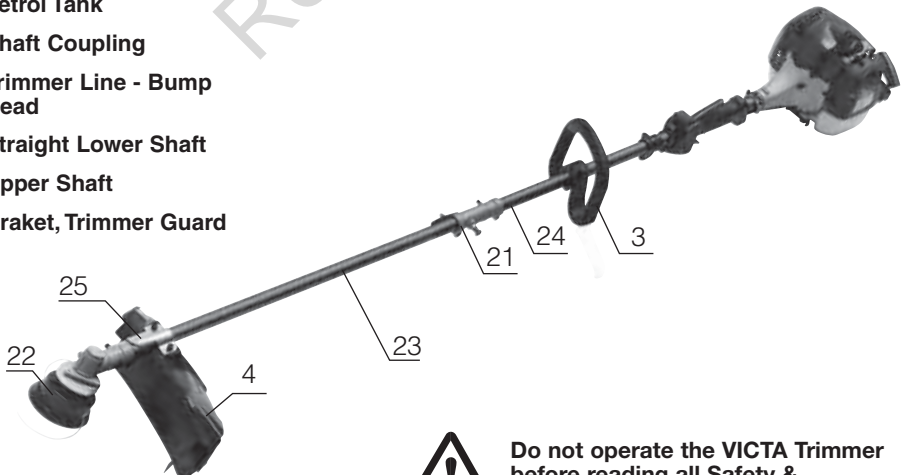
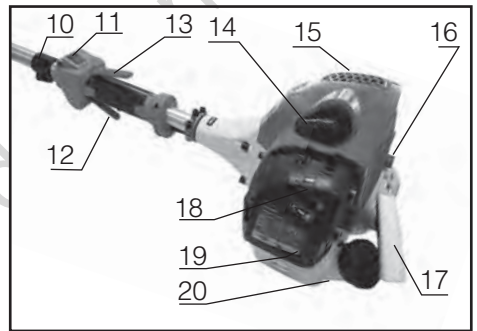
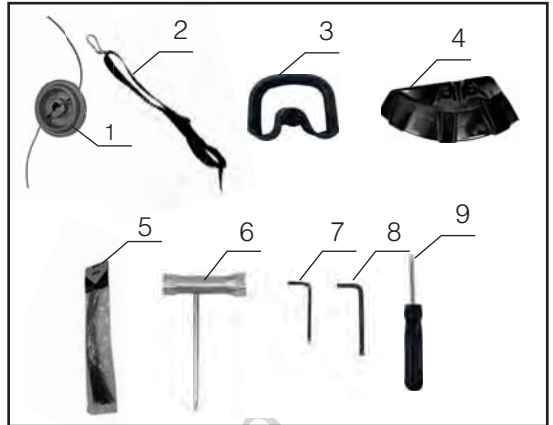

Do not operate the VICTA Trimmer before reading all Safety & Handling sections.



Safety Instructions



Do not operate the VICTA Trimmer before reading all Instructions & reading all Safety & Handling sections.

Operator Safety

- Wear the necessary safety equipment, as listed on page (6), in the Personal Safety Equipment Section.
- Always wear heavy, long pants. Do not wear loose clothing, jewellery, short pants, sandals or go barefoot. Secure hair so it is above shoulder length.
- Do not operate the unit if you are tired, ill or under the influence of alcohol, drugs or medication.

Unit Safety

- The product is intended for garden maintenance trimming of organic ground covering such as grass and lawn. The product must not be used for or modified for uses other than is intended, unless approved by the manufacturer.
- Inspect the entire unit and cutting head before each use.
- Ensure that the guard is properly attached.
- Do not use the unit if it is running erratically. Have it serviced promptly.
- Keep handles free of oil and fuel.
- Learn how to stop the engine quickly in an emergency.
- Stop the engine when the unit is unattended. Never leave engine running while unattended.
- Never allow children or unauthorised persons to operate the unit.
- Do not leave the unit on dry cuttings when it is Hot, as a risk of fire is present. Do not cover muffler or restrict airflow to muffler.

Fuel Safety

- Use a container approved for fuel and a funnel to avoid spillage.
- Mix and pour fuel outdoors where there are no sparks or flames.
- Frequently check for fuel leaks.
- Do not smoke or allow smoking near fuel, or near the unit, or while using the unit.
- Add fuel before starting the unit.
- Never remove the fuel tank cap while the engine is running or hot, allow to cool before refuelling.
- Never allow the unit to run out of fuel before refuelling.
- Move at least 3 metres away from the fuelling site before starting the engine.
- Wipe all traces of fuel on the unit before starting the engine.
- Change your clothes before starting the unit if fuel has been spilt on them.



SAFETY & HANDLING

Safety Instructions

Starting Safety

- Start the engine with feet well away from the cutting head.
- Ensure that the area of starting and operation is clear of sticks, stones, glass, nails, wire, string and debris, which could be thrown by the cutting head.

Cutting Safety

- Use only in good visibility and favourable weather conditions.
- Keep children, animals and bystanders outside the 15 metre hazard zone. Stop the engine immediately if approached.

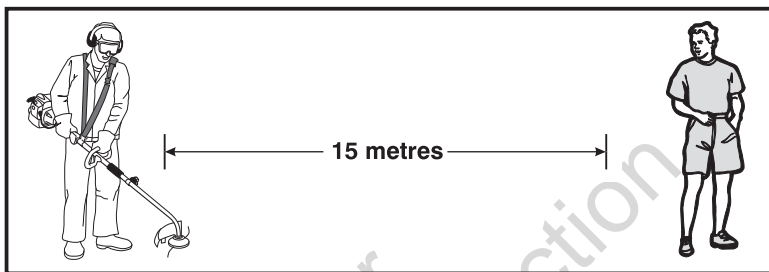

- Keep the engine to the right of your body, holding the unit with both hands.
- Keep a firm footing and balance. Do not over reach.
- Keep the cutting head below waist level and do not raise the engine above your shoulder. The cutting head can come dangerously close to your body.
- Keep your body away from the cutting head and muffler when the unit is running.
- Do not strike objects that may cause harm or damage to the unit.

Maintenance Safety

- Stop the engine and disconnect the spark plug before clearing blockages, checking or working on the unit. Clean carbon from the muffler at exhaust outlet frequently.
- Stop the engine, disconnect the spark plug and inspect the unit if it begins to vibrate abnormally or if it strikes a foreign object.
- Use only genuine VICTA trimmer line. Never use wire, rope, string, etc.
- Use only genuine VICTA replacement parts.

Transporting and Storage

- Hand carry the unit with the engine stopped and the muffler away from your body.
- Allow the engine to cool, empty the fuel tank and secure the unit before storing or transporting in a vehicle.
- Empty the fuel tank after each use and before storing the unit.
- Store the unit and fuel well away from sparks or open flames from water heaters, electric motors, switches or furnaces, etc.
- Store the unit out of reach of children and unauthorised persons.



Safety I Hazards

The following safety precautions must be strictly observed to avoid the risk of damage or personal injury.



Prior to using the unit, clear the operating area of objects which may be thrown up by the cutting head, such as rocks, glass and other debris.



Do not start or operate the unit inside a closed room or building. Breathing exhaust fumes can kill.



Be careful when operating the unit on slippery ground or overgrown terrain. Be attentive for concealed hazards, such as ditches, tree stumps and roots.



Maintain solid footing and balance while operating the unit. Cut only on ground level.



Never use the unit without the guard securely in place.



Do not touch the cutting head in motion. When handling blade for assembly or maintenance tasks, always wear protective gloves.



Bystanders must be at least 15 metres away during operation of the unit, as rocks and other materials may be thrown at high velocities. Switch the unit off immediately if approached.



Keep body away from hot muffler parts.

Personal Safety Equipment

Always use the following safety equipment when working with your trimmer:

- A safety helmet fitted with a visor or suitable eye protection.
- A set of ear muffs.
- A pair of protective gloves.
- A pair of safety boots.





ASSEMBLY PROCEDURES

Handle Assembly

Fitting the handle

1. Remove all the screws from the handle. (Fig.1)
2. Position brackets on Upper Shaft and secure screws.(Fig.2)
3. Position Top handle onto bracket and secure two screws. (Fig.3)

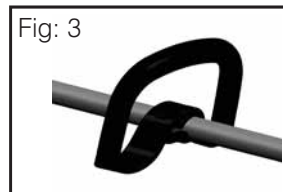
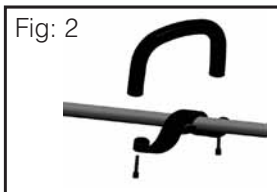
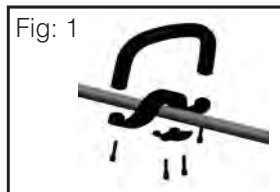

CAUTION! Not too loose or too tight. Over tightening may damage the unit.

Carry Strap Harness Assembly

Fitting the Carrying Strap Harness

- The strap is intended to help you work safely & ergonomically with the machine.
- Hook the strap into the fastening eyelet.
- Slip the strap over the shoulder.
- Set the length of the shoulder strap in such a way that the trimmer head runs parallel to the ground. In order to establish the optimum length of the strap, you should then make a few swinging movements to check operating comfort before starting the engine.

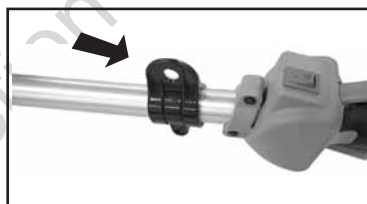

Guard Assembly

Fitting the bent shaft guard

1. Remove screw from guard using an Allen key (Fig 4).
2. Clip the guard to the lower bent shaft head spindle and ensure is seated in location (Fig 5).
3. Screw the guard hood tightly in position with the fastening screw (Fig 6).

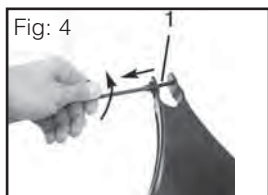

CAUTION! Do not use the trimmer without the guard.



Guard Assembly

Fitting the straight shaft guard

1. Remove two screws from guard (Fig 7).
2. Position guard under the securing saddle (Fig 8).
3. Secure the two screws into the guard (Fig 9).

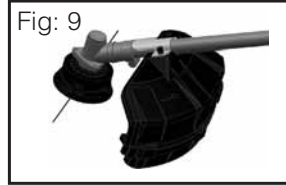
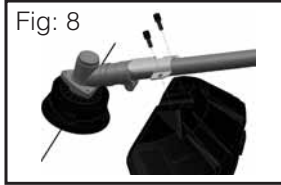

CAUTION! Do not use the trimmer without the guard.

Shaft Assembly (Split Shaft Models only)

Assembling the split shaft

1. Loosen the knob (1) on the split shaft coupling (3). (see Fig.10)
2. Then pull the pin (2) on the shaft split coupling (3) & carefully slide the lower shaft(4) into the shaft split coupling (3). (see Fig.11)

Note: When inserting shaft into the split connection, shifting of the shaft alignment by slight rotation of the cutting head may assist with smoother engagement.

3. Ensure that the pin (2) on the shaft split coupling locks into the corresponding hole (5). (see Fig.2)

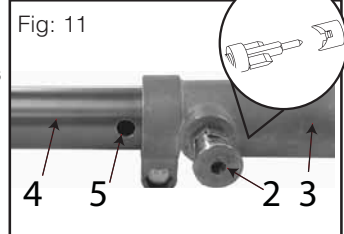
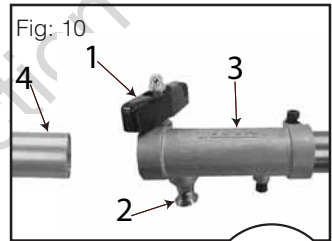

Locking the pin (2) into the shaft hole (5) ensures full engagement of drive shafts. Failure to fully engage drive shafts will damage the connection & void product warranty. (Fig.11).

4. Then firmly re tighten the knob (1). (see Fig.12)
5. To disassembly, reverse order of assembly.



Do not Start or Run engine without shafts & guards fully assembled.

Take care when fitting & tightening. Beware of pinch points.



ASSEMBLY PROCEDURES

Trimmer Line Assembly - Bump Head (Select Models only)

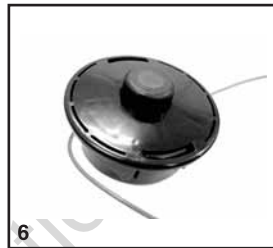
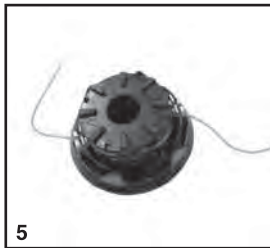
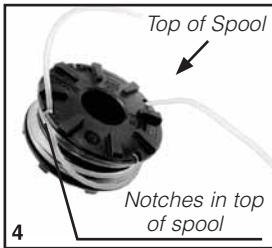
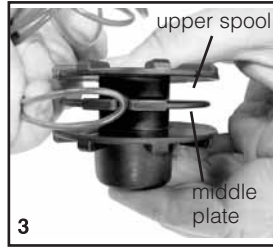
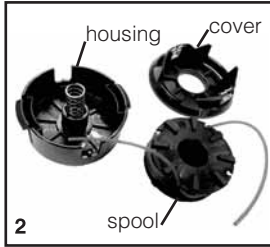

1. Press two cover clips inwards on the housing & remove the cover slowly.
Note: Retain the spring within the housing.
2. Remove the remains of worn line from the spool (if any remains).
Note: Remaining line may be sufficient to rewind and reuse if has been tangled or has retracted back into the housing.
Note: Ensure inside of housing and spool are clean and free of grass & soil before refilling.
3. Use 6 meters of diameter 2.4mm nylon line*. Fold the full length of line in the center and insert the centre fold into one of the slots in the spool middle plate.
4. Wind the upper half of the line tightly **CLOCKWISE** onto the upper spool.
Note: ' CLOCKWISE ' direction when looking at the top of the spool as shown by the arrow in Fig.4.
Continue winding until approximately 10cm remains at the end of the line and hold line end by locking into one of the four notches on the top of the spool.
Repeat process with other half of the line winding in the **SAME DIRECTION** on the lower spool and hold the line end in an opposite notch.
5. Put the spool back into the cover. Remove one end of the line from the spool notch & push it into an Eyelet slot. Repeat for the other end of the line into the opposing Eyelet slot. Pull both ends of line tightly through the eyelets to remove any excess slack in spool winding.
6. Push the spool and cover back into the housing so that the housing clips align with the cover and clicks back into place.

* 2.4mm \varnothing nylon line is recommended to provides best performance. The bump head can be fitted with line diameters from 2mm to 3mm. The maximum length of the line that can fit the head varies according to the line diameter. The maximum length capacity using 2.4mm \varnothing is 6 metres. Do not overfill the head spool with excessive lengths of line as it will result in ineffective spool feeding of line.



Trimmer Line Assembly - Bump Head (Select Models only)

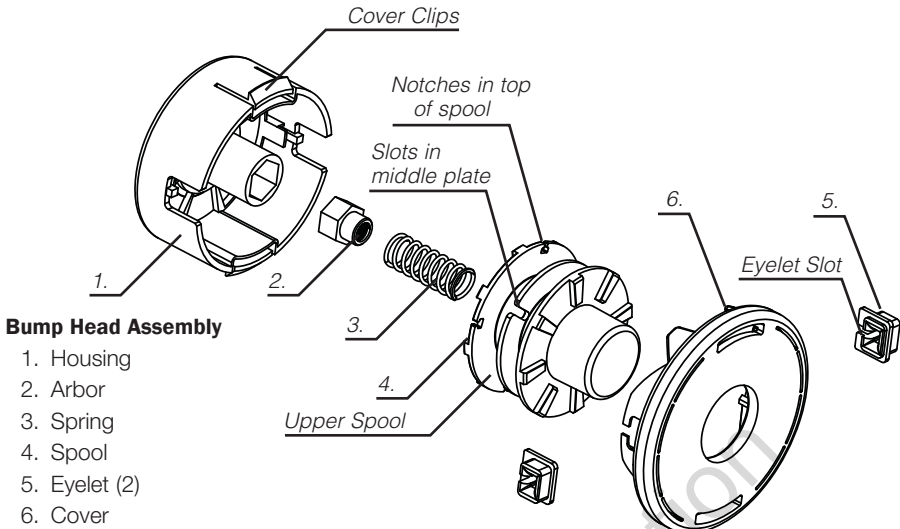

Bump Head Assembly

1. Housing
2. Arbor
3. Spring
4. Spool
5. Eyelet (2)
6. Cover

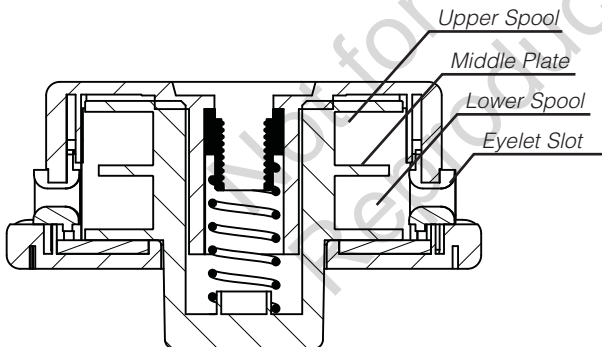

Follow the Operating Instructions on page (19) to adjust the length of the line.



Nylon line will deteriorate over time and may require replacement if line breakages and cut performance is not satisfactory

Do not operate the bump head with parts missing such as the spring or eyelets



Do not operate the bump head if the cover is not secured by the Cover Clips.

Do not operate the bump head if components are damaged or excessively worn.



ASSEMBLY PROCEDURES

Trimmer Line Assembly - Cast Alloy Head

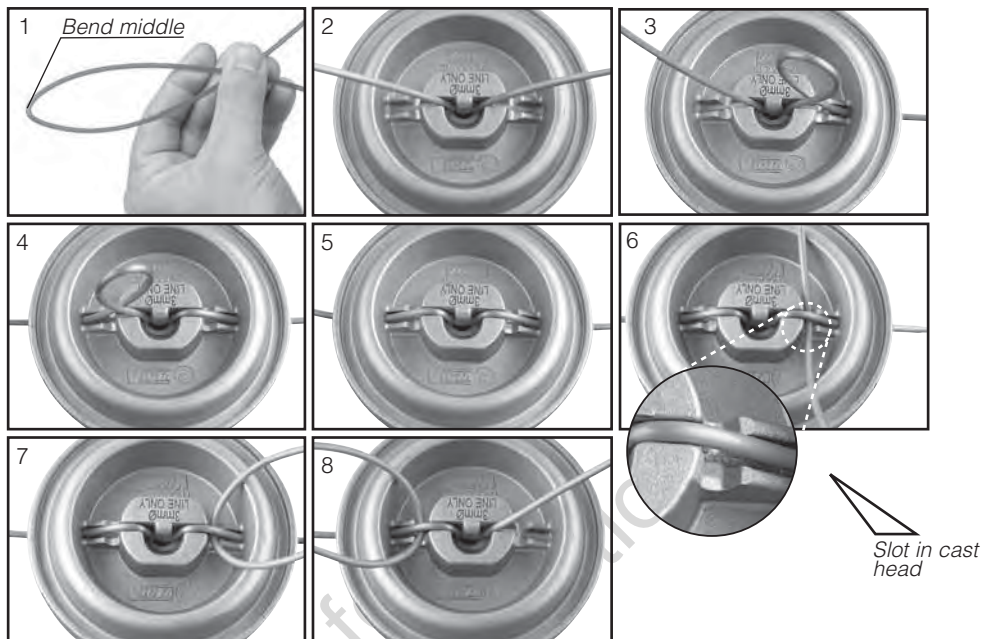

1. Cut a length of line to 44cm, or use VICTA part number TR00200A. Bend line in half at the centre (equal ends). **Use only 3mm diameter Nylon line** (Fig: 1)
2. Push the bent end of the line under the lug of the trimmer head
3. Push one end of the line into the hole on the same side of the head as the line end. Pull the line through the hole until loops or slack between the hole centre lug is removed.
4. Repeat step 3 for opposite side.
5. Refer to image for correct complete assembly of the nylon line into the head.
6. To remove used line, bend new line as in (1), slide new line under used line through slot in cast head.
7. Holding both ends of the new line together, pull the old line out of the cast head. Repeat process for the other side (8).



Only use genuine VICTA 3mm diameter nylon trimmer line in the Cast Alloy Head.

Unequal lengths of line, or mounting of line "off-centre" will cause vibration & damage to unit.



Excessive trimmer line length will damage guard and clutch or tangle in head gearbox. Do not fill head with excessive length line longer than limits of the guards.



Replace line when worn to approx 50mm from trimmer head body. Remove line by pushing length back into head or by levering out from centre.

Nylon line will deteriorate over time and may require replacement if line breakages, line wear & cut performance is not satisfactory



Cutting Head Assembly

Note: Some models are supplied with cutting head options which can be changed as preferred. Some models are supplied with a head removal spanner to assist with removal of the Cast Alloy head.

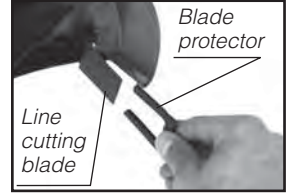

Always ensure the line cutting blade on the guard is covered with the blade protector when fitting, changing or removing the trimmer head. Always disconnect the spark plug lead before and work is done on the trimmer. Never operate the machine without a cutting head fitted. Never fit an alternative cutting head that has not been recommended by the manufacturer.

HEAD REMOVAL & REPLACEMENT

BENT/CURVED SHAFT CUTTING HEAD

1. Replace blade protector.
2. Align hole in Mounting Washer & slot in spindle.
3. Insert Allen Key into hole & firmly support to lock shaft rotation.
4. Grip the head & rotate **anti-clockwise** to remove.
5. Refit preferred head in reverse order & firmly tighten.

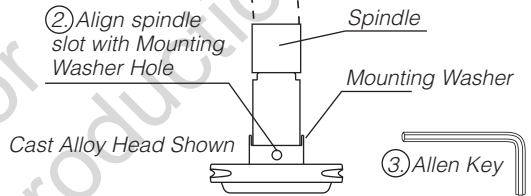

STRAIGHT SHAFT CUTTING HEAD

1. Replace blade protector.
2. Align hole in Mounting Washer and Gearbox slot.
3. Insert Allen Key through hole in Gearbox Flange, through hole in Mounting Washer and into gearbox slot. Firmly support Allen key to lock shaft rotation.
4. Grip the head & rotate **clockwise** to remove.
5. Refit preferred head in reverse order & firmly tighten.

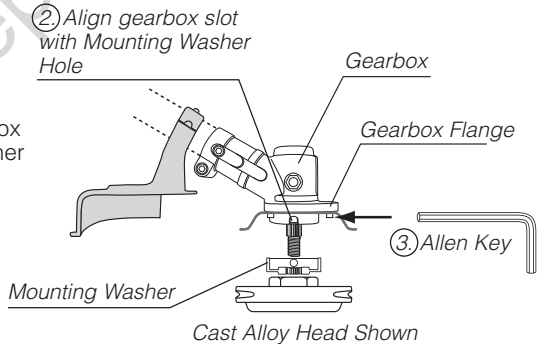

NOTE: Not firmly supporting alignment locking of shaft with the Allen Key may cause damage to the Gearbox or Mounting Washer.



It is important to note the direction of rotation to tighten/remove heads & to avoid over-tightening or damage to the Gearbox, Spindle or mounting thread.

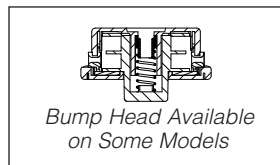



OPERATING INSTRUCTIONS

Before Starting



Check the position & operation of controls to ensure you are comfortable before you start using the machine. Triggers, starter cord and grip position should provide smooth operation, balance and comfort before starting the machine. Check that all screws are securely fastened and also check all the safety devices.



Always use the shoulder strap when using the machine. Switch off the engine before you take off the shoulder strap.

Check the machine for the following each time before use:

- That there are no leaks in the fuel system
- That the cutting unit and all safety devices are in perfect condition
- That all screws are securely fastened

Fuel and Oil

Recommended fuels

- Use only a mixture of normal unleaded petrol and 2-stroke engine oil. Mix the fuel mixture as indicated on the fuel mixing table.
- Start the machine at least 3 metre away from the refuelling site to avoid the possible risk of fire.
- Do not smoke whilst refuelling or working with the machine.
- Do not use the trimmer near inflammable liquids or gases. This could result in an explosion and/or fire.
- Pour the correct quantities of petrol and 2-stroke oil into a container. Then shake the container well.

NOTE: Product may need to be reprimed if it has run out of fuel.



- **Victa recommends the use of Victa Formula V 2-stroke oil at 50:1 fuel to oil ratio only.**
- **The use of other oils and or ratios will affect the engine lubrication, which may cause engine damage and void engine manufacturer's warranty.**
- **Do not use a fuel mixture which has been kept for longer than 90 days, it may damage the unit.**
- **Only use containers designed and approved for the purpose to transport and store fuel.**

Fuel Mixture Table

Petrol (unleaded)	2-stroke oil
5 litre	100 ml (Only for Victa Formula V 2-stroke Oil)
Mixing procedure: 50 parts unleaded petrol to 1 part 2-stroke oil	
USE Clean fresh "Regular Unleaded Fuel" Fuel with up to 10% ethanol can be used	



Starting the Engine

Cold Start

- (1) Set the machine down on a hard, level surface
 - (2) Press the fuel pump primer 10 times
(This is found behind the air filter housing - see Fig 1.)
 - (3) Ensure the 'STOP SWITCH' is set to the 'ON' position
(slide back towards the engine) as shown in Fig 2.
 - (4) Secure the throttle lever as follows
 - a. Press the presence control(1)
 - b. Press throttle lever (2)
 - Let go of the throttle release & throttle lever.
 - (5) Set the choke lever to the 'COLD' position, (see Fig 3.)
 - (6) Pull out the starter cord until you feel it start to resist.
Then tug sharply on the starter cord 2 or 3 times or until the engine tries to start.
- ★ The engine may start or run for a short period set on cold.
Choke can be set to hot while the engine is running.
- The Choke lever should be in Hot Position. (see Fig 4.)
 - If required, tug sharply on the starter cord 2 or 3 times or until the engine starts.
- ★ ★ In cold conditions, the engine may require 5-10 seconds running at idle. Slight intermittent pulling of the trigger may assist during engine warm-up.
- If the engine fails to start, repeat the process from step (4)

Note: Adjustment of the choke lever between "HOT" and "COLD" position may be required during engine warm-up. Engine warm-up may take several minutes until the engine is running hot and engine speed is stable.

If the engine slows down or stops, adjusting the choke lever towards the "COLD" position may be required during warm-up. Return the choke lever to the "HOT" position, before proceeding with operating the machine.

Hot Start

- (1) Set the machine down on a hard, level surface
- (2) Ensure the 'STOP SWITCH' is set to the 'ON' position
(slide back towards the engine) as shown in Fig.3.
- (3) Secure the throttle lever as follows
 - a. Press the presence control(1)
 - b. Press throttle lever (2)
 - Let go of the throttle release & throttle lever.
- (4) Ensure the choke lever is set to the HOT position, (RED see fig 4)
- (5) Pull out the starter cord until you feel it start to resist.
Then tug sharply on the starter cord 2 or 3 times or until the engine starts.
- If the engine fails to start, retry the "COLD" start Procedure or refer to the trouble-shooting section.

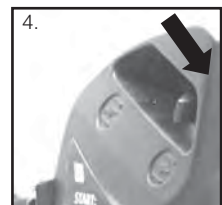
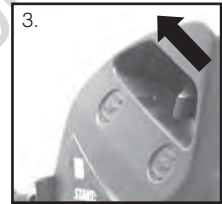
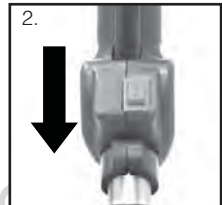
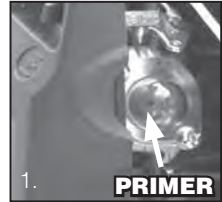



OPERATING INSTRUCTIONS

Starting the Engine



If the engine does not start up after several attempts, read the section on trouble shooting.



Always pull the starter out in a straight line.
IF THIS IS NOT FOLLOWED, STARTER CORD WILL BE FRAYED AND CORD WILL BREAK!
This is not covered by the product Warranty.

Switching Off the Engine

Emergency Stop procedure

- If it becomes necessary to stop the machine immediately. Let go of the throttle lever and move the stop switch to 'OFF'.
- Note the switch will need to be returned to the 'ON' position prior to restarting.

Feeding Bump Head Line

To increase the length of nylon trimming line when using the Bump Head;

1. Run the trimmer at maximum RPM while firmly bumping the spool on the ground.
2. The line will come out incrementally each time head is bumped.
3. Check the length after each bumping and repeat till the required length is achieved.
4. Bump and feed the line before it becomes too short and fall back into the bump head. If this happens refer to the section of "Trimmer Line Assembly – bump head" on page 9.

Note: refer to "Troubleshooting - Bump head" if the line is not coming out when bumping.

**Warning : DO NOT touch the bump head while the engine is running.
DO NOT Bump feed excessive lengths on line longer than the limits of the guards.**



Trimming Procedures

Practical tips

- Practice all operating techniques with the engine switched off before you start to use the machine.
- Remove Weed/Grass wrapped around Head/Shaft.



DO NOT use steel wire or plastic-coated steel wire of any kind with your string head. Serious operator injury can result.



Periodically remove weed wrap to prevent overheating the drive shaft. Weed wrap occurs when strands of weed become entangled around the shaft beneath the debris shield. This condition prevents the shaft from being properly cooled.

- When properly equipped with a guard and cutting head, your unit will trim unsightly weeds and tall grass in those hard-to-reach areas – along fences, walls, foundations and around trees. It can also be used for scalping to remove vegetation down to the ground for easier preparation of a garden or to clean out a particular area.



Trimming around foundations, brick or stone walls, curves, etc. will result in above normal string wear.

Trimming / Mowing

- Swing trimmer with a sickle-like motion from side to side. Do not tilt the cutting head during the procedure. Test area to be trimmed for proper cutting height. Keep string head at same level for even depth of cut.

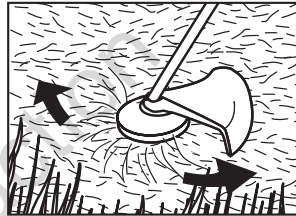

Fence / Foundation Trimming

- Approach trimming around chain link fences, picket fences, rock walls and foundations slowly to cut close without whipping string against the barrier. If the string comes in contact with rock, brick walls, or foundations, it will break or fray. If string snags fencing, it will snap off.

Trimming Around Trees

- Trim around tree trunks with a slow approach so string does not contact bark. Walk around the tree trimming from left to right. Approach grass or weeds with the tip of the string and tilt cutting head slightly forward.

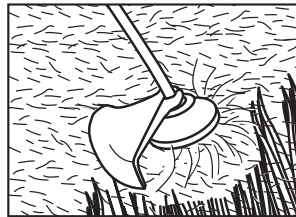

Scalping

- Scalping refers to removal of all vegetation down to the ground. To do this, tilt the cutting head to about 30 degree angle to the left. By adjusting the handle you will have better control during this operation. Do not attempt this procedure if there is any chance flying debris could injure operator, other people or cause damage to property.



Use extreme caution when SCALPING. Keep a distance of 100 feet (30 metres) between operator, other people and animals during these operations.



MAINTENANCE & CARE

Maintenance - Air Filter

Maintenance of the air filter

Always switch off the machine and pull out of spark plug H.T. lead before carrying out any maintenance work.

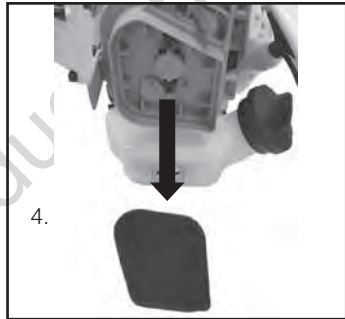

NOTE: Dirty air filters reduce the engine output by supply too little air to the carburettor.

Regular checks of the air filter is essential. The air filter should be checked monthly and cleaned if necessary. The air filter should be checked more frequently when used in dry and dusty environments.

1. Remove the air filter cover
2. Remove the filter element
3. Clean the filter element by washing in soapy water and allowing it to dry completely.
4. Soak in 2 stroke oil and squeeze off excess.
5. Assemble in reverse order.



Never clean the air filter with petrol or inflammable solvents.



Make sure Air Filter is fitted correctly, (warranty will be void if engine is damaged due to incorrect fitment)



Maintenance - Spark Plug

VICTA # HA25735A
BOSCH # WSR6F
NGK # BPMR7A
CHAMPION # RC J6Y

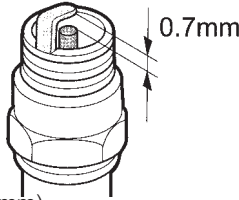

Your trimmer may be fitted with a NGK or CHAMPION spark plug.

Spark plug gap = 0.025 inch (0.7 mm).

Tighten the spark plug with a torque of 12-15 Nm.

Check the spark plug for dirt and grime after 10 hours of operation and if necessary clean.

Thereafter service the spark plug after every 50 hours of operation.

1. Pull off the spark plug boot by twisting side to side gently. (Fig 1)
2. Remove the spark plug with a spark plug tube spanner. (Fig 2)
3. Assemble in reverse order.



Storage



If you fail to follow these instructions correctly before storing the machine, deposits may form on the interior of the carburettor & may result in the engine being more difficult to start or the machine suffering permanent damage.

Storage Preparation

1. Carry out all the maintenance work require prior to storing.
2. Drain the fuel out of the tank.
3. When the fuel has been drained, start the engine.
4. Allow the engine to run at idling speed until it stops. This will clean the remainder of the fuel out of the carburettor.
5. Leave the machine to cool (approx. 5 minutes).
6. Remove the spark plug.
7. Place a teaspoon full of 2-stroke engine oil into the combustion chamber. Pull the starter cable several times carefully to wet the internal components with the oil. Refit the spark plug.
8. Clean the exterior housing of the machine.
9. Store the machine in a cold, dry place where it is out of the reach of ignition sources & inflammable substances.

Fertilizers and other chemical garden products often contain substances that accelerate the rate of corrosion of metals. Do not store the machine on or near fertilizers or other chemicals.

Before restarting

Remove the spark plug & pull the starter cord several times to clean & pour the oil out of the combustion chamber. Clean the spark plug contacts or fit a new spark plug.

Transport

To transport the machine, first empty the petrol tank. Pump the primer to completely remove fuel from the carburettor & empty excess from the tank.

Clean coarse dirt off the machine with a brush.

Dismantle the split shaft as described (pg.8) if preferred.



MAINTENANCE & CARE

Maintenance Chart

Refer to the following table for routine maintenance.

Features	Requirements	Before	After finish	Refuelling	Monthly	Yearly	If d'amaged	As required
Trimmer	Visual inspection (leaks)	●		●				
Throttle lever	Check operation	●						
Throttle trigger interlock	Check	●						
Stop switch	Check	●						
Fuel tank	Clean		●					
Cutting Head Assy	Check & clean		●					●
Gearbox	Grease (straight shaft)					●		●
Air filter	Check				●			
	Clean				●			●
	Replace (Depending on conditions)						●	●
Cowling	Clean		●					
Cylinder fins	Clean							●
Spark plug	Clean & readjust gap					●		●
Nylon Line	Stock replacement					●		●
Bump Head	Inspect	●	●					●
Cast Trimmer Head	Clean	●						
	Replacement						●	●
All accessible fasteners	Retighten	●						●
Muffler	Inspect	●			●			
	Inspect spark arresting screen					●		●
	Clean or replace						●	●



Always stop the engine before any maintenance is done on the unit. When all parts have stopped rotating, remove the spark plug lead to begin maintenance work.



Never repair cutting attachments by welding, straightening or custom reworking of parts. This may result in product failure or serious injury.



Never attempt maintenance that is not outlined in this manual. All repair work must be carried out by a VICTA Authorised Service Centre.



Troubleshooting

Problem	Possible cause	Remedy	
Engine will not start	Electrode is wet or fouled	Dry spark plug or replace	
Spark plug (no spark)	Carbon deposit on electrode	Clean spark plug	
	Cracked insulator	Replace spark plug	
Ignition system (no spark)	STOP SWITCH in OFF position	Switch to ON	
	Too small or large electrode gap	Adjust gap to 0.7mm (0.025")	
	Burned electrode	Replace spark plug	
Engine won't start - Good compression, sufficient fuel (with spark)	Coil burned out, coil insulation failure	Contact Service Centre	
	Break in coil wire, transistor burned out	Contact Service Centre	
Poor compression, sufficient fuel (with spark)	Engine flooded	Crank engine choke off to discharge fuel Wide throttle position	
	Excessively thick fuel	Contact Service Centre	
	Use of incorrect fuel	Drain and replace with correct fuel	
No fuel in carburettor (with spark)	Excessive wear on cylinder, piston, rings	Contact Service Centre	
	Loose spark plug	Tighten spark plug	
Insufficient power	No fuel in tank	Refuel	
	Loose fuel line fitting	Contact Service Centre	
	Clogged fuel line		Contact Service Centre
			Contact Service Centre
	Plugged air vent in fuel tank	Clean vent/Contact Service Centre	
Blockages	Clogged air filter	Clean	
	Carbon build up in muffler	Contact Service Centre	
Overheating	Fuel line/passage clogged	Contact Service Centre	
	Piston seizure, diaphragm inoperative	Contact Service Centre	
	Water in fuel	Contact Service Centre	
	Excessively lean fuel mixture	Contact Service Centre	
	Carbon deposits on piston	Contact Service Centre	
Engine makes knocking noise	Improper fuel mixing ratio	Replace with correct 25:1 fuel mix	
	Machine is overworked	Operate properly – do not overload	
	Fan cover, cylinder fins, etc. dirty	Clean and remove dirt and debris	
	Cylinder overheating	Clean fins	
	Use of incorrect fuel	Replace with correct fuel	



TROUBLESHOOTING

Troubleshooting

Problem	Possible cause	Remedy
Poor acceleration Fuel system clogged	Fuel filter clogged	Contact Service Centre
	Excessively low idle	Speed up idle/Contact Service Centre
	Excessively lean carburettor setting	Contact Service Centre
	Clogged air filter	Clean filter
Air leakage	Loose carburettor	Contact Service Centre
	Loose fuel pick up tube	Insert firmly/Contact Service Centre
Engine stops during operation Engine stops abruptly	Switch is bumped	Keep hands clear of switch
	Shorting of spark plug	Clean spark plug
	Piston scored, ignition failure	Contact Service Centre
Miscellaneous	Fuel tank empty	Refuel
	Carburettor or fuel tank clogged	Contact Service Centre
Engine is difficult to shut off Overheating or electrical fault	Overheated engine	Run at idle
	Overheated spark plug	Clean and adjust gap to 0.7mm (0.25")
	Defective kill switch	Contact Service Centre
	Poor contact of ground wire	Contact Service Centre
Unit main body Irregular vibration or trimmer head spins with engine idling	Loose trimmer head	Tighten firmly
	Broken clutch spring, bent main shaft	Contact Service Centre
	Worn shaft bearings	Contact Service Centre
	Loose gear head	Tighten bolt securely/Contact Service Centre
Bump head: Line doesn't come out when head is bumped	Inappropriate winding of line.	Open bump head and rewind the line ("Fitting trimmer line - bump head" on page 9)
	Line inside bump head is nearly finished.	Replace the residual line with the new line ("Fitting trimmer line - bump head" on page 9)

If running difficulties continue, contact your closest VICTA Authorised Service Centre in Australia and New Zealand. Please look up and locate your local Authorised Service Centre on www.victa.com.au or contact Victa Lawncare Customer Service. Refer to the warranty card for the contact details.



Not for
Reproduction



Not for
Reproduction

Not for
Reproduction

©2017 Briggs & Stratton Australia Pty Ltd

Victa is a trademark of Briggs & Stratton Australia Pty Ltd

All rights reserved. No part of this booklet may be reproduced by any means without prior written permission. All information herein is subject to change without notice.

LR02593A-C

2100	C	JRM	PB	Revised	04/07/2017
2100	B	JRM	PB	Production	03/07/2017
2100	A	JRM	PB	Production	20/06/2017
ECR	Rev	Own	Chk	Release	Date