



# **FULL BOAR**

## **MULTI PURPOSE MIXER**

- **1600W**
- **VARIABLE SPEED**
- **2 GEAR SETTINGS**
- **160MM MIXING  
PADDLE**



## **INSTRUCTION MANUAL**



**WARNING:** Read all safety warnings and all instructions. Failure to follow the warnings and instructions may result in electric shock, fire and/or serious injury. Save all warnings and instructions for future reference.

## SPECIFICATIONS - MODEL NO. FBT-1600

<b>Voltage:</b>	230-240V ~50Hz
<b>Power:</b>	1600W
<b>No Load Speed:</b>	180-460min <sup>-1</sup> / 300-700min <sup>-1</sup>
<b>Speed Settings:</b>	2
<b>Mixing Paddle Size:</b>	Ø160mm x 570mm
<b>Mixing Paddle Thread:</b>	M14 x 2.0mm
<b>Weight:</b>	4.6kg

## KNOW YOUR PRODUCT

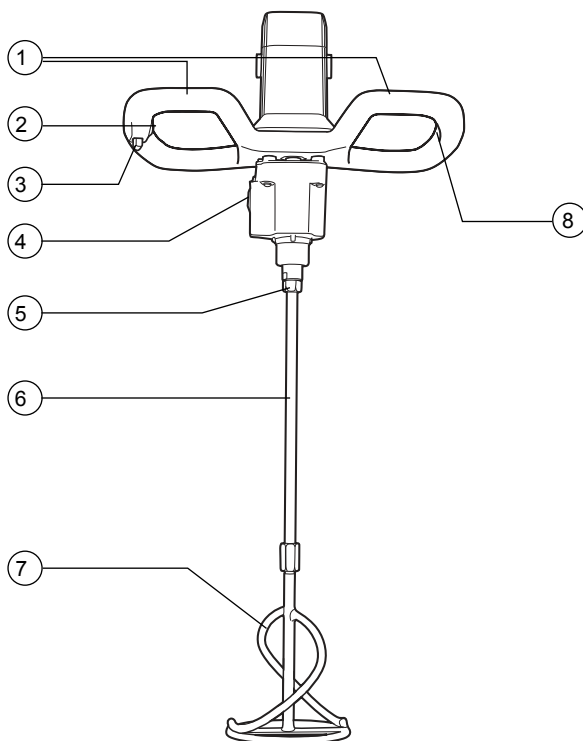

1. Side Handles
2. Lock-on Button
3. On/Off Trigger
4. Gear Selecting Switch

5. Collet
6. Mixing Shaft
7. Mixing Paddle
8. Variable Speed Dial

## TABLE OF CONTENTS

SPECIFICATIONS.....	Page 02
KNOW YOUR PRODUCT.....	Page 02
INTRODUCTION.....	Page 04
SAFETY INSTRUCTIONS.....	Page 04
ASSEMBLY.....	Page 08
OPERATION.....	Page 09
MAINTENANCE.....	Page 11
TROUBLE SHOOTING .....	Page 12
DESCRIPTION OF SYMBOLS.....	Page 12
CONTENTS.....	Page 13
WARRANTY.....	Page 14

## INTRODUCTION

Congratulations on purchasing a Full Boar Multi Purpose Mixer.

Your Full Boar Multi Purpose Mixer FBT-1600 has been designed to mix various materials such as paint, mortar, adhesives and plaster into consistent batches as required for the end user.

## ELECTRICAL SAFETY



**WARNING! When using mains-powered tools, basic safety precautions, including the following, should always be followed to reduce risk of fire, electric shock, personal injury and material damage.**

Read the whole manual carefully and make sure you know how to switch the tool off in an emergency, before operating the tool. Save these instructions and other documents supplied with this tool for future reference. The manufacturer cannot accept any liability for damage or accidents which arise due to a failure to follow these instructions and the safety information.

This product has been designed for 230V and 240V only. Always check that the power supply corresponds to the voltage on the rating plate. **Note:** The supply of 230V and 240V is interchangeable for Australia and New Zealand.



This tool is double insulated therefore no earth wire is required.

The power supply for this product should be protected by a residual current device (rated at 30mA or less). A residual current device reduces the risk of electric shock.

If the supply cord is damaged, it must be replaced by the manufacturer, its service agent or similarly qualified persons in order to avoid a hazard.

**Note:** Double insulation does not take the place of normal safety precautions when operating this tool. The insulation system is for added protection against injury resulting from a possible electrical insulation failure within the tool.

### Using an Extension Lead

Always use an approved extension lead suitable for the power input of this tool. Before use, inspect the extension lead for signs of damage, wear and ageing. Replace the extension lead if damaged or defective.

When using an extension lead on a reel, always unwind the lead completely. Use of an extension lead not suitable for the power input of the tool or which is damaged or defective may result in a risk of fire and electric shock.

# GENERAL SAFETY INSTRUCTIONS



**WARNING!** Read all safety warnings and all instructions. Failure to follow the warnings and instructions may result in electric shock, fire and/or serious injury.

Save all warnings and instructions for future reference. The term “power tool” in the warnings refers to your mains-operated (corded) power tool or battery-operated (cordless) power tool.

## 1. Work area safety

- a. **Keep work area clean and well lit.** Cluttered or dark areas invite accidents.
- b. **Do not operate power tools in explosive atmospheres, such as in the presence of flammable liquids, gases or dust.** Power tools create sparks which may ignite the dust or fumes.
- c. **Keep children and bystanders away while operating a power tool.** Distractions can cause you to lose control.

## 2. Electrical safety

- a. **Power tool plugs must match the outlet. Never modify the plug in any way. Do not use any adapter plugs with earthed (grounded) power tools.** Unmodified plugs and matching outlets will reduce risk of electric shock.
- b. **Avoid body contact with earthed or grounded surfaces, such as pipes, radiators, ranges and refrigerators.** There is an increased risk of electric shock if your body is earthed or grounded.
- c. **Do not expose power tools to rain or wet conditions.** Water entering a power tool will increase the risk of electric shock.
- d. **Do not abuse the cord. Never use the cord for carrying, pulling or unplugging the power tool. Keep cord away from heat, oil, sharp edges or moving parts.** Damaged or entangled cords increase the risk of electric shock.
- e. **When operating a power tool outdoors, use an extension cord suitable for outdoor use.** Use of a cord suitable for outdoor use reduces the risk of electric shock.
- f. **If operating a power tool in a damp location is unavoidable, use a residual current device (RCD) protected supply.** Use of an RCD reduces the risk of electric shock.

## 3. Personal safety

- a. **Stay alert, watch what you are doing and use common sense when operating a power tool. Do not use a power tool while you are tired or under the influence of drugs, alcohol or medication.** A moment of inattention while operating power tools may result in serious personal injury.
- b. **Use personal protective equipment. Always wear eye protection.** Protective equipment such as dust mask, non-skid safety shoes, hard hat, or hearing protection used for appropriate conditions will reduce personal injuries.
- c. **Prevent unintentional starting. Ensure the switch is in the off-position before connecting to power source and/or battery pack, picking up or carrying the tool.** Carrying power tools with your finger on the switch or energising power tools that have the switch on invites accidents.
- d. **Remove any adjusting key or wrench before turning the power tool on.** A wrench or a key left attached to a rotating part of the power tool may result in personal injury.
- e. **Do not overreach. Keep proper footing and balance at all times.** This enables better control of the power tool in unexpected situations.
- f. **Dress properly. Do not wear loose clothing or jewellery. Keep your hair, clothing and gloves away from moving parts.** Loose clothes, jewellery or long hair can be caught in moving parts.
- g. **If devices are provided for the connection of dust extraction and collection facilities, ensure these are connected and properly used.** Use of dust collection can reduce dust-related hazards.

## 4. Power tool use and care

- a. **Do not force the power tool. Use the correct power tool for your application.** The correct power tool will do the job better and safer at the rate for which it was designed.
- b. **Do not use the power tool if the switch does not turn it on and off.** Any power tool that cannot be controlled with the switch is dangerous and must be repaired.
- c. **Disconnect the plug from the power source and/or the battery pack from the power tool**

## GENERAL POWER TOOL SAFETY WARNINGS

**before making any adjustments, changing accessories, or storing power tools.** Such preventive safety measures reduce the risk of starting the power tool accidentally.

- d. **Store idle power tools out of the reach of children and do not allow persons unfamiliar with the power tool or these instructions to operate the power tool.** Power tools are dangerous in the hands of untrained users.
  - e. **Maintain power tools. Check for misalignment or binding of moving parts, breakage of parts and any other condition that may affect the power tool's operation. If damaged, have the power tool repaired before use.** Many accidents are caused by poorly maintained power tools.
  - f. **Keep cutting tools sharp and clean.** Properly maintained cutting tools with sharp cutting edges are less likely to bind and are easier to control.
  - g. **Use the power tool, accessories and tool bits etc. in accordance with these instructions, taking into account the working conditions and the work to be performed.** Use of the power tool for operations different from those intended could result in a hazardous situation.
- 5. Service**
- a. **Have your power tool serviced by a qualified repair person using only identical replacement parts.** This will ensure that the safety of the power tool is maintained.

## MULTI PURPOSE MIXER SAFETY WARNINGS

**Use auxiliary handle(s), if supplied with the tool.** Loss of control can cause personal injury.

**Hold power tool by insulated gripping surfaces, when performing an operation where the cutting accessory may contact hidden wiring or its own cord.** Cutting accessory contacting a "live" wire may make exposed metal parts of the power tool "live" and could give the operator an electric shock.



**WARNING! This appliance is not intended for use by persons** (including children) with reduced physical, sensory or mental capabilities, or lack of experience and knowledge, unless they have been given supervision or instruction concerning use of the appliance by a person responsible for their safety.

**Recommendations for the use of a residual current device** with a rated residual current of 30mA or less.

- Always use the side handle, this gives you greater control of the accessory should become jammed.
- Keep the cord clear of the accessory being used, do not wrap the cord around your arm or wrist.
- Hold the tool by the insulated gripping surfaces when performing an operation where the accessory may contact hidden wiring or its own cord.
- Use thick cushioned gloves and limit the exposure time by taking frequent breaks.
- Vibration caused by the hammer action may be harmful to your hands and arms.
- When removing an accessory from the tool avoid contact with skin and use proper protective gloves when grasping the bit or accessory. Accessories may be hot after prolonged use.
- Young children should be supervised to ensure that they do not play with the appliance.

## MULTI PURPOSE MIXER SAFETY WARNINGS



**WARNING!** Some dust created by power sanding, sawing, grinding, drilling and other construction activities contain chemicals known to cause cancer, birth defects or other reproductive harm.

Some examples of these chemicals are:

- Lead from lead-based paints;
- Crystalline silica from bricks, cement and other masonry products, and;
- Arsenic and chromium from chemically-treated timber.

The risk from such exposures vary depending on how often you do this type of work. To reduce your exposure to these chemicals; work in a well ventilated area, and work with approved safety equipment, such as those dust masks that are specifically designed to filter out microscopic particles. Always wear eye protection and a dust mask for dusty applications and when drilling/chiselling overhead. Sanding particles can be absorbed by your eyes and inhaled easily and may cause health complications.

### **Special requirements:**

- Wear ear protectors. Exposure to noise can cause hearing loss.
- Use auxiliary handles supplied with the tool. Loss of control can cause personal injury.

## ASSEMBLY

 **WARNING!** Ensure the tool is turned off and disconnected from the power supply before performing any of the following operations.

### Assembling and Fitting the Mixing Paddle

The Full Boar FBT-1600 comes with a mixing paddle that needs assembly before fitting to the multi purpose mixer.

1. Screw the mixing paddle into the end of the mixing shaft by rotating in a clockwise direction by hand (Fig. 1).

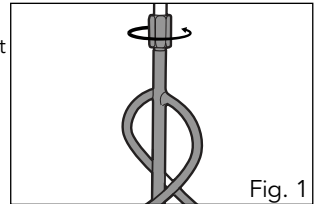

2. Screw the mixing shaft into the collet at the base of the mixer housing (Fig. 2).

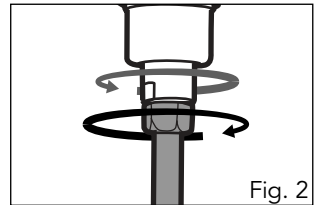

3. Tighten the collet using the provided 22mm spanners in opposite direction (Fig. 2).

4. Tighten the mixing paddle nut using a 22mm spanner (Fig. 1).



# OPERATION

## On/Off Trigger

1. To start the mixer, depress the on/off trigger (Fig. 3).

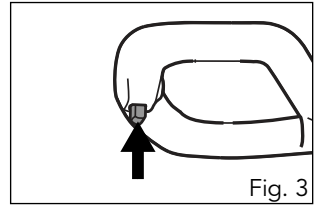

2. To stop the mixer, release the on/off trigger (Fig. 4).



**CAUTION:** The mixing may take a few seconds to come to a complete stop once the on/off trigger is released. Ensure the motor has come to a standstill before sitting the mixer down.

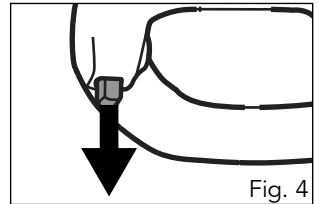

## Lock-on Button

The lock-on button allows the mixer to continue to operate without having to hold the on/off trigger down.

1. Start the mixer by depressing and holding the on/off trigger (Fig. 3).
2. Depress the lock-on button. Once it has been pressed, the on/off switch can be released while the mixer remains on.
3. To stop the mixer, depress the on/off trigger down and then release (Fig. 5).

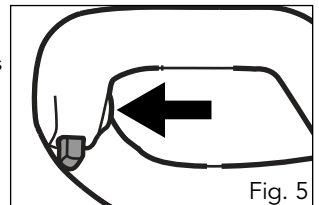

# OPERATION

## Varying the Speed

The multi purpose mixer has a variable speed dial and a gear selecting switch, which allows the mixer to obtain speeds from 180-700/min (1st gear: 180-460/min, 2nd gear: 300-700/min).

### Adjusting the Variable Speed Lever

1. To reduce the speed rotate the variable speed dial by turning it to the left (Fig. 6).
2. To increase the speed rotate the variable speed dial by turning it to the right (Fig. 6).

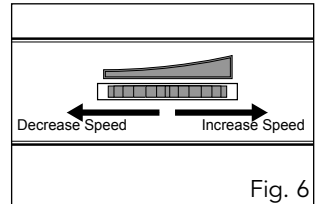

## Changing Gears



**CAUTION:** To avoid damaging any gears, ensure the mixer has completely stopped before changing gears.

1. To change to 2nd gear for faster speeds, push the gear selecting switch down (Fig. 7).
2. To change to 1st gear for slower speeds, push the gear selecting switch up (Fig. 7).

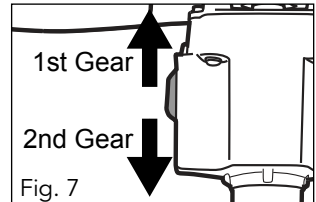

**Note:** The gears may require the mixing shaft to be slightly rotated to allow the gears to change.

## MAINTENANCE

- Keep the ventilation vents of the mixer clean at all times.
- To clean the mixing shaft and paddle first remove from the housing by unscrewing the collet. Then use water to wash off any unwanted material.
- After each use, blow air through the mixer housing to ensure it is free from all dust particles which may build up. Build up of dust particles may cause the mixer to overheat and fail.
- If the enclosure of the mixer requires cleaning, do not use solvents but a moist soft cloth only. Never let any liquid get inside the mixer; never immerse any part of the mixer into a liquid.

### Carbon Brushes

When the carbon brushes wear out, the Multi Purpose Mixer will stop. Discontinue use as soon as this happens. They should be replaced prior to recommencing use of the Multipurpose Mixer. Carbon brushes are a wearing component of the Multi-purpose Mixer and therefore not covered under warranty. Continuing to use the Multi-purpose Mixer when carbon brushes need to be replaced may cause permanent damage to the tool. Carbon brushes will wear out after many uses but when the carbon brushes need to be replaced take the Multi-purpose Mixer to an electrician or a power tool repairer for a quick and low cost replacement. Always replace both carbon brushes at the same time.

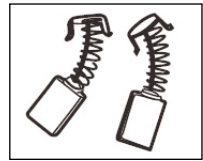





*Note: Ozito Industries will not be responsible for any damage or injuries caused by the repair of the mixer by an unauthorised person or by mishandling of the mixer.*

## TROUBLESHOOTING

Problem	Cause	Remedy
<b>Mixer is not working</b>	No power supplied	Make sure all plugs are connected and power outlet is in working order
<b>Mixer not reaching required speed</b>	Incorrect variable speed dial setting	Rotate the variable speed dial to increase the max speed
	Incorrect gear selection	Change into 2nd gear using the gear selection switch
<b>Excessive sparking visible through air vents</b>	Carbon brushes have worn out	Replace carbon brushes or contact customer service.

## DESCRIPTION OF SYMBOLS

V	Volts	Hz	Hertz
~	Alternating current	W	Watts
min <sup>-1</sup>	Revolutions or reciprocation per minute	n <sub>0</sub>	No load speed
∅	Diameter		Regulator compliance mark
	Double insulated		Warning
	Read operation instruction		Wear ear, eye and breathing protection

## CARING FOR THE ENVIRONMENT



Power tools that are no longer usable should not be disposed of with household waste but in an environmentally friendly way. Please recycle where facilities exist. Check with your local council authority for recycling advice.



Recycling packaging reduces the need for landfill and raw materials. Reuse of recycled material decreases pollution in the environment. Please recycle packaging where facilities exist. Check with your local council authority for recycling advice.

## CONTENTS

1 x Multi Purpose Mixer

1 x Mixing Paddle

1 x Mixing Shaft

Distributed by:  
Ozito Industries Pty Ltd

**AUSTRALIA (Head Office)**

1-23 Letcon Drive, Bangholme Victoria, Australia, 3175

Telephone: 1800 069 486

# WARRANTY

**YOUR WARRANTY FORM SHOULD BE RETAINED BY YOU AT ALL TIMES. IN ORDER TO MAKE A CLAIM UNDER THIS WARRANTY YOU MUST RETURN THE PRODUCT TO YOUR NEAREST BUNNINGS WAREHOUSE (see [www.bunnings.com.au](http://www.bunnings.com.au) or [www.bunnings.co.nz](http://www.bunnings.co.nz) for store locations) WITH YOUR BUNNINGS REGISTER RECEIPT. PRIOR TO RETURNING YOUR PRODUCT FOR WARRANTY PLEASE TELEPHONE OUR CUSTOMER SERVICE HELPLINE:**

**Australia 1800 069 486  
New Zealand 0508 069 486**

TO ENSURE A SPEEDY RESPONSE PLEASE HAVE THE MODEL NUMBER AND DATE OF PURCHASE AVAILABLE. A CUSTOMER SERVICE REPRESENTATIVE WILL TAKE YOUR CALL AND ANSWER ANY QUESTIONS YOU MAY HAVE RELATING TO THE WARRANTY POLICY OR PROCEDURE.

## **1 YEAR WARRANTY**

Your product is guaranteed for a period of **12 months from the original date of purchase**. If a product is defective it will be repaired in accordance with the terms of this warranty. Warranty excludes consumable parts, for example: wheels, bearings.

The benefits provided under this warranty are in addition to other rights and remedies which are available to you under law. The warranty covers manufacturer defects in materials, workmanship and finish under normal use.

Our goods come with guarantees that cannot be excluded under Australian Consumer law & Consumer Guarantees Act 1993 (NZ). You are entitled to a replacement or refund for a major failure and to compensation for other reasonably foreseeable loss or damage. You are also entitled to have the goods repaired and replaced if the goods fail to be of acceptable quality and the failure does not amount to a major failure.

## **WARRANTY EXCLUSIONS**

**The following actions will result in the warranty being void.**

- If the tool has been operated on a supply voltage other than that specified on the tool.
- If the tool shows signs of damage or defects caused by or resulting from abuse, accidents or alterations.
- Failure to perform maintenance as set out within the instruction manual.
- If the tool is disassembled or tampered with in any way.
- The warranty excludes damage resulting from product misuse or product neglect.

**This warranty is given by Ozito Industries Pty Ltd.**

**ABN: 17 050 731 756**

**Ph.1800 069 486**

Australia/New Zealand (Head Office)  
1-23 Letcon Drive, Bangholme, Victoria, Australia 3175