

**IMPORTANT NOTES**

1. This product is two sided with a dual function. For internal tiled applications, install sheet with label 'This side DOWN for TILES' facing down. For internal vinyl/carpet applications, install sheet with label 'This side UP for VINYL' facing up.
2. Scyon™ Secura™ Interior flooring is not suitable for external use.
3. Failure to install, finish or maintain this product in accordance with applicable building codes, regulations, standards and this guide may lead to personal injury, affect system performance, violate local building codes, and void James Hardie's product warranty.
4. Make sure your information is up to date. When specifying or installing James Hardie® products, ensure that you have the current technical information and guides. If in doubt, or you need more information, visit [www.jameshardie.com.au](http://www.jameshardie.com.au) or Ask James Hardie™ on 13 11 03.

**SCYON™ SECURA™ INTERIOR FLOORING**

PRODUCT	DESCRIPTION					
<p>19mm or 22mm</p> <p>Tiled Application Vinyl Application</p> <p>Long Edge Sheet Join Options</p>	<p>A sealed multi purpose structural flooring product for both tiled or vinyl/ carpet covered internal flooring applications.</p> <ul style="list-style-type: none"> <li>• 19mm thick Scyon™ Secura™ Interior flooring board has white edges.</li> <li>• 22mm thick Scyon™ Secura™ Interior flooring board has dark grey edges.</li> </ul> <p>Long edges have a tongue and groove feature for easy jointing.</p>					
<b>SIZE MM (NOMINAL)</b>						
WIDTH	LENGTH	THICKNESS	JOIST CENTRES (mm)	MASS (kg)	PART NO.	UNITS /PACK
600	2700	19	450	40	404173	20
900	1800	19	450	40	403550	20
600	2400	22	600	41	404691	20

**NOTES**

1. All dimensions and masses provided are approximate only and subject to manufacturing tolerances. Masses are based on approximate moisture content of product leaving manufacturing plant.

**PRODUCT / ACCESSORIES / TOOLS**
**SUPPLIED BY JAMES HARDIE**

ACCESSORIES	DESCRIPTION	ACCESSORIES	DESCRIPTION
	<b>HardieBlade™ Saw Blade. 185mm diameter</b> A 185mm diameter poly-diamond blade for fast and clean cutting of James Hardie fibre cement. 1 each. Part No. 300660		<b>James Hardie™ Joint Sealant. 300ml cartridge and 600ml Sausage</b> A general purpose, paintable, exterior grade polyurethane joint sealant. Used for sealing of all sheet joints and can be used to adhere sheets to framing. 300ml tube 20 per box. 1 each. Part No. 305534 600ml sausage 20 per box . 1 each. Part No. 305672
	<b>HardieDrive™ Screw 40mm long.</b> A class 3 finish self-tapping wing-tipped screw for fastening to 0.8mm to 1.6mm BMT steel frames. 500 per box. Part No. 305533		

**NOT SUPPLIED BY JAMES HARDIE**

James Hardie recommends the following products for use in conjunction with its Scyon™ Secura™ Interior flooring. James Hardie does not supply these products and does not provide a warranty for their use. Please contact the product manufacturer for information on their warranties and further information on their products.

ACCESSORIES	DESCRIPTION	ACCESSORIES	DESCRIPTION
	<b>Nails</b> • 2.8 x 50mm corrosion resistant fibre cement nails. • 50mm corrosion resistant D Head gun nails.		<b>Gun Nailer</b> Suitable pneumatic or coil gun nailer.
	<b>Ring Shank Nail</b> Paslode Impulse IM90i50 50x2.87mm DekFast Armor Galvanised Ring D Head B33050T for fixing Scyon Secura Flooring to narrow I-joists		<b>Cordless Drill</b> Recommended tool for screw fixing the sheets to steel and timber framing.
	<b>Screws</b> № 8 x 40mm Corrosion resistant self embedding head for screwing to timber framing.		<b>Spatula</b> For spreading James Hardie joint sealant over all sheet joints and fasteners in wet areas.
	<b>QuikDrive Collated Screw</b> 42mm long Class 3 screw for fixing to 0.8 - 1.6mm BMT steel framing. Part No. CBSDG158SA		<b>Vacuum Extraction with HEPA filter</b> Used with HEPA filter and paper bag for reduced dust exposure.
	<b>Dust-reducing Saw</b> Dust reducing saw with a HardieBlade™ saw blade.		<b>Backing Rod</b> Used to create control joints. 10mm diameter
	<b>Construction Adhesive</b> Suitable construction adhesive for gluing sheets to floor frame. James Hardie joint sealant may be used.		

**WARNING**
**DO NOT BREATHE DUST AND CUT ONLY IN WELL VENTILATED AREA**

James Hardie products contain sand, a source of respirable crystalline silica which is considered by some international authorities to be a cause of cancer from some occupational sources. Breathing excessive amounts of respirable silica dust can also cause a disabling and potentially fatal lung disease called silicosis, and has been linked with other diseases. Some studies suggest smoking may increase these risks. During installation or handling:

- (1) work in outdoor areas with ample ventilation;
- (2) minimise dust when cutting by using either 'score and snap' knife, fibre cement shears or, where not feasible, use a HardieBlade™ saw blade and dust-reducing circular saw attached to a HEPA vacuum;
- (3) warn others in the immediate area to avoid breathing dust;
- (4) wear a properly-fitted, approved dust mask or respirator (e.g. P1 or P2) in accordance with applicable government regulations and manufacturer instructions to further limit respirable silica exposures. During clean-up, use HEPA vacuums or wet cleanup methods - never dry sweep.

For further information, refer to our installation instructions and Material Safety Data Sheets available at [www.scyon.com.au](http://www.scyon.com.au). FAILURE TO ADHERE TO OUR WARNINGS, MATERIAL SAFETY DATA SHEETS, AND INSTALLATION INSTRUCTIONS MAY LEAD TO SERIOUS PERSONAL INJURY OR DEATH.

**JAMES HARDIE RECOMMENDED SAFE WORKING PRACTICES**
**CUTTING OUTDOORS**

1. Position cutting station so wind will blow dust away from the user or others in working area.
2. Use a dust reducing circular saw equipped with HardieBlade™ saw blade and HEPA vacuum extraction.

**SANDING/DRILLING/OTHER MACHINING**

When sanding, drilling or machining you should always wear a P1 or P2 dust mask and warn others in the immediate area.

**IMPORTANT NOTES**

1. NEVER use a power saw indoors.
2. NEVER use a circular saw blade that does not carry the HardieBlade™ logo.
3. NEVER dry sweep - Use wet suppression or HEPA vacuum.
4. NEVER use grinders.
5. ALWAYS follow tool manufacturers' safety recommendations.

P1 or P2 respirators should be used in conjunction with above cutting practices to further reduce dust exposures. Additional exposure information is available at [www.jameshardie.com.au](http://www.jameshardie.com.au) to help you determine the most appropriate cutting method for your job requirements. If concern still exists about exposure levels or you do not comply with the above practices, you should always consult a qualified industrial hygienist or contact James Hardie for further information.

**STORAGE AND HANDLING**

To avoid damage, all James Hardie building products should be stored with edges and corners of the sheets protected from damage.

James Hardie building products must be installed in a dry state and protected from weather during transport and storage. The stored product must be laid flat under cover on a smooth level surface clear of the ground to avoid exposure to water, moisture, etc.

Protective gloves must be worn while handling sheets.

## SCOPE AND OVERVIEW

This installation guide covers the use of Scyon™ Secura™ Interior flooring sheets in a vinyl/carpet and tiled application in an internal application over timber or light gauge steel frames.

## DESIGN General

All design and construction must comply with the appropriate requirements of the current Building Code of Australia (BCA) and other applicable regulations and standards.

## Responsibility

The specifier or other party responsible for the project must ensure that the details in this guide are appropriate for the intended application and that additional detailing is performed for specific design or any areas that fall outside the scope of this guide.

## Loading

For residential indoor applications, both 19mm and 22mm Scyon™ Secura™ Interior flooring sheets satisfy the concentrated load and Uniformly Distributed Load (UDL) of 1.8kN and 2kPa respectively with floor joist centres indicated in table 1.

**Table 1**  
**MAXIMUM FLOOR JOIST CENTRES**

SHEET THICKNESS	JOIST CENTRES (MM)
19	450
22	600

For commercial applications, 22mm Scyon™ Secura™ Interior flooring sheets are structurally designed to withstand various loads categories in Table 3.1 of AS/NZS 1170.1 – Structural design actions – Permanent, imposed and other actions' for unfactored working stress loads stated in Table 2.

**Table 2**  
**MAXIMUM ALLOWABLE LOADS**

THICKNESS (mm)	JOIST CENTRES (mm)	POINT LOAD (0.01M <sup>2</sup> SIZE)	UDL ALLOWABLE
22	450	3.6 kN	5 KPa
22	600	2.7 kN	5 KPa

## FRAMING General

Scyon™ Secura™ Interior flooring may be fixed to either durable timber or corrosion resistant light gauge steel frame joist centres. Floor joist must be a nominal of 45mm wide (except for Narrow Timber I Joists and LVL solid joist). Framing must have the appropriate level of durability required to prevent corrosion or deterioration.

## Timber Framing

Use of timber framing must be in accordance with AS1684 - 'Residential timber-framed construction', dry kiln, and in accordance with the framing manufacturer's specifications.

- Narrow Timber I Joists (min. 40mm wide): Refer to table 3 for specific fastener requirements. The flange of the joist profile must have an adequate depth to ensure full fastener embedment.
- LVL solid joist (min. 42mm wide): Refer to table 3 for specific fastener requirements.

## Steel Framing

Framing members must have a 0.75mm to 1.9mm BMT (base metal thickness) and be in accordance with NASH standard for Residential and Low Rise Steel Framing Part 1 and manufacturer's specifications.

## Tolerances

Framing is to be straight and true. Suggested frame tolerance in all directions is 3-4mm over 3m.

## FASTENERS

**Table 3**  
**FASTENER SELECTION**

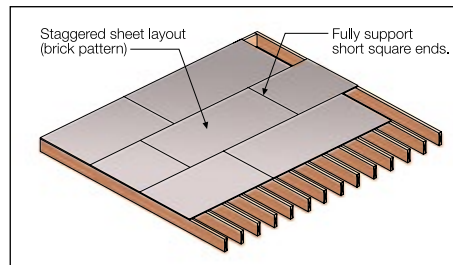
PRODUCT	TIMBER JOISTS (MIN. 45MM WIDE)	NARROW I-JOIST	LVL SOLID JOIST	STEEL JOISTS 0.75 - 1.6MM BMT	STEEL JOISTS BETWEEN 1.6 TO 1.9MM BMT
2.8 x 50mm FC nails	✓				
50mm D Head gun nails	✓				
No.8 x 40mm CSK self drilling screw	✓	✓	✓		
40mm HardieDrive screw				✓	
40mm CSK self drilling screws					✓*
50x2.87mm DekFast Ring D Head nail	✓	✓	✓		

NOTE: All fasteners must have a minimum Class 3 finish. \*Refer to manufacturer's specifications for suitability.

## SHEET LAYOUT AND SIDE UP

Install sheets across the floor joists with the short sheet edges fully supported on joists in a staggered pattern.

For internal tiled applications, install sheet with label 'This side DOWN for TILES' facing down. For internal vinyl/carpet applications, install sheet with label 'This side UP for VINYL' facing up.



**FIGURE 1 SHEET LAYOUT - TILING AND VINYL**

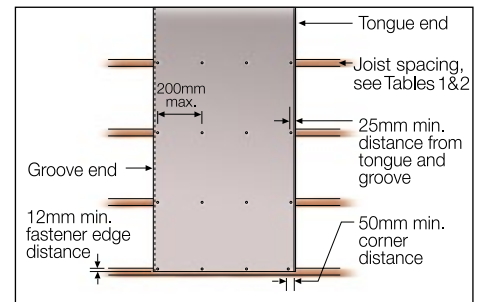
## INSTALLATION STEPS

### NOTES

1. Ensure the product meets aesthetic and product size specifications before installation. James Hardie will not be responsible for rectifying aesthetic surface variations following installation.
2. The sheet is multi purpose and depending on the finish, the short sheet ends may or may not need a gap. As a result, creep at the short sheet ends will occur and over many sheets additional floor joists may be required.



**FIGURE 2 CONSTRUCTION ADHESIVE**



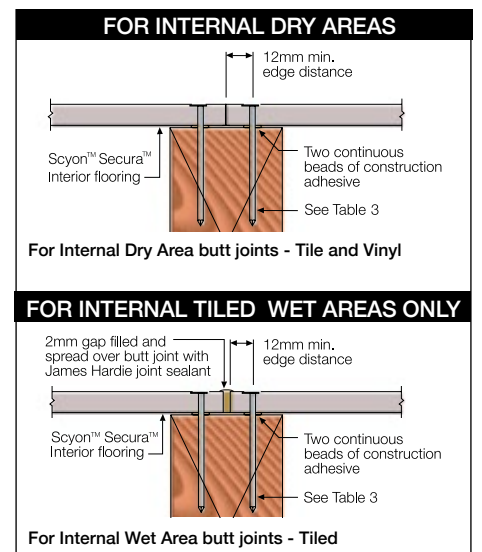
**FIGURE 3 FASTENER LAYOUT**



**FIGURE 4 FIXING 1ST PANEL**

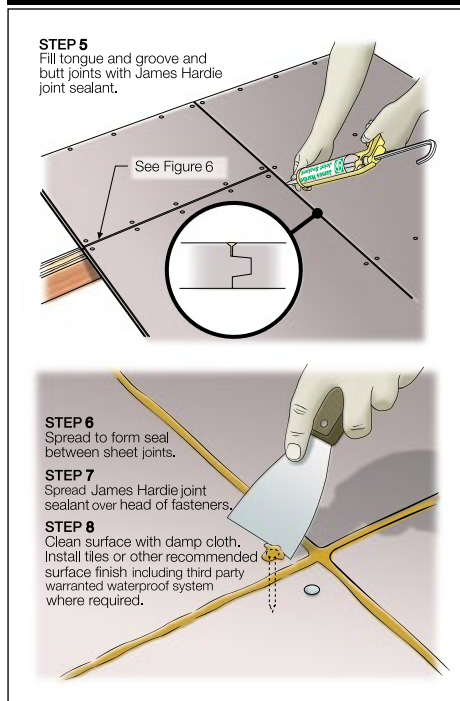


**FIGURE 5 FIXING 2ND PANEL**



**FIGURE 6 BUTT JOINING OPTIONS**

**FOR INTERNAL TILED WET AREAS ONLY**



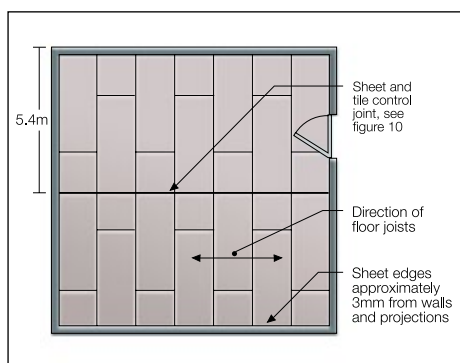
**FIGURE 7 SEALING FASTENERS AND JOINTS**

NOTE: Avoid excessive foot traffic on the floor for at least 24-48 hours to allow sealant to set and dry out. Protect the surface of the sheets from damage until final finish is applied.

**CONTROL JOINTS**

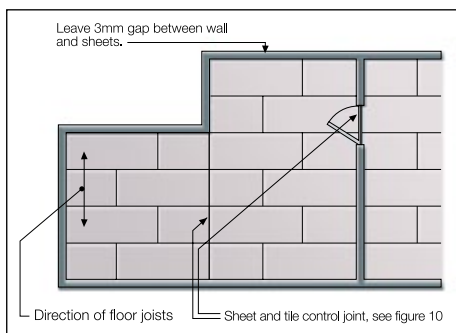
**Tiled dry and wet areas only**

Control joints in the floor sheets and thus through the tiles are required in dry and wet areas where floor dimensions exceed 5.4m in the long sheet direction and where existing structural joints are located, see below. For 22mm Scyon™ Secura™ Interior flooring, it may be more practical to have the control joints every 4.8 metres along the length of the sheets to coincide with sheet size.

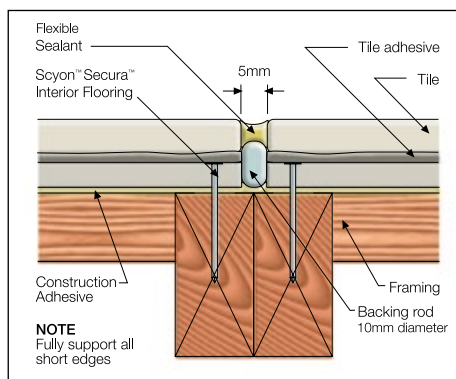


**FIGURE 8 SHEET CONTROL JOINT LAYOUT**

Also provide control joints where there are changes of direction, such as an L-shaped room, and at doorways where the tiled surface is carried through to the next room as shown.



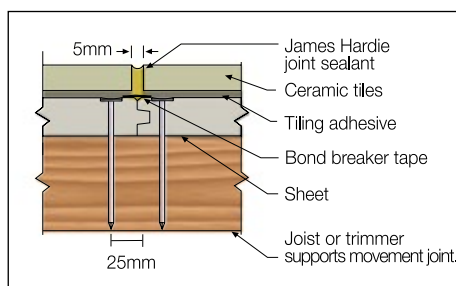
**FIGURE 9 L-SHAPED ROOM**



**FIGURE 10 CONTROL JOINTS - SHEET & TILE JOINT**

Additional control joints in the tiles are required in both directions, refer to AS3958.1 and Figure 11 for more information.

NOTE: No control joints are required in the flooring sheets when finishing with vinyl and carpet unless there is an existing structural joint or otherwise specified by relevant code and regulation.



**FIGURE 11 CONTROL JOINTS - TILE**

**FINISHES**

Ensure all components are fully compatible with one another and warranted for the intended application with Scyon™ Secura™ Interior flooring including tiles, vinyl, and waterproofing system and tile and vinyl adhesive.

**Preparation**

Where minor height variations (3mm or less) occur at sheet butt joints, these may be levelled out by filling with Ardex's Feather Finish. Sanding of the Scyon™ Secura™ Interior flooring is not recommended. Ensure sheets are fully dry and clean before applying finishes.

**Wet Areas**

This guide must be read in conjunction with James Hardie's Wet Area Construction application guide, AS 3740, AS 3958.1 and the BCA. Install floor tiles in

accordance with tile manufacturer's specifications within 3 months of installation.

At the time of writing the following third party companies for warranted waterproofing systems for use with Scyon™ Secura™ Interior flooring.

- Ardex Australia Pty Ltd
- Bostik Australia Pty Ltd
- Crommelin
- ParexDavco Australia.

**Vinyl**

In Internal wet and dry areas, vinyl can be directly fixed to the sheets. In high risk areas of a wet area eg. shower, a warranted and tested waterproofing system is required.

As the sheets are sealed, it recommended that the vinyl adhesive is allowed to air dry longer to become tacky before laying down the vinyl sheets. Dunlop® Vinyl Adhesive, Polymer Vinyl Adhesive 265 from Polymer Engineering and Fullers® Perfect Putdown floor adhesive are water based and may be used. Refer to the above vinyl manufacturers for suitable warranted tested products and installation instructions.

**Tiling**

In Internal wet and dry areas, tiles can either be directly fixed to the sheets or laid on a sand-cement mortar bed over the sheets. Brittle tile finishes such as slate and marble may need to be laid on a 30mm thick reinforced bed. Refer to tile supplier for warranted specifications and AS 3958.1.

Tiles must be applied with proprietary flexible adhesive applicable for tile thickness and size nominated in code and by tile adhesive company that conforms to ISO 13007.1 for Ceramic Tiles and Adhesives. Use a flexible tile adhesive that is warranted and is suitable for use with Scyon™ Secura™ Interior flooring and tiles used.

Tiles are laid from the control joint out and edges of tiles must overlap butt joints a minimum of 50mm.

Refer to the waterproofing and tile manufacture and relevant tiling codes for maximum tile control joint spacing, tile adhesive thickness and application, product suitability and compatibility including grout, tile adhesive, tile and waterproofing warranty and maintenance requirement.

**MAINTENANCE**

Cleaning and maintenance of the finished surface, joints, junctions, penetrations etc must be carried out at regular intervals. Maintain waterproofing to meet the objectives of AS 3740 and as per the requirements of the relevant component manufacturer.

**PRODUCT INFORMATION**

**General**

Scyon™ Secura™ Interior flooring is an advanced cement composite. The basic composition is Portland cement, ground sand, cellulose fibre, water and proprietary additives. Scyon™ Secura™ Interior flooring is manufactured to AS/NZS 2908.2 'Cellulose-Cement Products Part 2: Flat Sheets'. Scyon™ Secura™ Interior flooring is classified Type B, Category 3 in accordance with AS/NZS 2908.2.

For Material Safety Data sheets (MSDS) visit [www.scyon.com.au](http://www.scyon.com.au) or Ask James Hardie™ on 13 11 03.

## **Durability**

### **Resistance to fire**

James Hardie flooring products have been tested to AS/ISO 9239, and exceed the requirements stipulated in the Building Code of Australia - Specification C1.10a Fire Hazard Properties – Floors, Walls & Ceilings. All James Hardie flooring products have critical radiant flux values greater than the minimum requirement of 4.5 kW/m<sup>2</sup> (highest value in accordance with Table 1), and a smoke development rate well below the maximum allowable smoke development rate of 750 percentage-minutes.

### **Resistance to termite attack**

Based on testing completed by CSIRO Division of Forest Products and Ensis Australia James Hardie building products have demonstrated resistance to termite attack.

## **WET AREAS APPRAISAL**

Scyon™ Secura™ Interior flooring has been appraised by CSIRO (Technical Assessment 318, July 2005) as satisfying the relevant requirements for use in internal wet areas.

## **SCYON™ SECURA™ INTERIOR FLOORING PRODUCT WARRANTY**

Scyon™ Secura™ Interior flooring sheets have a 10 year product warranty. For terms and conditions of product warranty, refer to [www.scyon.com.au](http://www.scyon.com.au), [www.accel.com.au](http://www.accel.com.au) or Ask James Hardie on 13 11 03

© Copyright 2013 James Hardie Australia Pty Ltd. ABN 12 084 635 558. ™ and ® denotes a trademark or registered mark owned by James Hardie Technology Limited

**Ask James Hardie™**  
**Call 13 11 03**  
**[www.jameshardie.com.au](http://www.jameshardie.com.au)**

