



18V LITHIUM ION

# BRUSHLESS LAWN MOWER

ORIGINAL INSTRUCTIONS

## SPECIFICATIONS

Voltage:	18V
Cutting Diameter:	300mm
Cutting Heights:	30, 50 & 70mm
No Load Speed:	3,300/min
Grass Catcher:	25 litres
Weight (Tool Only):	8.57kg

ozito.com.au

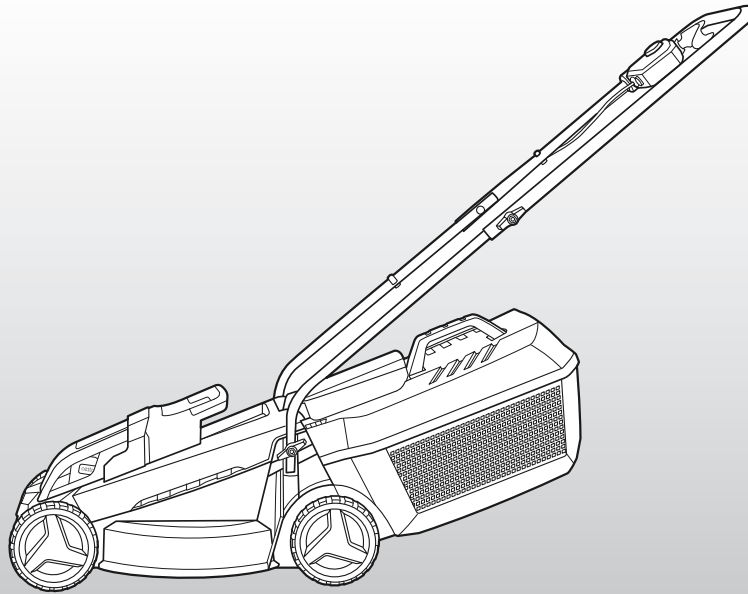

## STANDARD EQUIPMENT

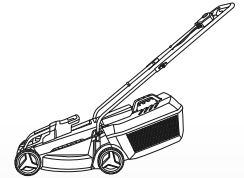

Brushless Lawn Mower



Safety Key

**5 YEAR**  
REPLACEMENT WARRANTY

PXCLMS-018

## WARRANTY

IN ORDER TO MAKE A CLAIM UNDER THIS WARRANTY YOU MUST RETURN THE PRODUCT TO YOUR NEAREST BUNNINGS WAREHOUSE WITH YOUR BUNNINGS REGISTER RECEIPT. PRIOR TO RETURNING YOUR PRODUCT FOR WARRANTY PLEASE TELEPHONE OUR CUSTOMER SERVICE HELPLINE:

**Australia 1800 069 486**

**New Zealand 0508 069 486**

TO ENSURE A SPEEDY RESPONSE PLEASE HAVE THE MODEL NUMBER AND DATE OF PURCHASE AVAILABLE. A CUSTOMER SERVICE REPRESENTATIVE WILL TAKE YOUR CALL AND ANSWER ANY QUESTIONS YOU MAY HAVE RELATING TO THE WARRANTY POLICY OR PROCEDURE.

### WARNING

The following actions will result in the warranty being void.

- If the tool has been operated on a supply voltage other than that specified on the tool.
- If the tool shows signs of damage or defects caused by or resulting from abuse, accidents or alterations.
- Failure to perform maintenance as set out within the instruction manual.
- If the tool is disassembled or tampered with in any way.

The benefits provided under this warranty are in addition to other rights and remedies which are available to you at law.

Our goods come with guarantees that cannot be excluded at law. You are entitled to a replacement or refund for a major failure and for compensation for any other reasonably foreseeable loss or damage. You are also entitled to have the goods repaired or replaced if the goods fail to be of acceptable quality and the failure does not amount to a major failure.

Generally you will be responsible for all costs associated with a claim under this warranty, however, where you have suffered any additional direct loss as a result of a defective product you may be able to claim such expenses by contacting our customer service helpline above.

### 5 YEAR REPLACEMENT WARRANTY

Your Product is guaranteed for a period of 60 months from the original date of purchase and is intended for DIY (Do It Yourself) use only. If a product is defective it will be replaced in accordance with the terms of this warranty. **Lithium Ion batteries and chargers are covered by a 36 month warranty.** Warranty excludes consumable parts, for example: grass catcher, wheels, blade, cord clips, bearings etc..

# KNOW YOUR PRODUCT

## BRUSHLESS LAWN MOWER

1. Wheels
2. Battery Cover
3. Lower Handle
4. Grass Catcher Flap
5. Handle Securing Set
6. Upper Handle
7. Start/Stop Lever
8. Lock-off Button
9. Grass Catcher
10. Handle Securing Knob
11. Lifting Handle

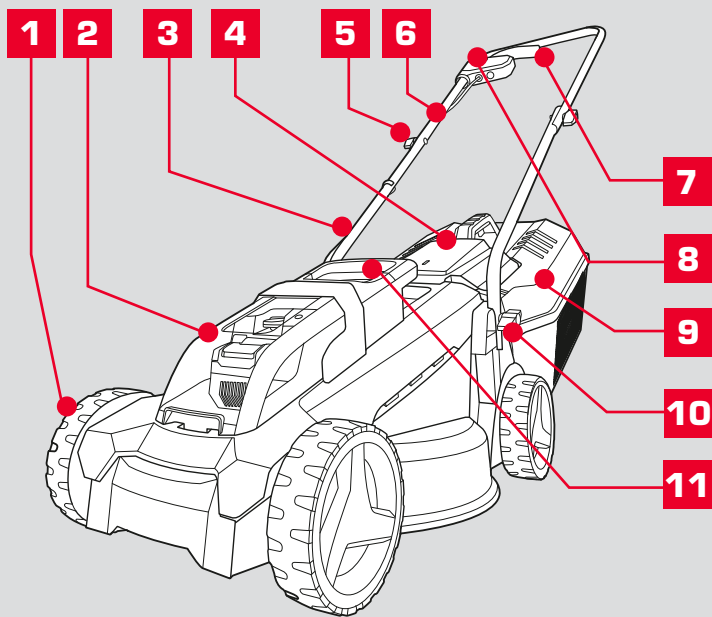

## ACCESSORIES

12. Safety Key

12



## BATTERY & CHARGER

This tool is compatible with all battery and chargers from the Ozito Power X Change Range.

## ONLINE MANUAL

Scan this QR Code with your mobile device to take you to the online manual.



# SETUP & PREPARATION

## 1. ASSEMBLY



**WARNING!** ENSURE THE TOOL IS SWITCHED OFF AND BATTERIES ARE DISCONNECTED BEFORE PERFORMING ANY OF THE FOLLOWING TASKS.

### Fitting the Lower Handles

1. Place the lower handle into the threaded ends.

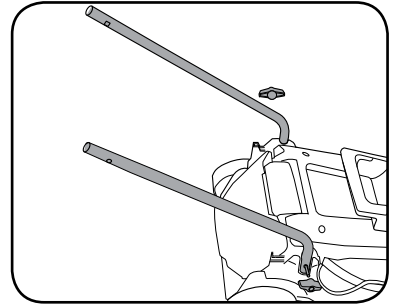

2. Secure with a handle securing knob.

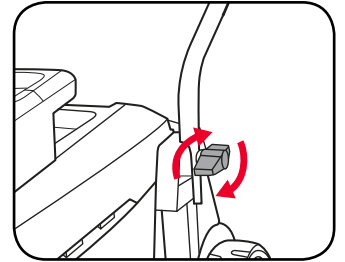

### Fitting the Upper Handle

1. Place the upper handle over the upper ends of the lower handle.
2. From the handle securing set, fit the bolts through the inner side of the lower handle and then through the holes in the upper handle.

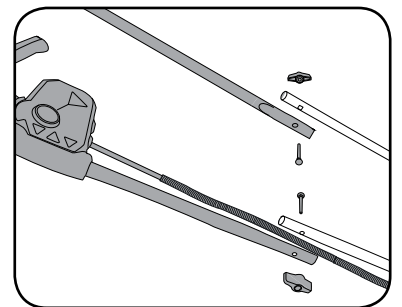

3. Secure in place by screwing the handle securing knobs over the protruding ends of the bolts.

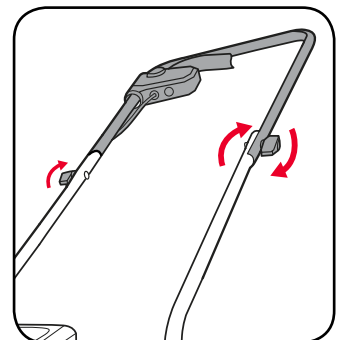

**5 YEAR**  
REPLACEMENT WARRANTY

## Securing the Cord

Ensure the cord follows the handle smoothly from the switch to the body of the mower.

1. Locate cord on outside of handle. Secure the power cord from the switch housing to the mower using 2 cable ties (supplied).

**Note:** Care should be taken not to impinge cord when folding down the handle.

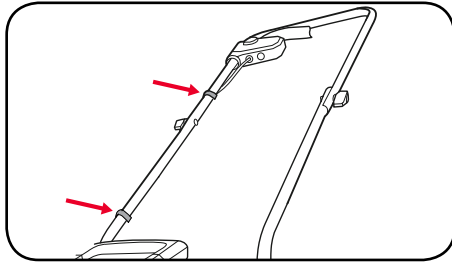

## Grass Catcher Assembly

1. To assemble the grass catcher align the two halves and push them together, one side at a time. Ensure the two halves click together around the entire middle section.
2. Assemble the grass catcher handle onto the opening on the top half of the grass catcher. The handle will click into position when aligned and fitted correctly.

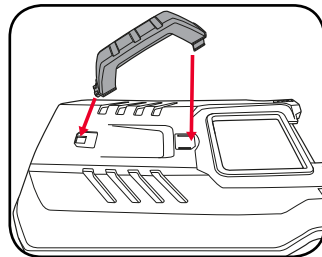
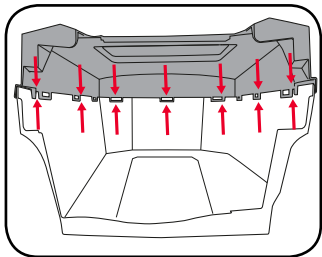

## Fitting and Removing the Grass Catcher



**IMPORTANT!** ONLY FIT AND REMOVE THE CATCHER WHEN THE MOWER IS SWITCHED OFF AND THE MOTOR HAS COME TO A STOP.

1. Lift up the catcher flap with one hand and guide the catcher with your other hand over the two hooks on the mower housing.
2. Lower the grass catcher and allow it to sit in place. Lower the catcher flap.

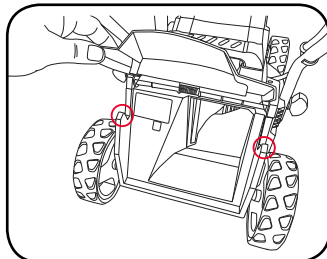

**Note:** The catcher flap is held against the grass catcher by a spring.

3. To remove, raise the flap and lift the catcher out.

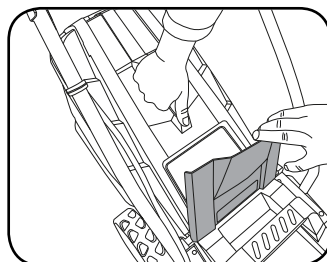

## 2. INSERTING AND REMOVING BATTERY

### Inserting the Battery into the Mower

Ensure only 3.0Ah and above batteries are used.

1. Open the battery cover.
2. Slide the battery into the mower aligning the ribs so that it clicks into place.

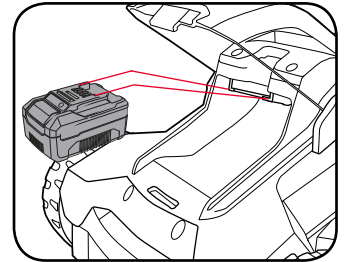
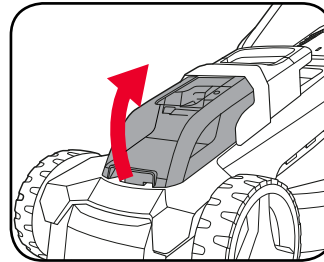

3. Insert the safety key. (If the mower is not going to be used immediately, do not insert the safety key.)
4. Close the battery cover.

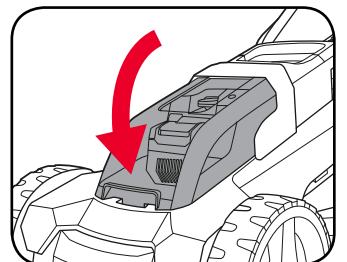
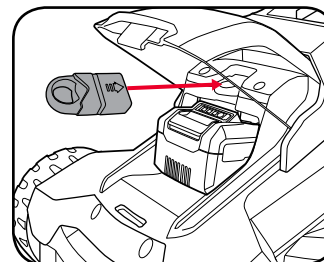

### Removing the Battery from the Mower

1. Open the battery cover.

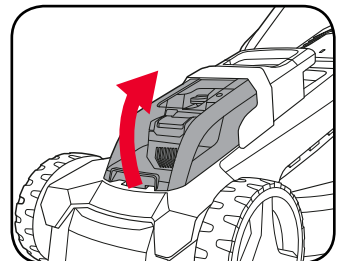

2. Press the battery release tab and remove the battery.

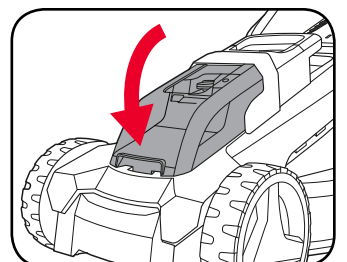
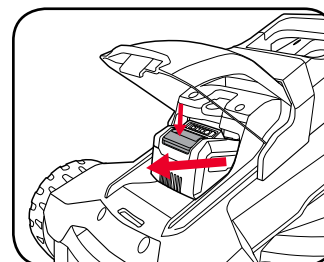

# OPERATION

## 3. CONTROLS

### Switching On and Off

To prevent accidental start up, the mower is fitted with a dual action switch.

1. Press and hold the lock-off button.

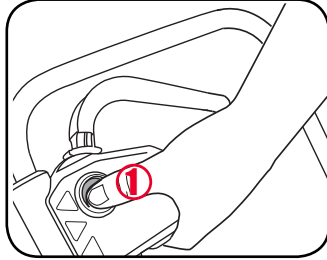

2. Pull the start/stop lever towards the handle to start the mower and then release the lock-off button.

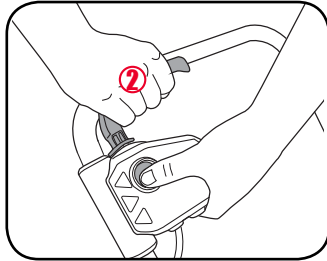

3. Release the start/stop lever to stop the mower.

### Adjusting the Cutting Height

To obtain the desired cutting height, the front and rear axles are repositioned on the underside of the mower housing.

1. Place the mower on its side.
2. Pull the wheel axle towards the front of the mower.
3. Locate the wheel axle into the desired cutting height adjustment position.

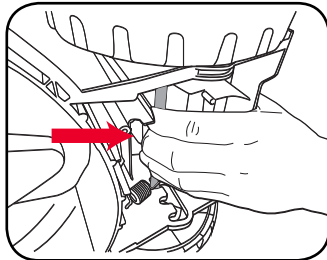

**Note:** Make sure that front, back, left & right wheels are located in the same cutting height adjustment position.

### Cutting Height Positions

- 1 - 30mm (lowest).
- 2 - 50mm.
- 3 - 70mm (highest).

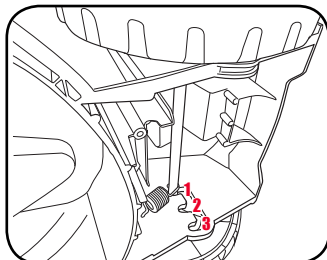

## 4. MOWING

- While using your lawn mower always wear substantial closed, heavy footwear and long trousers.
- Make sure the lawn is clear of sticks, stones, wire and debris; they could be thrown by the blade.
- Before using the lawn mower and after any impact, check for signs of wear or damage and repair as necessary.
- Replace a worn or damaged blade together with the blade bolt to preserve balance.

### Lawn Mowing Tips

Start mowing the edge of the lawn and work along making sure to overlap each pass by a few centimetres.

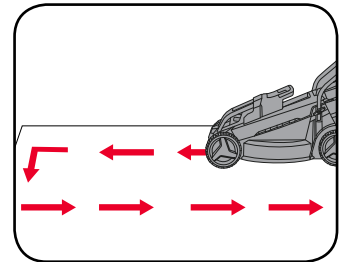

For optimum grass collection, always mow in a straight line; do not swing the lawn mower from side to side.

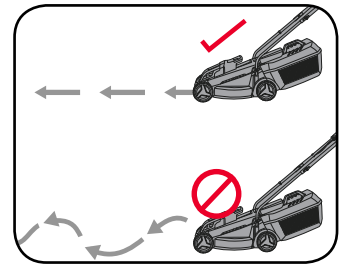

When mowing long grass be sure to not overload the motor. First cut with the highest cutting height and then to the desired height. This will help reduce the load.

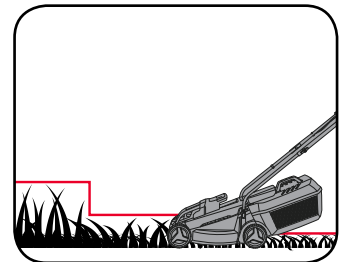

**IMPORTANT!** DO NOT MOW WITH POOR VISIBILITY CONDITIONS, IN THE RAIN OR WHEN GRASS IS WET.

# MAINTENANCE



**WARNING!** ALWAYS ENSURE THE LAWN MOWER BLADE HAS COMPLETELY STOPPED, REMOVE SAFETY KEY, BATTERY AND GRASS CATCHER PRIOR TO ANY MAINTENANCE.

## Removing and Fitting the Blade



**CAUTION!** ALWAYS USE GLOVES WHEN HANDLING THE BLADE. SHARP EDGES COULD CAUSE INJURY.

Only replace the blade with a genuine Ozito replacement blade, as this will ensure top performance and safety under all conditions.

- To remove the blade screw, hold the blade firmly and with a 13mm socket loosen the blade screw by turning it anti-clockwise.

**NOTE:** A piece of timber will assist in holding the blade while removing or tightening the blade bolt.

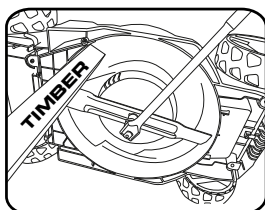

- Remove the blade screw, washer and blade.

**Replace the metal blade after 50 hours mowing or 2 years whichever is sooner. If the blade is cracked or damaged replace it with a new one.**

- To fit the blade, place the blade over the centre hole aligning the lugs.
- Then retighten the fastening screw with the universal wrench. The tightening torque should be approx. 25 Nm.

## Cleaning, Maintenance and Storage

- Keep all nuts, bolts and screws tight to be sure the lawn mower is in a safe working condition.
- Check the catcher frequently for wear or deterioration.
- Replace worn or damaged parts for safety.
- Only use the replacement blade and blade bolt specified for this product.
- Be careful during adjustments of the lawn mower to prevent entrapment of the fingers between moving blade and fixed parts of the machine.
- When not in use, the mower should be stored in a dry, frost-free location, out of reach of children. If the housing of the mower requires cleaning, do not use solvents but a moist soft cloth and brush only.
- Frequently check the wheel threads are firm and tight.

Note: Ozito Industries will not be responsible for any damage or injuries caused by the repair of the lawn mower by an unauthorised person or by mishandling of the lawn mower. This tool is designed for DIY use - use in commercial or industrial environments will void the warranty.

## Battery protection system

The tool is equipped with the battery protection system, which helps to ensure a long service life.

The output power automatically cuts off during operation when the tool and/or battery are placed under the following situations:

### • When the tool is overloaded:

If this occurs, release the start/stop lever safety key and batteries and remove causes of overload, then reinsert the safety key and batteries, then press and hold the lock-off button and pull the start stop lever again to restart.

### • When the remaining battery capacity becomes low:

Recharge the battery pack.

**Note:** The indicated capacity may be lower than the actual level during use or immediately after using the tool.

# CARING FOR THE ENVIRONMENT



Power tools that are no longer usable should not be disposed of with household waste but in an environmentally friendly way. Please recycle where facilities exist. Check with your local council authority for recycling advice.



Recycling packaging reduces the need for landfill and raw materials. Reuse of recycled material decreases pollution in the environment. Please recycle packaging where facilities exist. Check with your local council authority for recycling advice.

# TROUBLESHOOTING

Problem	Cause	Remedy
Mower is not starting	Possible clogging	Check underneath the mower and clear out as necessary
	Battery is low in charge	Charge battery
	Battery not inserted properly	Insert battery pack correctly
	Grass too long	Raise the cutting height to reduce starting load
	Safety key not inserted correctly	Fit correctly
Mower is hard to push	Height of cut too low	Raise cutting height
	Cutting blade blunt	Replace blade
	Possible clogging	Check underneath the mower and clear out as necessary
	Grass too long	Raise the cutting height and walk slower
	Grass too dense	Raise the cutting height and walk slower and cut more frequently
	Wet grass	Wait until the grass dries before mowing
Motor stops while cutting	Height of cut too low	Raise the cutting height
	Battery has no power	Charge battery
Mower is not catching grass properly	Height of cut too low	Raise the cutting height
	Wet grass	Wait until the grass dries before mowing
Mower vibrating	Bent or damaged blade	Replace blade

# DESCRIPTION OF SYMBOLS

<b>V</b>	Volts	<b>Hz</b>	Hertz
<b>~</b>	Alternating current	<b>W</b>	Watts
<b>dc/---</b>	Direct current	<b>∅</b>	Diameter
<b>mA</b>	Milliamperes	<b>No</b>	No load speed
<b>/min</b>	Revolutions or reciprocation per minute		Double insulated
	Regulator compliance mark		Transformer Energy Rating (MEPS)
<b>Nm</b>	Newton Meters		Read instruction manual
	Thermal cut-out protection		Pull out Safety Key before carry out any repair work
	Indoor use only		Warning
	Lithium Ion- battery		Do not use or store battery in temperatures exceeding 50°C
	Recycle battery		Do not put in the rubbish
	Do not incinerate		Do not get battery wet
	Always keep the lawnmower on the ground when mowing. Tilting or lifting the lawnmower may cause stones to be thrown out.		
	Keep bystanders away. Do not mow whilst people especially children or pets are in the mowing area.		
	Beware of severing toes or hands. Do not put hands or feet near a rotating blade.		
	Blade continues to rotate after the machine is switched off. Wait until all machine components have completely stopped before touching them.		
	Do not mow in the rain or leave the lawnmower outdoors while raining.		





# ELECTRICAL SAFETY



**WARNING!** When using mains-powered tools, basic safety precautions, including the following, should always be followed to reduce risk of fire, electric shock, personal injury and material damage.

Read the whole manual carefully and make sure you know how to switch the tool off in an emergency, before operating the tool.

Save these instructions and other documents supplied with this tool for future reference.

Before you connect the charger to the mains supply make sure that the data on the rating plate are identical to the mains data.



This tool's charger is double insulated, therefore no earth wire is required.

If the supply cord is damaged, it must be replaced by an electrician or a power tool repairer in order to avoid a hazard.

**Note:** Double insulation does not take the place of normal safety precautions when operating this tool. The insulation system is for added protection against injury resulting from a possible electrical insulation failure within the tool.

The power supply for this product's charger should be protected by a residual current device (rated at 30mA or less). A residual current device reduces the risk of electric shock.



# GENERAL POWER TOOL SAFETY WARNINGS



**WARNING!** Read all safety warnings and all instructions. Failure to follow the warnings and instructions may result in electric shock, fire and/or serious injury.

**Save all warnings and instructions for future reference. The term "power tool" in the warnings refers to your mains-operated (corded) power tool or battery-operated (cordless) power tool.**

## 1. Work area safety

- Keep work area clean and well lit.** Cluttered or dark areas invite accidents.
  - Do not operate power tools in explosive atmospheres, such as in the presence of flammable liquids, gases or dust.** Power tools create sparks which may ignite the dust or fumes.
  - Keep children and bystanders away while operating a power tool.** Distractions can cause you to lose control.
- ## 2. Electrical safety
- Power tool plugs must match the outlet. Never modify the plug in any way. Do not use any adapter plugs with earthed (grounded) power tools.** Unmodified plugs and matching outlets will reduce risk of electric shock.
  - Avoid body contact with earthed or grounded surfaces, such as pipes, radiators, ranges and refrigerators.** There is an increased risk of electric shock if your body is earthed or grounded.
  - Do not expose power tools to rain or wet conditions.** Water entering a power tool will increase the risk of electric shock.
  - Do not abuse the cord. Never use the cord for carrying, pulling or unplugging the power tool. Keep cord away from heat, oil, sharp edges or moving parts.** Damaged or entangled cords increase the risk of electric shock.
  - When operating a power tool outdoors, use an extension cord suitable for outdoor use.** Use of a cord suitable for outdoor use reduces the risk of electric shock.
  - If operating a power tool in a damp location is unavoidable, use a residual current device (RCD) protected supply.** Use of an RCD reduces the risk of electric shock.

## 3. Personal safety

- Stay alert, watch what you are doing and use common sense when operating a power tool. Do not use a power tool while you are tired or under the influence of drugs, alcohol or medication.** A moment of inattention while operating power tools may result in serious personal injury.
- Use personal protective equipment. Always wear eye protection.** Protective equipment such as dust mask, non-skid safety shoes, hard hat, or hearing protection used for appropriate conditions will reduce personal injuries.
- Prevent unintentional starting. Ensure the switch is in the off-position before connecting to power source and/or battery pack, picking up or carrying the tool.** Carrying power tools with your finger on the switch or energising power tools that have the switch on invites accidents.
- Remove any adjusting key or wrench before turning the power tool on.** A wrench or a key left attached to a rotating part of the power tool may result in personal injury.
- Do not overreach. Keep proper footing and balance at all times.** This enables better control of the power tool in unexpected situations.

- Dress properly. Do not wear loose clothing or jewellery. Keep your hair, clothing and gloves away from moving parts.** Loose clothes, jewellery or long hair can be caught in moving parts.
  - If devices are provided for the connection of dust extraction and collection facilities, ensure these are connected and properly used.** Use of dust collection can reduce dust-related hazards.
- ## 4. Power tool use and care
- Do not force the power tool. Use the correct power tool for your application.** The correct power tool will do the job better and safer at the rate for which it was designed.
  - Do not use the power tool if the switch does not turn it on and off.** Any power tool that cannot be controlled with the switch is dangerous and must be repaired.
  - Disconnect the plug from the power source and/or the battery pack from the power tool before making any adjustments, changing accessories, or storing power tools.** Such preventive safety measures reduce the risk of starting the power tool accidentally.
  - Store idle power tools out of the reach of children and do not allow persons unfamiliar with the power tool or these instructions to operate the power tool.** Power tools are dangerous in the hands of untrained users.
  - Maintain power tools. Check for misalignment or binding of moving parts, breakage of parts and any other condition that may affect the power tool's operation. If damaged, have the power tool repaired before use.** Many accidents are caused by poorly maintained power tools.
  - Keep cutting tools sharp and clean.** Properly maintained cutting tools with sharp cutting edges are less likely to bind and are easier to control.
  - Use the power tool, accessories and tool bits etc. in accordance with these instructions, taking into account the working conditions and the work to be performed.** Use of the power tool for operations different from those intended could result in a hazardous situation.
- ## 5. Battery tool use and care
- Recharge only with the charger specified by the manufacturer.** A charger that is suitable for one type of battery pack may create a risk of fire when used with another battery pack.
  - Use power tools only with specifically designated battery packs.** Use of any other battery packs may create a risk of injury and fire.
  - When battery pack is not in use, keep it away from other metal objects, like paper clips, coins, keys, nails, screws or other small metal objects, that can make a connection from one terminal to another.** Shorting the battery terminals together may cause burns or a fire.
  - Under abusive conditions, liquid may be ejected from the battery; avoid contact. If contact accidentally occurs, flush with water. If liquid contacts eyes, additionally seek medical help.** Liquid ejected from the battery may cause irritation or burns.
- ## 6. Service
- Have your power tool serviced by a qualified repair person using only identical replacement parts.** This will ensure that the safety of the power tool is maintained.



# LAWN MOWER SAFETY WARNINGS



**WARNING!** If not used properly this lawn mower can be dangerous!

This lawn mower can cause serious injury to the operator and others, the warnings and safety instructions must be followed to ensure reasonable safety and efficiency in using this lawn mower. The operator is responsible for following the warning and safety instructions in this manual and on the lawn mower. Never use the mower unless the catcher or guards provided by the manufacturer are in the correct position.

## 1) Training

- Read the instructions carefully. Be familiar with the controls and the proper use of the appliance.
- Never allow children or people unfamiliar with these instructions to use the appliance. Local regulations may restrict the age of the operator.
- Never mow while people, especially children, or pets are nearby.
- The operator or user is responsible for accidents or hazards occurring to other people or their property
- Know your controls. Read the manual carefully. Learn how to stop the engine quickly in an emergency.

## 2) Preparation

- While mowing, always wear substantial footwear and long trousers.
- Do not operate the appliance when barefoot or wearing open sandals.
- Thoroughly inspect the area where the appliance is to be used and remove all stones, sticks, wires, bones, and other foreign objects. They could be thrown by the blade.
- Before using, always visually inspect to see that the blades, blade bolts and cutter assembly are not worn or damaged. Replace worn or damaged blades and bolts in sets to preserve balance.

### DAMAGED BLADES AND WORN BOLTS ARE MAJOR HAZARDS.

- On multi-bladed appliances, take care as rotating one blade can cause other blades to rotate.

## 3) Operation

- Mow only in daylight or in good artificial light.
- Avoid operating the appliance in wet grass, where feasible.
- Always be sure of your footing on slopes.
- Walk, never run.
- For wheeled rotary mowers, mow across the face of slopes, never up and down.
- Exercise extreme caution when changing direction on slopes.
- Do not mow excessively steep slopes.
- Use extreme caution when reversing or pulling the appliance towards you.
- Never cut grass while walking backwards.
- Stop the blade(s) if the appliance has to be tilted for transportation when crossing surfaces other than grass, and when transporting the appliance to and from the area to be mowed such as gravel drives, walks or roads.
- Never operate the appliance with defective guards or shields, or without safety devices, for example deflectors and/or grass catchers, in place.
- Start the motor according to instructions and with feet well away from the blade(s).
- Do not tilt the appliance when starting the motor, except if the appliance has to be tilted for starting. In this case, do not tilt it more than absolutely necessary and lift only the part which is away from the operator. Always ensure that both hands are in the operating position before returning the appliance to the ground.
- Do not put hands or feet near or under rotating parts. For rotary mowers, keep clear of the discharge opening at all times.
- Never pick up or carry an appliance while the motor is running.

- Stop the motor:
  - whenever you leave the machine;
  - before clearing a blockage;
  - before checking, cleaning or working on the appliance;
  - after striking a foreign object. Inspect the appliance for damage and make repairs as necessary;
  - if the appliance starts to vibrate abnormally (check immediately).
- Do not over-speed the mower or alter governor settings. Excessive speed is dangerous and shortens mower life.

## 4) Maintenance and storage

- Keep all nuts, bolts, and screws tight to be sure the appliance is in safe working condition.
- Check the grass catcher frequently for wear or deterioration.
- Replace worn or damaged parts for safety.
- For cylinder mowers, be careful during adjustment of the appliance to prevent entrapment of the fingers between moving blades and fixed parts of the appliance.
- Store the mower in a well-ventilated room away from naked flames such that may be found in hot water heaters.

# SPARE PARTS

Spare parts can be ordered from the Special Orders Desk at your local Bunnings Warehouse.

For further information, or any parts not listed here, visit

[www.ozito.com.au](http://www.ozito.com.au) or contact Ozito Customer Service:

**Australia 1800 069 486**

**New Zealand 0508 069 486**

**E-mail: [enquiries@ozito.com.au](mailto:enquiries@ozito.com.au)**



18V LITHIUM ION

# CORDLESS GRASS TRIMMER

## INSTRUCTION MANUAL

### SPECIFICATIONS

Voltage:	18V
No Load Speed:	8,500/min
Cutting Diameter:	240mm
Weight:	1.3kg

[ozito.com.au](http://ozito.com.au)

**5 YEAR**  
REPLACEMENT WARRANTY

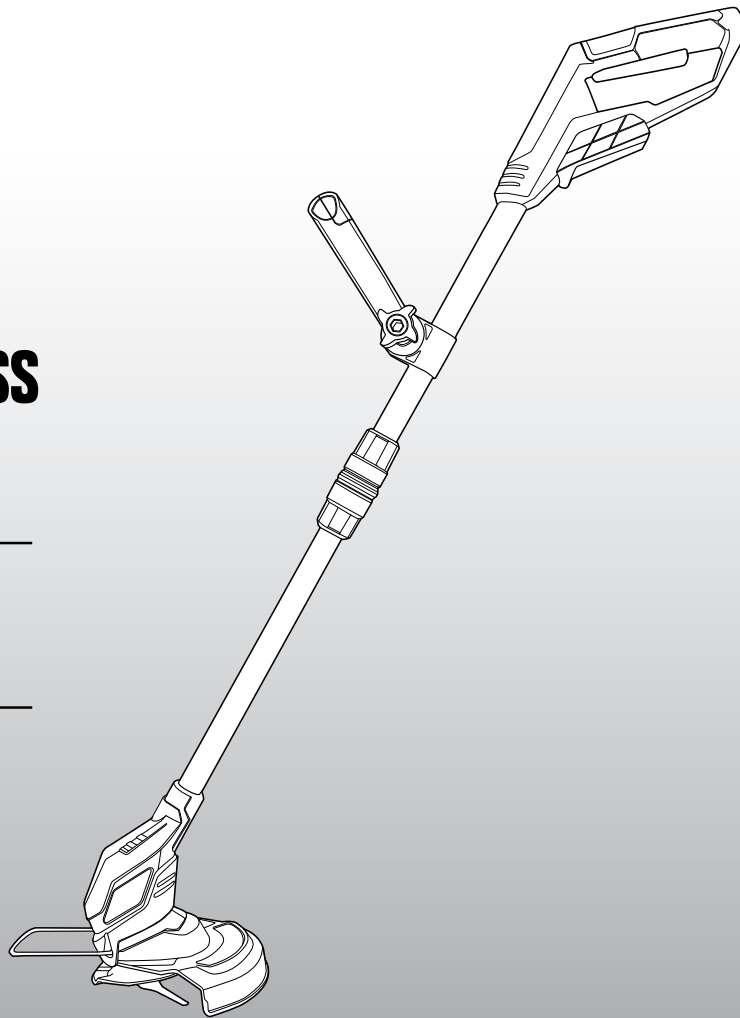

### STANDARD EQUIPMENT

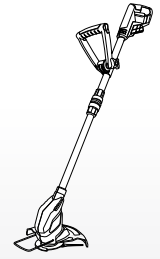

Grass Trimmer



Safety Guard

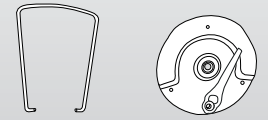

Flower Guard & Spindle Plate

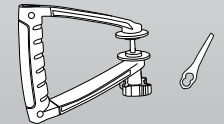

Adjustable Handle & Blades x 10

**PXCGTAS-018**

## WARRANTY

IN ORDER TO MAKE A CLAIM UNDER THIS WARRANTY YOU MUST RETURN THE PRODUCT TO YOUR NEAREST BUNNINGS WAREHOUSE WITH YOUR BUNNINGS REGISTER RECEIPT. PRIOR TO RETURNING YOUR PRODUCT FOR WARRANTY PLEASE TELEPHONE OUR CUSTOMER SERVICE HELPLINE:

**Australia 1800 069 486**

**New Zealand 0508 069 486**

TO ENSURE A SPEEDY RESPONSE PLEASE HAVE THE MODEL NUMBER AND DATE OF PURCHASE AVAILABLE. A CUSTOMER SERVICE REPRESENTATIVE WILL TAKE YOUR CALL AND ANSWER ANY QUESTIONS YOU MAY HAVE RELATING TO THE WARRANTY POLICY OR PROCEDURE.

### WARNING

The following actions will result in the warranty being void.

- If the tool has been operated on a supply voltage other than that specified on the tool.
- If the tool shows signs of damage or defects caused by or resulting from abuse, accidents or alterations.
- Failure to perform maintenance as set out within the instruction manual.
- If the tool is disassembled or tampered with in any way.

The benefits provided under this warranty are in addition to other rights and remedies which are available to you at law.

Our goods come with guarantees that cannot be excluded at law. You are entitled to a replacement or refund for a major failure and for compensation for any other reasonably foreseeable loss or damage. You are also entitled to have the goods repaired or replaced if the goods fail to be of acceptable quality and the failure does not amount to a major failure.

Generally you will be responsible for all costs associated with a claim under this warranty, however, where you have suffered any additional direct loss as a result of a defective product you may be able to claim such expenses by contacting our customer service helpline above.

### 5 YEAR REPLACEMENT WARRANTY

Your Product is guaranteed for a period of 60 months from the original date of purchase and is intended for DIY (Do It Yourself) use only. If a product is defective it will be replaced in accordance with the terms of this warranty. **Lithium Ion batteries and chargers are covered by a 36 month warranty.** Warranty excludes consumable parts, for example: Spindle plate, cutting blades.

# KNOW YOUR PRODUCT

## CORDLESS GRASS TRIMMER

- |                            |                    |
|----------------------------|--------------------|
| 1. Telescopic Shaft        | 6. On/Off Trigger  |
| 2. Shaft Adjustment Collar | 7. Battery Seating |
| 3. Adjustable Handle Knob  | 8. Flower Guard    |
| 4. Adjustable Handle       | 9. Cutter Head     |
| 5. Rear Handle             | 10. Safety Guard   |
|                            | 11. Blades x10     |

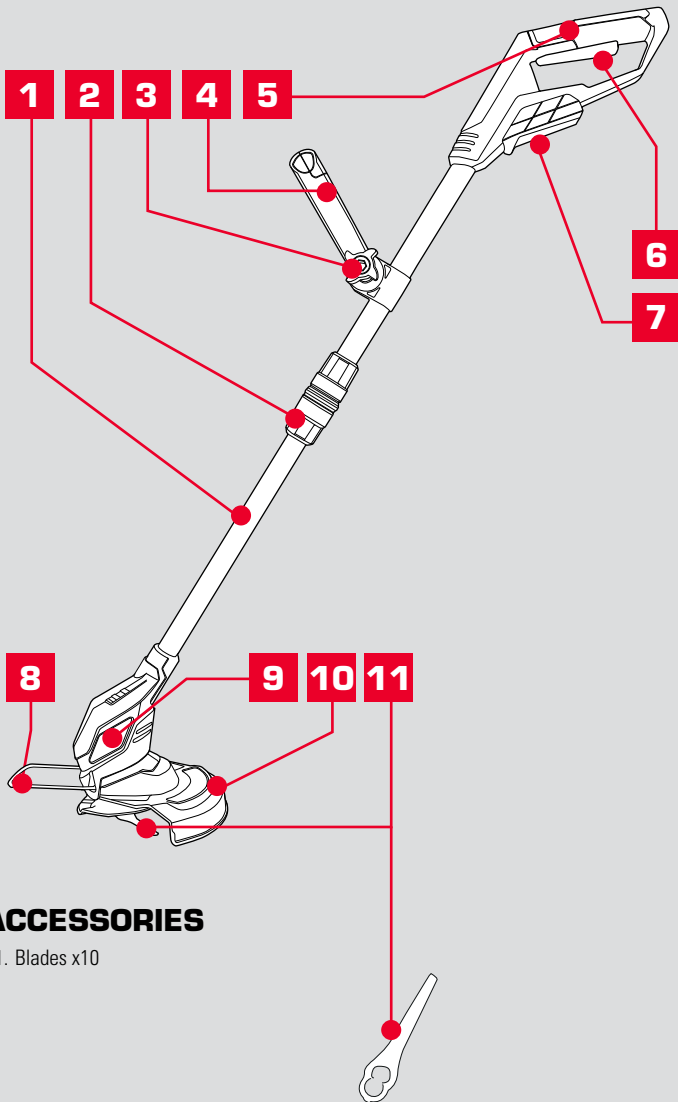

## ACCESSORIES

- 11. Blades x10

## BATTERY & CHARGER

This tool is compatible with all battery and chargers from the Ozito Power X Change Range.

## ONLINE MANUAL

Scan this QR Code with your mobile device to take you to the online manual.



**5 YEAR**  
REPLACEMENT WARRANTY

# SETUP & PREPARATION

## 1. ASSEMBLY

**WARNING!** ENSURE THE TOOL IS SWITCHED OFF AND BATTERY DISCONNECTED BEFORE PERFORMING ANY OF THE FOLLOWING TASKS.

### Fitting the Safety Guard

1. Turn the grass trimmer upside down. Align the tabs of the safety guard with the recess in the cutter head.
2. Slide in until it clicks into place.

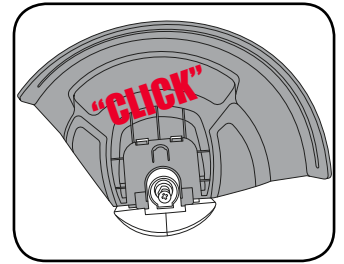
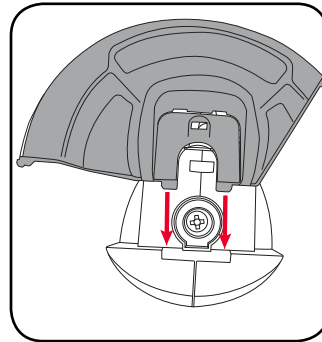

### Fitting the Spindle Plate

1. Place the spindle plate onto the spindle and secure in place with the screw provided.

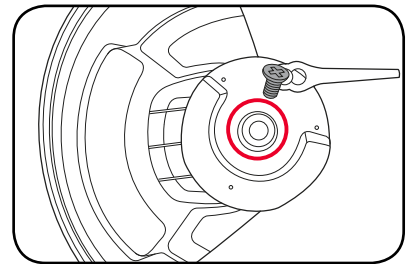

**WARNING!** NEVER USE THE GRASS TRIMMER UNLESS THE SAFETY GUARD IS PROPERLY FITTED.

### Fitting the Secondary Handle

1. Place the adjustable handle over the bracket so it is positioned correctly.
2. Secure with the supplied locking knob.

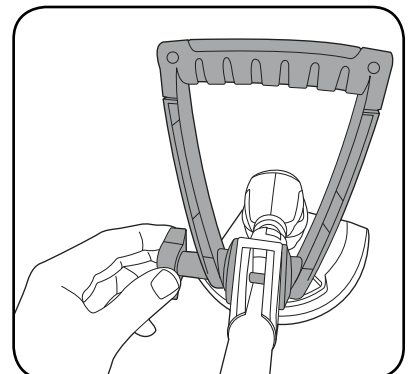



## Fitting the Flower Guard

1. Attach the flower guard to the motor housing.

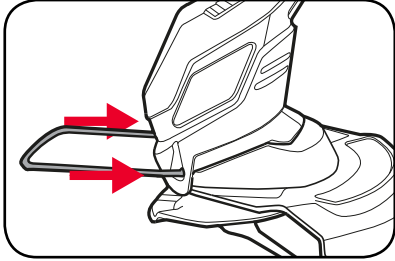

## Attaching a Blade

1. Place the big hole in the blade onto the blade mount on the bottom of the spindle plate.

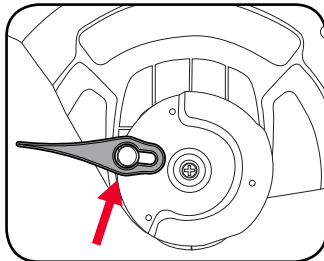

2. Pull the blade outwards so that the small hole is fitted into the mount.

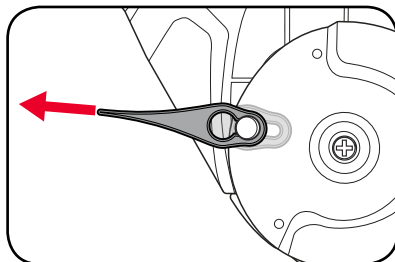

3. To remove the blade push the blade towards the centre of the spindle and then slide off.

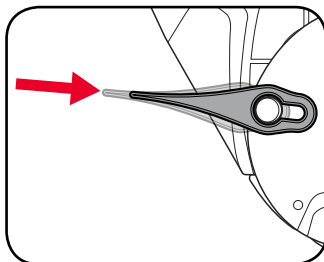

## 2. ADJUSTING THE TRIMMER

### Adjusting the Height

1. Loosen the shaft adjustment collar.

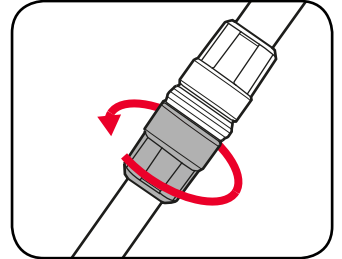

2. Extend to the desired height and then retighten the shaft adjustment collar to secure in place.

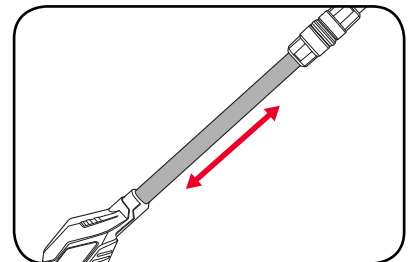

### Adjusting the Secondary Handle

1. Loosen the locking knob.

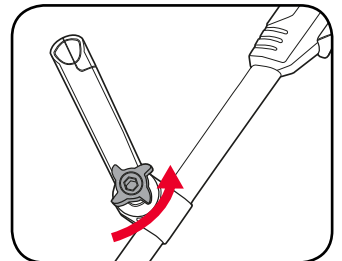

2. Rotate the handle into the desired position and then tighten the locking knob.

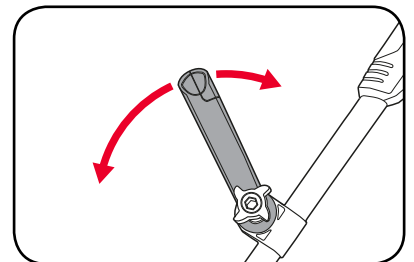

# OPERATION

## 3. CONTROLS & OPERATION

### Inserting & Removing the Battery

1. Align the ribs of the battery with the recess in below the handle and slide in until it clicks into place.

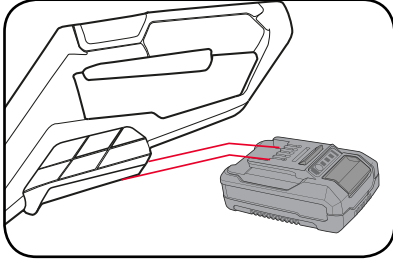

2. To remove, press and hold the battery release tab and then slide out.

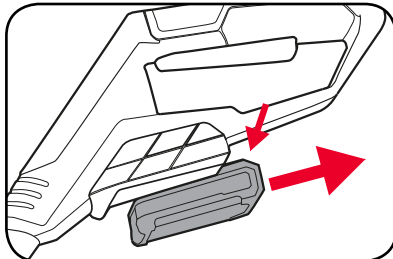

### Switching On and Off

**CAUTION!** BEFORE YOU START THE UNIT, MAKE SURE THAT THE GRASS TRIMMER IS NOT MAKING CONTACT WITH ANY OBJECTS.

1. Squeeze the on/off trigger to start the trimmer.

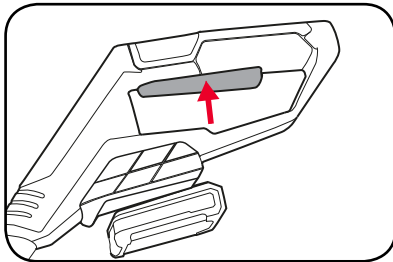

2. To stop the trimmer, release the On/Off trigger.

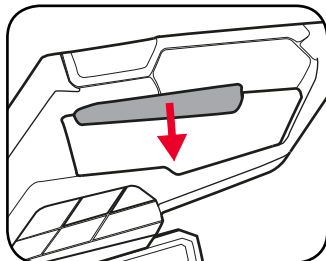

**WARNING!** DO NOT OPERATE THE TRIMMER ON A TREE, ON A LADDER, OR ON A SCAFFOLD, THIS IS EXTREMELY DANGEROUS.



**WARNING!** STONES, PIECES OF METAL AND OTHER OBJECTS CAN BE THROWN OUT AT HIGH SPEED BY THE BLADE.

### Using the Grass Trimmer



**WARNING!** INSPECT THE AREA TO BE TRIMMED AND REMOVE ANY WIRE, CORD OR STRING-LIKE OBJECTS WHICH COULD BECOME ENTANGLED IN THE ROTATING BLADE.

- Hold the trimmer with both handles for best control and balance.

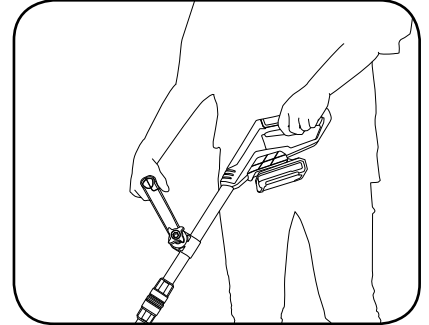

- Move the grass trimmer from side to side as you walk forward, holding it at an angle of approx. 30° (Light cuts are better than heavy cuts as they allow the cut grass to fall away from the cutting head).

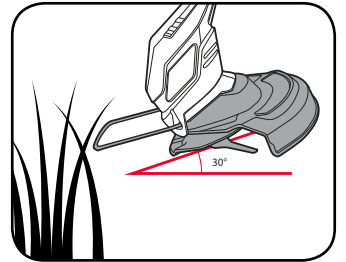

- Several passes will be required to cut long grass.

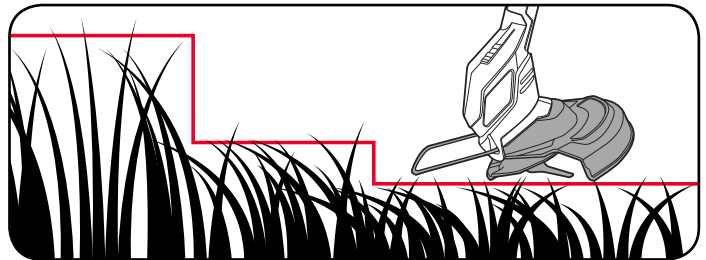

- When finished, release the on/off trigger and allow the motor to come to a complete standstill.

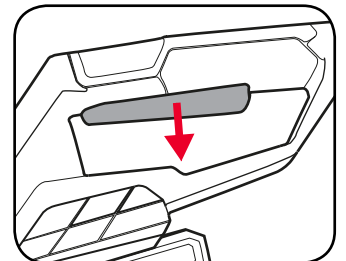

**NOTE:** DO NOT CUT GRASS WHEN WET. (THE BEST RESULTS ARE ACHIEVED ON DRY GRASS.)

**CAUTION!** BYSTANDERS MUST KEEP A MINIMUM SAFE DISTANCE OF 10M AWAY FROM THE TRIMMER WHILE IT IS OPERATING.

# TROUBLESHOOTING

Problem	Cause	Remedy
Trimmer is not starting	Possible clogging	Clean the cutter head of any grass.
	Battery is low in charge	Charge battery
	Battery not inserted properly	Insert battery pack correctly
Trimmer is not operating at full capacity	Possible clogging	Clean the cutter head of any grass.
	Cutting tall grass at ground level.	Make several passes from top down.
Motor stops while operating	Battery has no power	Charge battery
Grass wraps around the shaft and trimmer head.	Cutting tall grass at ground level.	Make several passes from top down.

# MAINTENANCE



**WARNING! ALWAYS ENSURE THE TOOL HAS COMPLETELY STOPPED AND THE BATTERY IS REMOVED PRIOR TO ANY MAINTENANCE.**

## Replacing the Spindle Plate

- Unscrew the countersunk head screw in the centre of the spindle plate, rotate anti-clockwise to remove. Once removed put aside for re-assembly.
- Lift off the spindle plate.
- Mount and fasten the new spindle plate.

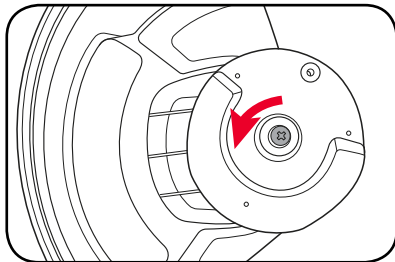

- Keep ventilation slots of the trimmer clean at all times. Periodically clean out the grass from the cutting head and the rim of the blade guard to ensure efficient operation at all times.
- After each use, blow air through the tool housing to ensure it is free from all dust, dirt, etc. Buildup of dust, dirt particles may cause the tool to overheat and shorten the life of the tool.
- If the housing of the trimmer requires cleaning, do not use solvents but a moist soft cloth or soft brush only.
- Never let any liquid get inside the tool, never immerse any part of the tool into liquid.
- No lubrication is necessary as the tool has sealed bearings.
- When not in use, the grass trimmer should be stored in a dry, frost free location not within the reach of children.

Note: Ozito Industries will not be responsible for any damage or injuries caused by the repair of the grass trimmer by an unauthorised person or by mishandling of the grass trimmer. This tool is designed for DIY use - use in commercial or industrial environments will void the warranty.

## Battery protection system

The tool is equipped with the battery protection system, which helps to ensure a long service life.

The output power automatically cuts off during operation when the tool and/or battery are placed under the following situations:

- When the tool is overloaded:**

If this occurs, release the trigger switch and remove causes of overload, then pull the switch trigger again to restart.

- When the remaining battery capacity becomes low:**

Recharge the battery pack.

**Note:** The battery protection system does not in any way damage the tool.

**Note:** The indicated capacity may be lower than the actual level during use or immediately after using the tool.

# CARING FOR THE ENVIRONMENT



Power tools that are no longer usable should not be disposed of with household waste but in an environmentally friendly way. Please recycle where facilities exist. Check with your local council authority for recycling advice.



Recycling packaging reduces the need for landfill and raw materials. Reuse of recycled material decreases pollution in the environment. Please recycle packaging where facilities exist. Check with your local council authority for recycling advice.

# DESCRIPTION OF SYMBOLS

<b>V</b>	Volts	<b>Hz</b>	Hertz
<b>~</b>	Alternating current	<b>W</b>	Watts
<b>dc/---</b>	Direct current	$\emptyset$	Diameter
<b>mA</b>	Milliamperes	<b>n<sub>o</sub></b>	No load speed
<b>/min</b>	Revolutions or reciprocation per minute		Regulator compliance mark
	Warning!		Decibel level
	Read instruction manual		Wear goggles and ear muffs
	Do not use in the rain or leave the grass trimmer outdoors while raining		
		Keep all other persons away from the danger zone.	
	The equipment continues to rotate!		

# SPARE PARTS

Spare Part	Part No.
Blades (pack of 20)	PXCLTA-020
Blades (pack of 50)	PXCLTA-050

**Spare parts can be ordered from the Special Orders Desk at your local Bunnings Warehouse.**

**For further information, or any parts not listed here, visit [www.ozito.com.au](http://www.ozito.com.au) or contact Ozito Customer Service:**

**Australia 1800 069 486**

**New Zealand 0508 069 486**

**E-mail: [enquiries@ozito.com.au](mailto:enquiries@ozito.com.au)**



# ELECTRICAL SAFETY



**WARNING!** When using mains-powered tools, basic safety precautions, including the following, should always be followed to reduce risk of fire, electric shock, personal injury and material damage.

Read the whole manual carefully and make sure you know how to switch the tool off in an emergency, before operating the tool. Save these instructions and other documents supplied with this tool for future reference.

The charger has been designed for 230V and 240V only. Always check that the power supply corresponds to the voltage on the rating plate.

Note: The supply of 230V and 240V on Ozito tools are interchangeable for Australia and New Zealand.



This tool's charger is double insulated therefore no earth wire is required.

If the supply cord is damaged, it must be replaced by an electrician or a power tool repairer in order to avoid a hazard.

**Note:** Double insulation does not take the place of normal safety precautions when operating this tool. The insulation system is for added protection against injury resulting from a possible electrical insulation failure within the tool.

## Using an Extension Lead

Always use an approved extension lead suitable for the power input of this tool. Before use, inspect the extension lead for signs of damage, wear and ageing. Replace the extension lead if damaged or defective.

When using an extension lead on a reel, always unwind the lead completely. Use of an extension lead not suitable for the power input of the tool or which is damaged or defective may result in a risk of fire and electric shock.

The power supply for this product's charger should be protected by a residual current device (rated at 30mA or less). A residual current device reduces the risk of electric shock.



# GENERAL POWER TOOL SAFETY WARNINGS



**WARNING!** Read all safety warnings and all instructions. Failure to follow the warnings and instructions may result in electric shock, fire and/or serious injury.

Save all warnings and instructions for future reference. The term "power tool" in the warnings refers to your mains-operated (corded) power tool or battery-operated (cordless) power tool.

## 1. Work area safety

- Keep work area clean and well lit.** Cluttered or dark areas invite accidents.
- Do not operate power tools in explosive atmospheres, such as in the presence of flammable liquids, gases or dust.** Power tools create sparks which may ignite the dust or fumes.
- Keep children and bystanders away while operating a power tool.** Distractions can cause you to lose control.

## 2. Electrical safety

- Power tool plugs must match the outlet. Never modify the plug in any way. Do not use any adapter plugs with earthed (grounded) power tools.** Unmodified plugs and matching outlets will reduce risk of electric shock.
- Avoid body contact with earthed or grounded surfaces, such as pipes, radiators, ranges and refrigerators.** There is an increased risk of electric shock if your body is earthed or grounded.
- Do not expose power tools to rain or wet conditions.** Water entering a power tool will increase the risk of electric shock.
- Do not abuse the cord. Never use the cord for carrying, pulling or unplugging the power tool. Keep cord away from heat, oil, sharp edges or moving parts.** Damaged or entangled cords increase the risk of electric shock.
- When operating a power tool outdoors, use an extension cord suitable for outdoor use.** Use of a cord suitable for outdoor use reduces the risk of electric shock.
- If operating a power tool in a damp location is unavoidable, use a residual current device (RCD) protected supply.** Use of an RCD reduces the risk of electric shock.

## 3. Personal safety

- Stay alert, watch what you are doing and use common sense when operating a power tool. Do not use a power tool while you are tired or under the influence of drugs, alcohol or medication.** A moment of inattention while operating power tools may result in serious personal injury.
- Use personal protective equipment. Always wear eye protection.** Protective equipment such as dust mask, non-skid safety shoes, hard hat, or hearing protection used for appropriate conditions will reduce personal injuries.
- Prevent unintentional starting. Ensure the switch is in the off-position before connecting to power source and/or battery pack, picking up or carrying the tool.** Carrying power tools with your finger on the switch or energising power tools that have the switch on invites accidents.
- Remove any adjusting key or wrench before turning the power tool on.** A wrench or a key left attached to a rotating part of the power tool may result in personal injury.
- Do not overreach. Keep proper footing and balance at all times.** This enables better control of the power tool in unexpected situations.

- Dress properly. Do not wear loose clothing or jewellery. Keep your hair, clothing and gloves away from moving parts.** Loose clothes, jewellery or long hair can be caught in moving parts.

- If devices are provided for the connection of dust extraction and collection facilities, ensure these are connected and properly used.** Use of dust collection can reduce dust-related hazards.

## 4. Power tool use and care

- Do not force the power tool. Use the correct power tool for your application.** The correct power tool will do the job better and safer at the rate for which it was designed.
- Do not use the power tool if the switch does not turn it on and off.** Any power tool that cannot be controlled with the switch is dangerous and must be repaired.
- Disconnect the plug from the power source and/or the battery pack from the power tool before making any adjustments, changing accessories, or storing power tools.** Such preventive safety measures reduce the risk of starting the power tool accidentally.
- Store idle power tools out of the reach of children and do not allow persons unfamiliar with the power tool or these instructions to operate the power tool.** Power tools are dangerous in the hands of untrained users.
- Maintain power tools. Check for misalignment or binding of moving parts, breakage of parts and any other condition that may affect the power tool's operation. If damaged, have the power tool repaired before use.** Many accidents are caused by poorly maintained power tools.
- Keep cutting tools sharp and clean.** Properly maintained cutting tools with sharp cutting edges are less likely to bind and are easier to control.
- Use the power tool, accessories and tool bits etc. in accordance with these instructions, taking into account the working conditions and the work to be performed.** Use of the power tool for operations different from those intended could result in a hazardous situation.

## 5. Battery tool use and care

- Recharge only with the charger specified by the manufacturer.** A charger that is suitable for one type of battery pack may create a risk of fire when used with another battery pack.
- Use power tools only with specifically designated battery packs.** Use of any other battery packs may create a risk of injury and fire.
- When battery pack is not in use, keep it away from other metal objects, like paper clips, coins, keys, nails, screws or other small metal objects, that can make a connection from one terminal to another.** Shorting the battery terminals together may cause burns or a fire.
- Under abusive conditions, liquid may be ejected from the battery; avoid contact. If contact accidentally occurs, flush with water. If liquid contacts eyes, additionally seek medical help.** Liquid ejected from the battery may cause irritation or burns.

## 6. Service

- Have your power tool serviced by a qualified repair person using only identical replacement parts.** This will ensure that the safety of the power tool is maintained.



# GRASS TRIMMER SAFETY WARNINGS

**Hold power tool by insulated gripping surfaces, when performing an operation where the cutting accessory may contact hidden wiring.** Cutting accessory contacting a "live" wire may make exposed metal parts of the power tool "live" and could give the operator an electric shock.

**This appliance is not intended for use by persons (including children) with reduced physical, sensory or mental capabilities, or lack of experience and knowledge, unless they have been given supervision or instruction concerning use of the appliance by a person responsible for their safety.**

- Never allow children or people unfamiliar with these instructions to use the grass trimmer.
- Avoid using the grass trimmer, while people, especially children or pets, are nearby.
- Use the grass trimmer only in daylight or good artificial light.
- Never operate the grass trimmer with damaged guards or without guards in place.
- Switch on the grass trimmer only when the hands and feet are away from the cutting head.
- Never fit metal cutting blades.
- Use only the manufacturer's recommended replacement parts and accessories.
- Always remove the battery from the grass trimmer when leaving the grass trimmer unattended.
- Always remove the battery from the grass trimmer before carrying out maintenance or cleaning work.

- Inspect and maintain the grass trimmer regularly. Have the grass trimmer repaired only by an authorized repairer.

- When not in use, store the grass trimmer out of the reach of children.

- Face the cutting head away from yourself, other people and animals while the power is connected to the grass trimmer (especially during operation).

- Remove the battery when changing spools or clearing grass from under the guard.

- Remove the battery from the grass trimmer before making any adjustments.

- Use both handles at all times

- Keep ventilation openings clear of debris. Keep handles dry, clean and free of oil and grease.

- Never reach underneath the grass trimmer (the cutting blade area) until it has completely stopped and the battery has been removed.



**WARNING!** When servicing, use only identical replacement parts. Use of any other parts may create a hazard or cause product damage. To ensure safety and reliability, all repairs should be performed by a qualified service technician.



**WARNING!** This appliance is not intended for use by young or infirm persons unless supervised by a responsible person to ensure that they can use the appliance safely. Children should be supervised to ensure that they do not play with the appliance.



18V LITHIUM ION

# CORDLESS HEDGE TRIMMER

## INSTRUCTION MANUAL

### SPECIFICATIONS

Voltage:	18V
Cutting Speed:	2,200 SPM
Max. Cutting Capacity:	11mm
Blade Length:	460mm
Weight:	2.10kg

[ozito.com.au](http://ozito.com.au)

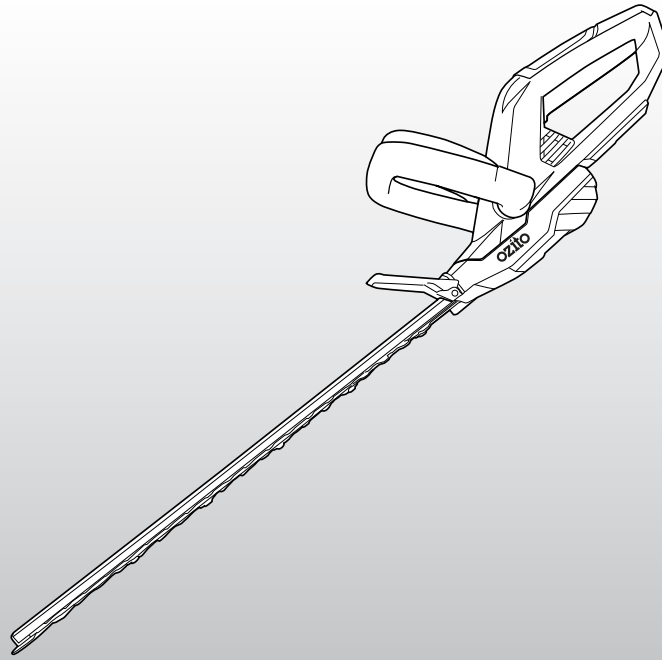

### WHAT'S IN THE BOX



Cordless Hedge Trimmer

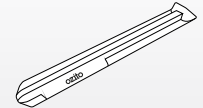

Blade Cover

**5 YEAR**  
REPLACEMENT WARRANTY

PXCHTS-018

## WARRANTY

IN ORDER TO MAKE A CLAIM UNDER THIS WARRANTY YOU MUST RETURN THE PRODUCT TO YOUR NEAREST BUNNINGS WAREHOUSE WITH YOUR BUNNINGS REGISTER RECEIPT. PRIOR TO RETURNING YOUR PRODUCT FOR WARRANTY PLEASE TELEPHONE OUR CUSTOMER SERVICE HELPLINE:

**Australia 1800 069 486**

**New Zealand 0508 069 486**

TO ENSURE A SPEEDY RESPONSE PLEASE HAVE THE MODEL NUMBER AND DATE OF PURCHASE AVAILABLE. A CUSTOMER SERVICE REPRESENTATIVE WILL TAKE YOUR CALL AND ANSWER ANY QUESTIONS YOU MAY HAVE RELATING TO THE WARRANTY POLICY OR PROCEDURE.

### WARNING

The following actions will result in the warranty being void.

- If the tool has been operated on a supply voltage other than that specified on the tool.
- If the tool shows signs of damage or defects caused by or resulting from abuse, accidents or alterations.
- Failure to perform maintenance as set out within the instruction manual.
- If the tool is disassembled or tampered with in any way.

The benefits provided under this warranty are in addition to other rights and remedies which are available to you at law.

Our goods come with guarantees that cannot be excluded at law. You are entitled to a replacement or refund for a major failure and for compensation for any other reasonably foreseeable loss or damage. You are also entitled to have the goods repaired or replaced if the goods fail to be of acceptable quality and the failure does not amount to a major failure.

Generally you will be responsible for all costs associated with a claim under this warranty, however, where you have suffered any additional direct loss as a result of a defective product you may be able to claim such expenses by contacting our customer service helpline above.

### 5 YEAR REPLACEMENT WARRANTY

Your Product is guaranteed for a period of 60 months from the original date of purchase and is intended for DIY (Do It Yourself) use only. If a product is defective it will be replaced in accordance with the terms of this warranty. **Lithium Ion batteries and chargers are covered by a 36 month warranty.** Warranty excludes consumable parts, for example: blade, blade cover.



# KNOW YOUR PRODUCT

## CORDLESS HEDGE TRIMMER

- |                 |                    |
|-----------------|--------------------|
| 1. Impact Guard | 5. Safety Switch   |
| 2. Blade        | 6. On/Off Trigger  |
| 3. Safety Guard | 7. Rear Handle     |
| 4. Front Handle | 8. Battery Seating |

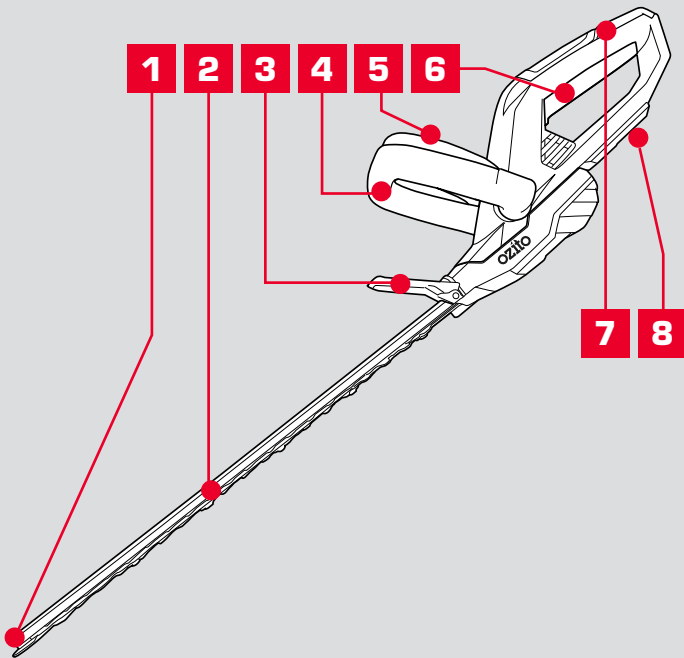

## ACCESSORIES

9. Blade Cover

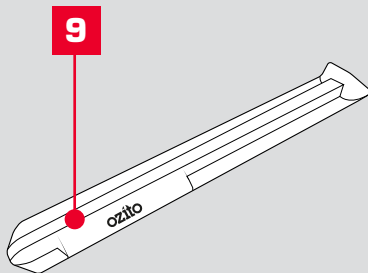

## BATTERY & CHARGER

This tool is compatible with all battery and chargers from Ozito Power X Change Range.

## ONLINE MANUAL

Scan this QR Code with your mobile device to take you to the online manual.

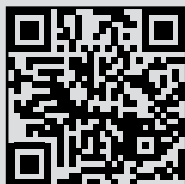

# SETUP & PREPARATION

## 1. ASSEMBLY

**WARNING!** ENSURE THE TOOL IS SWITCHED OFF AND BATTERY DISCONNECTED BEFORE PERFORMING ANY OF THE FOLLOWING TASKS.

### Blade Cover

The blade cover protects the blade when not in use. Simply slide it off the blade before use. Once finished operating, place the cover back over the blade.

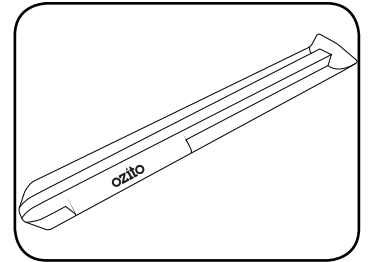

**WARNING!** NEVER START THE HEDGE TRIMMER WHILE THE BLADE COVER IS FITTED.

**WARNING!** WHEN HANDLING THE BLADE ASSEMBLY, WEAR NON-SLIP, HEAVY-DUTY PROTECTIVE GLOVES. DO NOT PLACE YOUR HAND OR FINGERS BETWEEN BLADES OR IN ANY POSITION WHERE THEY COULD GET PINCHED OR CUT. NEVER TOUCH BLADES OR SERVICE THE UNIT WITH THE BATTERY PACK INSTALLED.

### Safety Guard

Ensure the safety guard is fitted securely onto the hedge trimmer before use. Tighten the screws on either side if necessary.

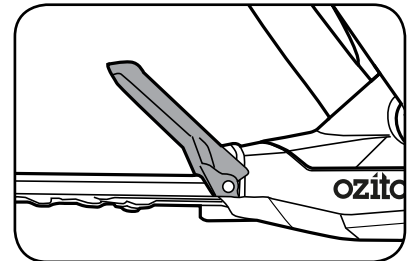

**WARNING!** NEVER USE THE HEDGE TRIMMING UNLESS THE SAFETY GUARD IS FITTED.

**5 YEAR**  
REPLACEMENT WARRANTY

# OPERATION

## 2. INSERTING & REMOVING THE BATTERY

### Inserting the Battery into the Hedge Trimmer

1. Align the ribs of the battery with the recess in below the handle.

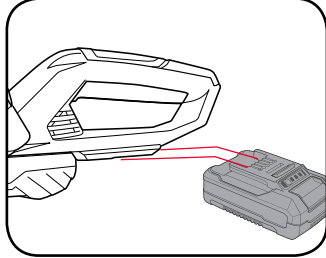

2. Slide the battery in so that it clicks into place.

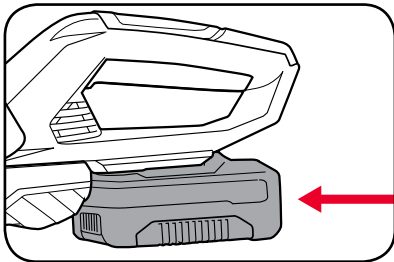

### Removing the Battery from the Hedge Trimmer

1. Press and hold the battery release tab to release the battery.

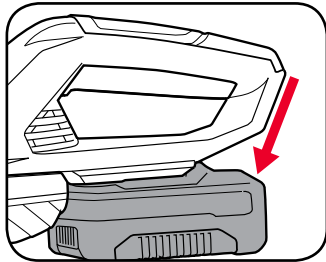

2. Slide the battery out.

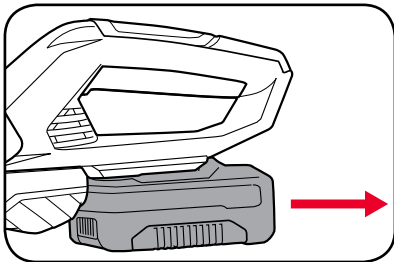

## 3. CONTROLS

### Switching On and Off

1. Press and hold the safety switch.

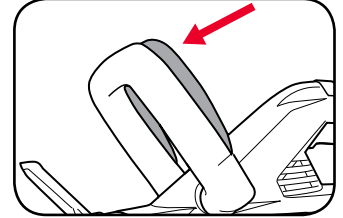

2. To start the hedge trimmer, squeeze the on/off trigger.

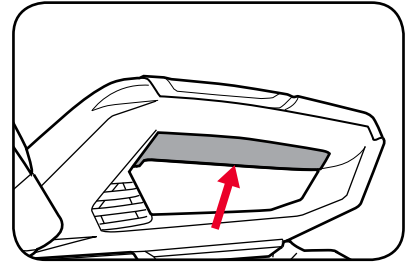

3. To stop operating, release the on/off trigger.



**WARNING! DO NOT USE ANY ATTACHMENTS OR ACCESSORIES NOT RECOMMENDED BY THE MANUFACTURER OF THIS PRODUCT, AS IT CAN RESULT IN SERIOUS PERSONAL INJURY.**

## 4. OPERATION

**WARNING!** CLEAR THE AREA TO BE CUT BEFORE EACH USE. REMOVE ALL OBJECTS, SUCH AS CORDS, LIGHTS, WIRE, OR STRING WHICH CAN BECOME ENTANGLED IN THE CUTTING BLADE AND CREATE A RISK OF SERIOUS PERSONAL INJURY.

### Top cutting

Use a wide sweeping motion. A slight downward tilt of the cutting blades in the direction of motion gives the best cutting results.

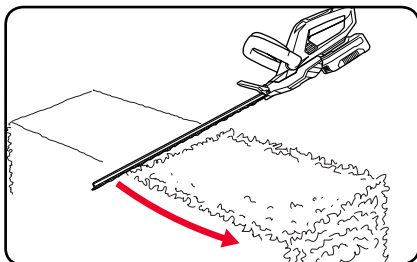

### Side cutting

When trimming the sides of the hedge, begin at the bottom and cut upwards. Trim the side of a hedge so that it will be slightly narrower at the top. This shape will expose more of the hedge, resulting in a more uniform growth.

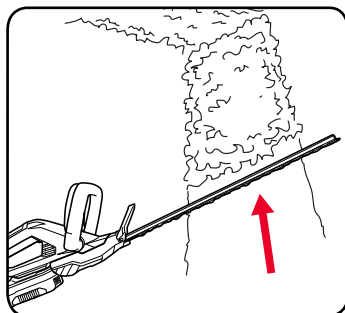

**WARNING!** IF THE BLADE JAMS ON ANY ELECTRICAL CORD OR LINE, DO NOT TOUCH THE BLADE! IT CAN BECOME ELECTRICALLY LIVE AND VERY DANGEROUS. CONTINUE TO HOLD THE HEDGE TRIMMER BY THE INSULATED REAR HANDLE OR LAY IT DOWN AND AWAY FROM YOU IN A SAFE MANNER. DISCONNECT THE ELECTRICAL SERVICE TO THE DAMAGED LINE OR CORD BEFORE ATTEMPTING TO FREE THE BLADE. FAILURE TO HEED THIS WARNING MAY RESULT IN SERIOUS PERSONAL INJURY OR POSSIBLE DEATH.

# MAINTENANCE



**WARNING!** ALWAYS ENSURE THE TOOL HAS COMPLETELY STOPPED AND THE BATTERY IS REMOVED PRIOR TO ANY MAINTENANCE.

## Sharpening the cutting blade

1. Start and stop your hedge trimmer until the cutter blade and the guard are slightly offset.

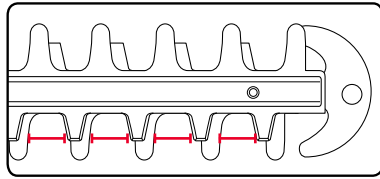

2. Remove the battery pack from your hedge trimmer.

3. Clamp the blade assembly in a vise and file the exposed cutting surface of each blade tooth. Remove as little material as possible.

4. Remove the hedge trimmer from the vise and insert the battery pack. Repeat steps 1-3 for the unsharpened edges of the blade teeth.

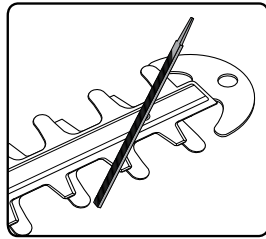

**Note:** Do not operate your hedge trimmer with dull or damaged cutting blades. This may cause overload and will give unsatisfactory cutting results.

## Lubricating the blade

For best operation and longer blade life, lubricate the hedge trimmer blade with light weight machine oil before and after each use.

1. Remove the battery pack from the hedge trimmer.

2. Lay the hedge trimmer on a flat surface. Apply a light weight machine oil along the edge of the top blade.

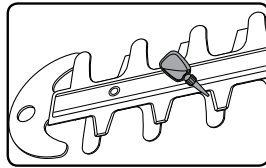

**WARNING!** DO NOT OIL WHILE THE HEDGE TRIMMER IS RUNNING.

## Cleaning and Storage

- Keep air intake clean and air vents free of debris to avoid overheating the motor.
- Do not use cleaning agents to clean the plastic parts of the tool. A mild detergent on a damp cloth is recommended. Water must never come into contact with the tool.
- If the trimmer vibrates abnormally, stop motor immediately. Abnormal vibration usually indicates a mechanical problem continued operation could lead to injury or damage.
- Always place the blade cover on the blade before storing or transporting the hedge trimmer. Use caution to avoid the sharp teeth of the blade.
- Store the hedge trimmer indoors, in a dry place that is inaccessible to children.

Note: Ozito Industries will not be responsible for any damage or injuries caused by the repair of the trimmer by an unauthorised person or by mishandling of the trimmer. This tool is designed for DIY use - use in commercial or industrial environments will void the warranty.

# TROUBLESHOOTING

Problem	Cause	Remedy
Trimmer is not starting	Possible clogging	Clean the trimmer blade of any leaves or debris.
	Battery is low in charge	Charge battery
	Battery not inserted properly	Insert battery pack correctly
Trimmer is not operating at full capacity	Possible clogging	Clean the trimmer blade of any leaves or debris.
Motor stops while trimming	Battery has no power	Charge battery

# DESCRIPTION OF SYMBOLS

<b>V</b>	Volts	<b>Hz</b>	Hertz
<b>~</b>	Alternating current	<b>W</b>	Watts
<b>dc/---</b>	Direct current	<b>∅</b>	Diameter
<b>mA</b>	Milliamperes	<b>No</b>	No load speed
<b>/min</b>	Revolutions or reciprocation per minute		Double insulated
	Regulator compliance mark		Warning
	Read instruction manual		
	Do not use in the rain or leave the trimmer outdoors while raining.		
		Keep bystanders away. Do not operate whilst people especially children or pets are in the area.	

# CARING FOR THE ENVIRONMENT



Power tools that are no longer usable should not be disposed of with household waste but in an environmentally friendly way. Please recycle where facilities exist. Check with your local council authority for recycling advice.



Recycling packaging reduces the need for landfill and raw materials. Reuse of recycled material decreases pollution in the environment. Please recycle packaging where facilities exist. Check with your local council authority for recycling advice.



# ELECTRICAL SAFETY



**WARNING!** When using mains-powered tools, basic safety precautions, including the following, should always be followed to reduce risk of fire, electric shock, personal injury and material damage.

Read the whole manual carefully and make sure you know how to switch the tool off in an emergency, before operating the tool. Save these instructions and other documents supplied with this tool for future reference.

The charger has been designed for 230V and 240V only. Always check that the power supply corresponds to the voltage on the rating plate.

Note: The supply of 230V and 240V on Ozito tools are interchangeable for Australia and New Zealand.



This tool's charger is double insulated in accordance with AS/NZS 60745-1; therefore no earth wire is required.

If the supply cord is damaged, it must be replaced by an electrician or a power tool repairer in order to avoid a hazard.

**Note:** Double insulation does not take the place of normal safety precautions when operating this tool. The insulation system is for added protection against injury resulting from a possible electrical insulation failure within the tool.

## Using an Extension Lead

Always use an approved extension lead suitable for the power input of this tool. Before use, inspect the extension lead for signs of damage, wear and ageing. Replace the extension lead if damaged or defective.

When using an extension lead on a reel, always unwind the lead completely. Use of an extension lead not suitable for the power input of the tool or which is damaged or defective may result in a risk of fire and electric shock.

The power supply for this product's charger should be protected by a residual current device (rated at 30mA or less). A residual current device reduces the risk of electric shock.



# GENERAL POWER TOOL SAFETY WARNINGS



**WARNING!** Read all safety warnings and all instructions. Failure to follow the warnings and instructions may result in electric shock, fire and/or serious injury.

Save all warnings and instructions for future reference. The term "power tool" in the warnings refers to your mains-operated (corded) power tool or battery-operated (cordless) power tool.

## 1. Work area safety

- Keep work area clean and well lit.** Cluttered or dark areas invite accidents.
- Do not operate power tools in explosive atmospheres, such as in the presence of flammable liquids, gases or dust.** Power tools create sparks which may ignite the dust or fumes.
- Keep children and bystanders away while operating a power tool.** Distractions can cause you to lose control.

## 2. Electrical safety

- Power tool plugs must match the outlet. Never modify the plug in any way. Do not use any adapter plugs with earthed (grounded) power tools.** Unmodified plugs and matching outlets will reduce risk of electric shock.
- Avoid body contact with earthed or grounded surfaces, such as pipes, radiators, ranges and refrigerators.** There is an increased risk of electric shock if your body is earthed or grounded.
- Do not expose power tools to rain or wet conditions.** Water entering a power tool will increase the risk of electric shock.
- Do not abuse the cord. Never use the cord for carrying, pulling or unplugging the power tool. Keep cord away from heat, oil, sharp edges or moving parts.** Damaged or entangled cords increase the risk of electric shock.
- When operating a power tool outdoors, use an extension cord suitable for outdoor use.** Use of a cord suitable for outdoor use reduces the risk of electric shock.
- If operating a power tool in a damp location is unavoidable, use a residual current device (RCD) protected supply.** Use of an RCD reduces the risk of electric shock.

## 3. Personal safety

- Stay alert, watch what you are doing and use common sense when operating a power tool. Do not use a power tool while you are tired or under the influence of drugs, alcohol or medication.** A moment of inattention while operating power tools may result in serious personal injury.
- Use personal protective equipment. Always wear eye protection.** Protective equipment such as dust mask, non-skid safety shoes, hard hat, or hearing protection used for appropriate conditions will reduce personal injuries.
- Prevent unintentional starting. Ensure the switch is in the off-position before connecting to power source and/or battery pack, picking up or carrying the tool.** Carrying power tools with your finger on the switch or energising power tools that have the switch on invites accidents.
- Remove any adjusting key or wrench before turning the power tool on.** A wrench or a key left attached to a rotating part of the power tool may result in personal injury.
- Do not overreach. Keep proper footing and balance at all times.** This enables better control of the

power tool in unexpected situations.

- Dress properly. Do not wear loose clothing or jewellery. Keep your hair, clothing and gloves away from moving parts.** Loose clothes, jewellery or long hair can be caught in moving parts.
  - If devices are provided for the connection of dust extraction and collection facilities, ensure these are connected and properly used.** Use of dust collection can reduce dust-related hazards.
- ## 4. Power tool use and care
- Do not force the power tool. Use the correct power tool for your application.** The correct power tool will do the job better and safer at the rate for which it was designed.
  - Do not use the power tool if the switch does not turn it on and off.** Any power tool that cannot be controlled with the switch is dangerous and must be repaired.
  - Disconnect the plug from the power source and/or the battery pack from the power tool before making any adjustments, changing accessories, or storing power tools.** Such preventive safety measures reduce the risk of starting the power tool accidentally.
  - Store idle power tools out of the reach of children and do not allow persons unfamiliar with the power tool or these instructions to operate the power tool.** Power tools are dangerous in the hands of untrained users.
  - Maintain power tools. Check for misalignment or binding of moving parts, breakage of parts and any other condition that may affect the power tool's operation. If damaged, have the power tool repaired before use.** Many accidents are caused by poorly maintained power tools.
  - Keep cutting tools sharp and clean.** Properly maintained cutting tools with sharp cutting edges are less likely to bind and are easier to control.
  - Use the power tool, accessories and tool bits etc. in accordance with these instructions, taking into account the working conditions and the work to be performed.** Use of the power tool for operations different from those intended could result in a hazardous situation.
- ## 5. Battery tool use and care
- Recharge only with the charger specified by the manufacturer.** A charger that is suitable for one type of battery pack may create a risk of fire when used with another battery pack.
  - Use power tools only with specifically designated battery packs.** Use of any other battery packs may create a risk of injury and fire.
  - When battery pack is not in use, keep it away from other metal objects, like paper clips, coins, keys, nails, screws or other small metal objects, that can make a connection from one terminal to another.** Shorting the battery terminals together may cause burns or a fire.
  - Under abusive conditions, liquid may be ejected from the battery; avoid contact. If contact accidentally occurs, flush with water. If liquid contacts eyes, additionally seek medical help.** Liquid ejected from the battery may cause irritation or burns.
- ## 6. Service
- Have your power tool serviced by a qualified repair person using only identical replacement parts.** This will ensure that the safety of the power tool is maintained.



# HEDGE TRIMMER SAFETY WARNINGS

- Keep all parts of the body away from the cutter blade.** Do not remove cut material or hold material to be cut when blades are moving. Make sure the switch is off when clearing jammed material. A moment of inattention while operating the hedge trimmer may result in serious personal injury.
- Carry the hedge trimmer by the handle with the cutter blade stopped.** When transporting or storing the hedge trimmer always fit the cutting device cover. Proper handling of the hedge trimmer will reduce possible personal injury from the cutter blades.
- Hold the power tool by insulated gripping surfaces only, because the cutter blade may contact hidden wiring.** Cutter blades contacting a "live" wire may make exposed metal parts of the power tool "live" and could give the operator an electric shock.
- Perform visual inspection on the hedge being trimmed.** To ensure no wire fences or foreign objects that the hedge trimmer may contact during operation.
  - Never allow children or people unfamiliar with these instructions to use the Hedge Trimmer.
  - Avoid using the Hedge Trimmer, while people, especially children or pets, are nearby.
  - Use the Hedge Trimmer only in daylight or good artificial light.
  - Never operate the Hedge Trimmer with damaged guards or without guards in place.
  - Switch on the Hedge Trimmer only when the hands and feet are away from the cutting blades.
  - Use only the manufacturer's recommended replacement parts and accessories.
  - Always remove the battery from the Hedge Trimmer when leaving the Hedge Trimmer unattended.
  - Always remove the battery from the Hedge Trimmer before carrying out maintenance or cleaning work.
  - Inspect and maintain the Hedge Trimmer regularly. Have the Hedge Trimmer repaired only by an authorized repairer.
  - When not in use, store the Hedge Trimmer out of the reach of children.
  - Face the cutting blades away from yourself, other people and animals while the power is connected to the Hedge Trimmer (especially during operation).
  - Use both handles.
  - Keep ventilation openings clear of debris. Keep handles dry, clean and free of oil and grease.
  - Never reach underneath the Hedge Trimmer (the cutting blade area) until it has completely stopped and the power has been disconnected.



**WARNING!** When servicing, use only identical replacement parts. Use of any other parts may create a hazard or cause product damage. To ensure safety and reliability, all repairs should be performed by a qualified service technician.



**WARNING!** This appliance is not intended for use by young or infirm persons unless supervised by a responsible person to ensure that they can use the appliance safely. Young children should be supervised to ensure that they do not play with the appliance.

# SPARE PARTS

**Spare parts can be ordered from the Special Orders Desk at your local Bunnings Warehouse.**

**For further information, or any parts not listed here, visit [www.ozito.com.au](http://www.ozito.com.au) or contact Ozito Customer Service:**

**Australia 1800 069 486**

**New Zealand 0508 069 486**

**E-mail: [enquires@ozito.com.au](mailto:enquires@ozito.com.au)**





18V LITHIUM ION

# CORDLESS BLOWER

## INSTRUCTION MANUAL

### SPECIFICATIONS

Voltage:	18V
No Load Speed:	12,000/min
Max. Air Speed:	210km/hr
Weight:	1.35kg

[ozito.com.au](http://ozito.com.au)

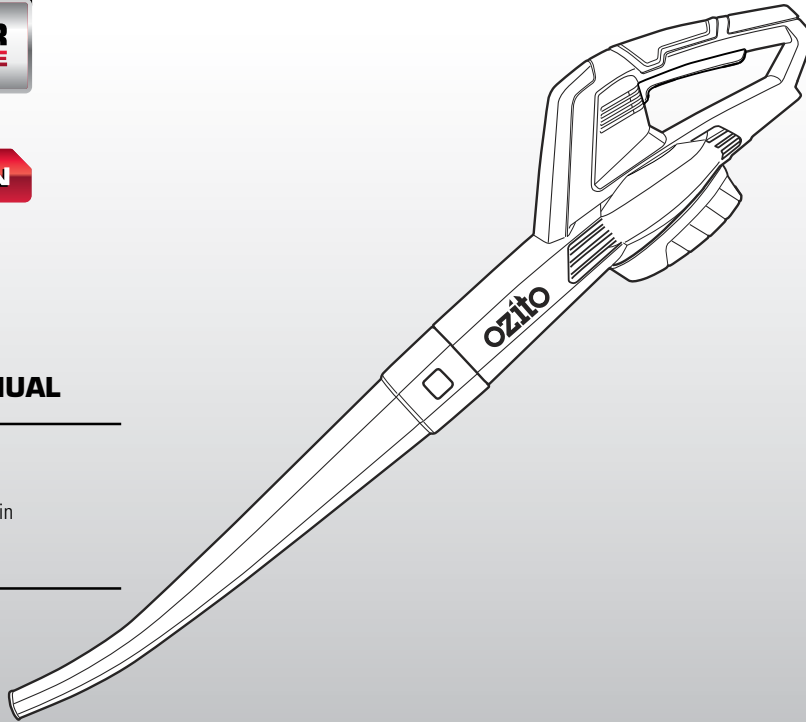

### STANDARD EQUIPMENT



Cordless Blower



Blower Tube

**5 YEAR**  
REPLACEMENT WARRANTY

**PXCBLK-018**

## WARRANTY

IN ORDER TO MAKE A CLAIM UNDER THIS WARRANTY YOU MUST RETURN THE PRODUCT TO YOUR NEAREST BUNNINGS WAREHOUSE WITH YOUR BUNNINGS REGISTER RECEIPT. PRIOR TO RETURNING YOUR PRODUCT FOR WARRANTY PLEASE TELEPHONE OUR CUSTOMER SERVICE HELPLINE:

**Australia 1800 069 486**  
**New Zealand 0508 069 486**

TO ENSURE A SPEEDY RESPONSE PLEASE HAVE THE MODEL NUMBER AND DATE OF PURCHASE AVAILABLE. A CUSTOMER SERVICE REPRESENTATIVE WILL TAKE YOUR CALL AND ANSWER ANY QUESTIONS YOU MAY HAVE RELATING TO THE WARRANTY POLICY OR PROCEDURE.

### WARNING

The following actions will result in the warranty being void.

- If the tool has been operated on a supply voltage other than that specified on the tool.
- If the tool shows signs of damage or defects caused by or resulting from abuse, accidents or alterations.
- Failure to perform maintenance as set out within the instruction manual.
- If the tool is disassembled or tampered with in any way.

The benefits provided under this warranty are in addition to other rights and remedies which are available to you at law.

Our goods come with guarantees that cannot be excluded at law. You are entitled to a replacement or refund for a major failure and for compensation for any other reasonably foreseeable loss or damage. You are also entitled to have the goods repaired or replaced if the goods fail to be of acceptable quality and the failure does not amount to a major failure.

Generally you will be responsible for all costs associated with a claim under this warranty, however, where you have suffered any additional direct loss as a result of a defective product you may be able to claim such expenses by contacting our customer service helpline above.

### 5 YEAR REPLACEMENT WARRANTY

Your Product is guaranteed for a period of 60 months from the original date of purchase and is intended for DIY (Do It Yourself) use only. If a product is defective it will be replaced in accordance with the terms of this warranty. **Lithium Ion batteries and chargers are covered by a 36 month warranty.** Warranty excludes consumable parts, for example: blower tube.

# KNOW YOUR PRODUCT

## CORDLESS BLOWER

- |                         |                 |
|-------------------------|-----------------|
| 1 Blow Tube             | 3 ON/OFF Switch |
| 2 Blow Tube Release Tab | 4 Handle        |

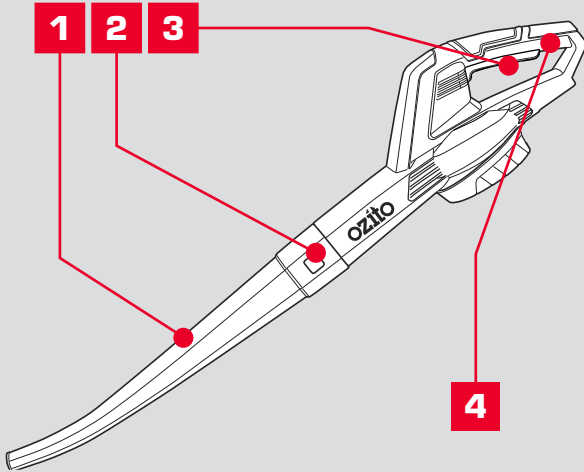

## BATTERY & CHARGER

This tool is compatible with all battery and chargers from the Ozito Power X Change Range.

### ONLINE MANUAL

Scan this QR Code with your mobile device to take you to the online manual.

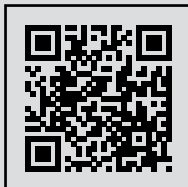

# SETUP & PREPARATION

## 1. ASSEMBLY



**WARNING!** ENSURE THE TOOL IS SWITCHED OFF AND BATTERY DISCONNECTED BEFORE PERFORMING ANY OF THE FOLLOWING TASKS.

### Fitting the Blower Tube

1. Align the blower tube with the outlet of the blower.

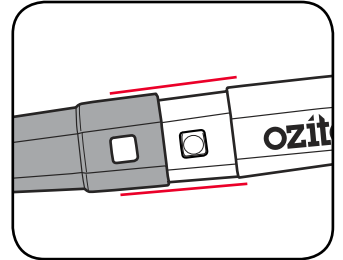

2. Push the blower tube onto the blower until it clicks into place.

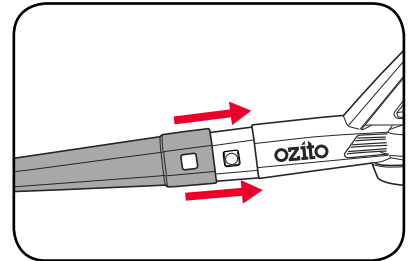

3. To remove the blower tube, press the blower tube release tab while pulling the tube away from the housing.

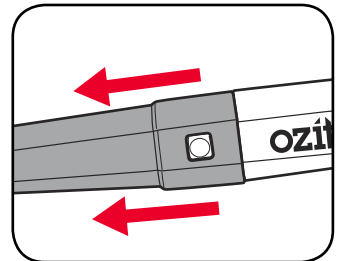

**5 YEAR**  
REPLACEMENT WARRANTY

# OPERATION

## 2. INSERTING & REMOVING THE BATTERY

### Inserting the Battery Pack

1. Align the ribs of the battery with the recess in below the handle.

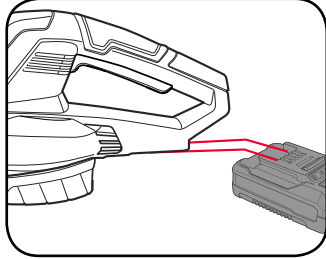

2. Slide the battery in so that it clicks into place.

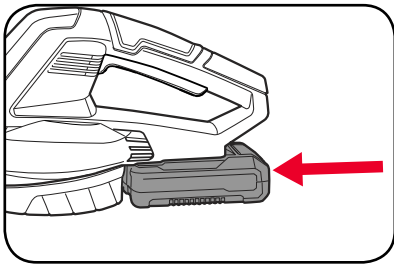

### Removing a Battery from the Blower

1. Press and hold the battery release tab to release the battery.

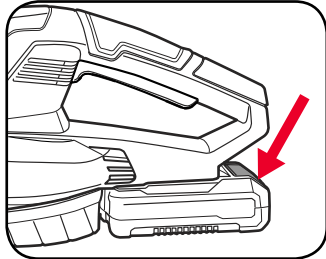

2. Slide the battery out.

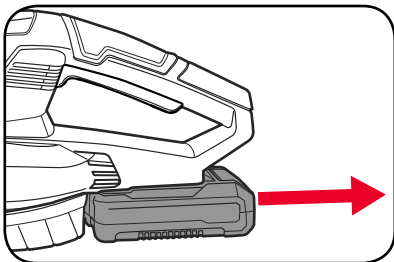

## 3. CONTROLS



**WARNING!** DO NOT USE THE BLOWER WITH ANY TYPE OF ACCESSORY OR ATTACHMENT. SUCH USAGE MIGHT BE HAZARDOUS.

### Switching On and Off

1. To start the blower squeeze the on/off switch.
2. To stop the blower release the on/off switch.

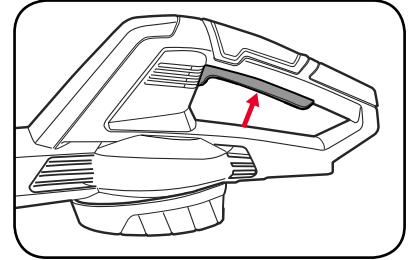

**WARNING!** DO NOT PUT PART OF YOUR BODY SUCH AS HANDS AND FINGERS IN THE VACUUM OPENING OR EXHAUST OPENING.



**WARNING!** DO NOT USE ANY ATTACHMENTS OR ACCESSORIES NOT RECOMMENDED BY THE MANUFACTURER OF THIS PRODUCT, AS IT CAN RESULT IN SERIOUS PERSONAL INJURY.

## 4. OPERATION



**WARNING!** DO NOT SWITCH THE BLOWER ON IN ENCLOSED OR POORLY VENTILATED SPACES OR IN THE PRESENCE OF FLAMMABLE AND/OR EXPLOSIVE LIQUIDS, GASES AND POWDERS.

### Blowing

The blower is ideal for blowing leaves, grass clippings and other debris.

Hold the blower firmly, squeeze the on/off switch, point the jet of air in front of you and move forward slowly. Move the blower from side to side, with the tube several inches above the ground.

Be careful where you point the jet of air as it can move heavy material and cause injury or damage to bystanders.

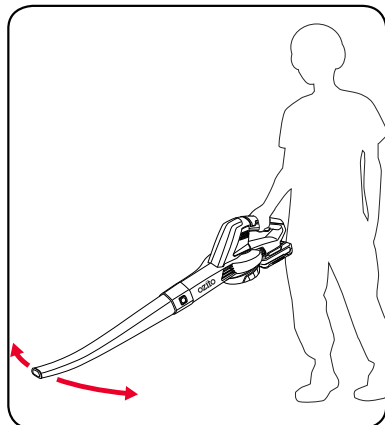

**Note:** Be aware of other people and animals in the area where you are to be operating the blower.

**Note:** Avoid collisions with hard objects which could damage your machine.

# BATTERY PROTECTION SYSTEM

The tool is equipped with the battery protection system, which helps to ensure a long service life.

The output power automatically cuts off during operation when the tool and/or battery are placed under the following situations:

- **When the tool is overloaded:**

If this occurs, release the trigger switch and remove causes of overload, then pull the switch trigger again to restart.

- **When the remaining battery capacity becomes low:**

Recharge the battery pack.

**Note:** The battery protection system does not in any way damage the tool.

**Note:** The indicated capacity may be lower than the actual level during use or immediately after using the tool.

# MAINTENANCE



**WARNING! ALWAYS ENSURE THE TOOL HAS COMPLETELY STOPPED AND THE BATTERY IS REMOVED PRIOR TO ANY MAINTENANCE.**

- Keep air intake clean and air vents free of debris to avoid overheating the motor.
- Do not use cleaning agents to clean the plastic parts of the tool. A mild detergent on a damp cloth is recommended. Water must never come into contact with the tool.
- If the blower vibrates abnormally, stop motor immediately. Abnormal vibration usually indicates a mechanical problem continued operation could lead to injury or damage.
- No lubrication is necessary as the motor is equipped with lifetime-lubricated bearings.

Note: Ozito Industries will not be responsible for any damage or injuries caused by the repair of the blower by an unauthorised person or by mishandling of the blower. This tool is designed for DIY use - use in commercial or industrial environments will void the warranty.

# TROUBLESHOOTING

Problem	Cause	Remedy
Blower is not starting	Possible clogging	Clean the blower tube and blower outlet of any leaves or debris.
	Battery is low in charge	Charge battery
	Battery not inserted properly	Insert battery pack correctly
Blower is not operating at full capacity	Possible clogging	Clean the blower tube and blower outlet of any leaves or debris.
Motor stops while blowing	Battery has no power	Charge battery

# SPARE PARTS

Spare parts can be ordered from the Special Orders Desk at your local Bunnings Warehouse.

For further information, or any parts not listed here, visit

[www.ozito.com.au](http://www.ozito.com.au) or contact Ozito Customer Service:

Australia 1800 069 486

New Zealand 0508 069 486

E-mail: [enquiries@ozito.com.au](mailto:enquiries@ozito.com.au)



# BATTERY AND CHARGER SAFETY WARNINGS

THIS MANUAL CONTAINS IMPORTANT SAFETY AND OPERATING INSTRUCTIONS FOR YOUR BATTERY CHARGER.

1. Before using the charger read all instructions and cautionary markings on the charger, battery pack and the product using the battery pack.
2. This charger is not intended for any uses other than charging rechargeable batteries. Any other use may result in risk of fire, electric shock or electrocution.
3. Do not place any object on top of the charger or place the charger on a soft surface that may result in excessive internal heat. Place the charger in a position away from any heat source.
4. To reduce risk of damage to the electric plug and cord, pull by the plug rather than the cord when disconnecting the charger.
5. Make sure the cord is located so that it will not be stepped on, tripped over, or otherwise subjected to damage or stress.
6. An extension cord should not be used unless absolutely necessary. Use of an improper extension cord could result in the risk of fire, electric shock or electrocution.
7. Do not operate the charger if it has received a sharp blow, been dropped or otherwise damaged in any way. Have it checked by an electrician or power tool repairer.
8. Do not disassemble charger. Take it to an electrician or power tool repairer when service or repair is required. Incorrect reassembly may result in a risk of electric shock, electrocution or fire.
9. To reduce risk of electric shock, unplug the charger from the outlet before attempting any cleaning. Removing the battery pack will not reduce this risk.
10. Never attempt to connect 2 chargers together.
11. DO NOT store or use the tool and battery pack in locations where the temperature may reach or exceed 40°C (such as inside sheds or metal buildings in summer).
12. The charger is designed to operate on standard household electrical power (240 volts). Do not attempt to use it on any other voltage!
13. The battery pack is not fully charged out of the carton. First read the safety instructions and then follow the charging notes and procedures.
14. The longest life and best performance can be obtained if the battery pack is charged when the air temperature is between 18 - 24°C. Do not charge the battery pack in an air temperature below 10°C or above 40°C. This is important and will prevent damage to the battery pack.
15. Do not incinerate the battery pack even if it is seriously damaged or is completely worn out. The battery can explode in a fire.
16. Never attempt to open the battery pack for any reason. If the plastic housing of the battery pack breaks or cracks, immediately discontinue use and do not recharge.
17. During charging, the battery must be placed in a well ventilated area.

# DESCRIPTION OF SYMBOLS

<b>V</b>	Volts	<b>Hz</b>	Hertz
<b>~</b>	Alternating current	<b>W</b>	Watts
<b>dc/---</b>	Direct current	<b>∅</b>	Diameter
<b>mA</b>	Milliamperes	<b>no</b>	No load speed
<b>/min</b>	Revolutions or reciprocation per minute		Double insulated
	Read instruction manual		Warning
	Regulator compliance mark		Wear eye and ear protection.
	Do not use in the rain or leave the blower outdoors while raining.		
	Keep bystanders away. Do not operate whilst people especially children or pets are in the area.		

# CARING FOR THE ENVIRONMENT



Power tools that are no longer usable should not be disposed of with household waste but in an environmentally friendly way. Please recycle where facilities exist. Check with your local council authority for recycling advice.



Recycling packaging reduces the need for landfill and raw materials. Reuse of recycled material decreases pollution in the environment. Please recycle packaging where facilities exist. Check with your local council authority for recycling advice.





# ELECTRICAL SAFETY



**WARNING!** When using mains-powered tools, basic safety precautions, including the following, should always be followed to reduce risk of fire, electric shock, personal injury and material damage.

Read the whole manual carefully and make sure you know how to switch the tool off in an emergency, before operating the tool. Save these instructions and other documents supplied with this tool for future reference.

The charger has been designed for 230V and 240V only. Always check that the power supply corresponds to the voltage on the rating plate.

Note: The supply of 230V and 240V on Ozito tools are interchangeable for Australia and New Zealand.



This tool's charger is double insulated in therefore no earth wire is required.

If the supply cord is damaged, it must be replaced by an electrician or a power tool repairer in order to avoid a hazard.

**Note:** Double insulation does not take the place of normal safety precautions when operating this tool. The insulation system is for added protection against injury resulting from a possible electrical insulation failure within the tool.

The power supply for this product's charger should be protected by a residual current device (rated at 30mA or less). A residual current device reduces the risk of electric shock.



# GENERAL POWER TOOL SAFETY WARNINGS



**WARNING!** Read all safety warnings and all instructions. Failure to follow the warnings and instructions may result in electric shock, fire and/or serious injury.

Save all warnings and instructions for future reference. The term "power tool" in the warnings refers to your mains-operated (corded) power tool or battery-operated (cordless) power tool.

## 1. Work area safety

- Keep work area clean and well lit.** Cluttered or dark areas invite accidents.
- Do not operate power tools in explosive atmospheres, such as in the presence of flammable liquids, gases or dust.** Power tools create sparks which may ignite the dust or fumes.
- Keep children and bystanders away while operating a power tool.** Distractions can cause you to lose control.

## 2. Electrical safety

- Power tool plugs must match the outlet. Never modify the plug in any way. Do not use any adapter plugs with earthed (grounded) power tools.** Unmodified plugs and matching outlets will reduce risk of electric shock.
- Avoid body contact with earthed or grounded surfaces, such as pipes, radiators, ranges and refrigerators.** There is an increased risk of electric shock if your body is earthed or grounded.
- Do not expose power tools to rain or wet conditions.** Water entering a power tool will increase the risk of electric shock.
- Do not abuse the cord. Never use the cord for carrying, pulling or unplugging the power tool. Keep cord away from heat, oil, sharp edges or moving parts.** Damaged or entangled cords increase the risk of electric shock.
- When operating a power tool outdoors, use an extension cord suitable for outdoor use.** Use of a cord suitable for outdoor use reduces the risk of electric shock.
- If operating a power tool in a damp location is unavoidable, use a residual current device (RCD) protected supply.** Use of an RCD reduces the risk of electric shock.

## 3. Personal safety

- Stay alert, watch what you are doing and use common sense when operating a power tool. Do not use a power tool while you are tired or under the influence of drugs, alcohol or medication.** A moment of inattention while operating power tools may result in serious personal injury.
- Use personal protective equipment. Always wear eye protection.** Protective equipment such as dust mask, non-skid safety shoes, hard hat, or hearing protection used for appropriate conditions will reduce personal injuries.
- Prevent unintentional starting. Ensure the switch is in the off-position before connecting to power source and/or battery pack, picking up or carrying the tool.** Carrying power tools with your finger on the switch or energising power tools that have the switch on invites accidents.
- Remove any adjusting key or wrench before turning the power tool on.** A wrench or a key left attached to a rotating part of the power tool may result in personal injury.
- Do not overreach. Keep proper footing and balance at all times.** This enables better control of the power tool in unexpected situations.

- Dress properly. Do not wear loose clothing or jewellery. Keep your hair, clothing and gloves away from moving parts.** Loose clothes, jewellery or long hair can be caught in moving parts.
- If devices are provided for the connection of dust extraction and collection facilities, ensure these are connected and properly used.** Use of dust collection can reduce dust-related hazards.

## 4. Power tool use and care

- Do not force the power tool. Use the correct power tool for your application.** The correct power tool will do the job better and safer at the rate for which it was designed.
- Do not use the power tool if the switch does not turn it on and off.** Any power tool that cannot be controlled with the switch is dangerous and must be repaired.
- Disconnect the plug from the power source and/or the battery pack from the power tool before making any adjustments, changing accessories, or storing power tools.** Such preventive safety measures reduce the risk of starting the power tool accidentally.
- Store idle power tools out of the reach of children and do not allow persons unfamiliar with the power tool or these instructions to operate the power tool.** Power tools are dangerous in the hands of untrained users.
- Maintain power tools. Check for misalignment or binding of moving parts, breakage of parts and any other condition that may affect the power tool's operation. If damaged, have the power tool repaired before use.** Many accidents are caused by poorly maintained power tools.
- Keep cutting tools sharp and clean.** Properly maintained cutting tools with sharp cutting edges are less likely to bind and are easier to control.
- Use the power tool, accessories and tool bits etc. in accordance with these instructions, taking into account the working conditions and the work to be performed.** Use of the power tool for operations different from those intended could result in a hazardous situation.

## 5. Battery tool use and care

- Recharge only with the charger specified by the manufacturer.** A charger that is suitable for one type of battery pack may create a risk of fire when used with another battery pack.
- Use power tools only with specifically designated battery packs.** Use of any other battery packs may create a risk of injury and fire.
- When battery pack is not in use, keep it away from other metal objects, like paper clips, coins, keys, nails, screws or other small metal objects, that can make a connection from one terminal to another.** Shorting the battery terminals together may cause burns or a fire.
- Under abusive conditions, liquid may be ejected from the battery; avoid contact. If contact accidentally occurs, flush with water. If liquid contacts eyes, additionally seek medical help.** Liquid ejected from the battery may cause irritation or burns.

## 6. Service

- Have your power tool serviced by a qualified repair person using only identical replacement parts.** This will ensure that the safety of the power tool is maintained.



# BLOWER SAFETY WARNINGS

- Always wear adequate protective clothing when operating the blower to avoid injuries to face, eyes, hands, feet, head or hearing. Use safety glasses or a face shield, high boots or sturdy shoes, long trousers, work gloves, a hard hat and ear defenders.
- Do not start the tool when it is upside down or when it is not in the operating position.
- Switch the motor off and remove the battery when the tool is not being used, left unattended, being cleaned or being moved from one place to another.
- Do not operate the tool near people, especially children or pets. Turn it off if they get too close. Maintain a safe distance of at least 5m from other people when using the tool.
- Never direct the blower direction nozzle towards bystanders or pets. Never blow debris in the direction of bystanders or pets. The operator is responsible for accidents or hazards occurring to other people or their property.
- Do not handle the battery or the tool with wet hands and do not use the tool in the rain.
- Keep all the air intakes and the blower tube free of dust, lint, hair and other material that may cause a reduction in air flow.
- Keep a balanced and stable stance while using the tool. Do not switch on the tool in enclosed or poorly ventilated spaces or in the presence of inflammable and/or explosive substances such as liquids, gasses and powders.
- Do not get distracted and always concentrate on what you are doing. Use common sense. Never operate the tool when you are tired, sick or under the influence of alcohol or other drugs.

- Do not operate this appliance with long loose hair or loose fitting jewellery. Tie long loose hair back and remove loose fitting jewellery.
- Only operate the tool during broad daylight or with adequate artificial light.
- When the tool is not in use, store it in a dry place and out of reach of children.
- Only use the tool according to the instructions given in this manual.
- Check regularly that the screws are tight.



**WARNING!** When servicing, use only identical replacement parts. Use of any other parts may create a hazard or cause product damage. To ensure safety and reliability, all repairs should be performed by a qualified service technician.



**WARNING!** This appliance is not intended for use by young or infirm persons unless supervised by a responsible person to ensure that they can use the appliance safely. Young children should be supervised to ensure that they do not play with the appliance.



18V LITHIUM ION

# 1.5Ah BATTERY

## INSTRUCTION MANUAL

### SPECIFICATIONS

Input: 18V  
 Battery Power: 1.5Ah Li-ion  
 Charge Times: 40min (Multi Battery Charger)  
 30min (Fast Charger)  
 60min (Standard Charger)  
 2Hr (Eco Charger)  
 Weight: 0.35kg

ozito.com.au

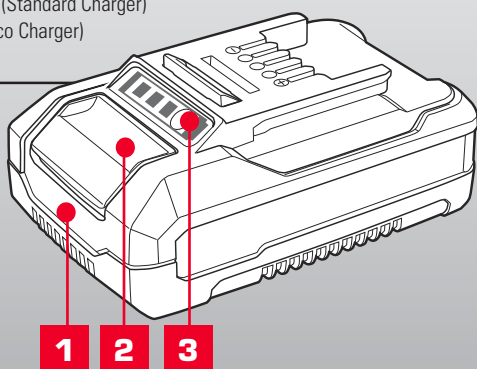

1. Battery
2. Battery Release Button
3. Charge Indicator Button

**3 YEAR**  
REPLACEMENT WARRANTY

PXBP-150

## DESCRIPTION OF SYMBOLS

<b>V</b>	Volts	<b>Hz</b>	Hertz
<b>ac/~</b>	Alternating Current	<b>W</b>	Watts
<b>dc</b>	Direct Current	<b>Ah</b>	Amp Hour
<b>mA</b>	Milliamperes		Warning
	Lithium Ion Battery		Do not use or store battery in temperatures exceeding 50°C
	Recycle Battery		Do not put in the rubbish
	Do not incinerate		Do not get battery wet

## CARING FOR THE ENVIRONMENT



Power tools that are no longer usable should not be disposed of with household waste but in an environmentally friendly way. Please recycle where facilities exist. Check with your local council authority for recycling advice.



Recycling packaging reduces the need for landfill and raw materials. Reuse of recycled material decreases pollution in the environment. Please recycle packaging where facilities exist. Check with your local council authority for recycling advice.

## BATTERY SAFETY WARNINGS

THIS MANUAL CONTAINS IMPORTANT SAFETY AND OPERATING INSTRUCTIONS FOR YOUR BATTERY CHARGER.

1. Before using the charger read all instructions and cautionary markings on the charger, battery pack and the product using the battery pack.
2. This charger is not intended for any uses other than charging rechargeable batteries. Any other use may result in risk of fire, electric shock or electrocution.
3. Do not place any object on top of the charger or place the charger on a soft surface that may result in excessive internal heat. Place the charger in a position away from any heat source.
4. To reduce risk of damage to the electric plug and cord, pull by the plug rather than the cord when disconnecting the charger.
5. Make sure the cord is located so that it will not be stepped on, tripped over, or otherwise subjected to damage or stress.
6. An extension cord should not be used unless absolutely necessary. Use of an improper extension cord could result in the risk of fire, electric shock or electrocution.
7. Do not operate the charger if it has received a sharp blow, been dropped or otherwise damaged in any way. Have it checked by an electrician or power tool repairer.
8. Do not disassemble charger. Take it to an electrician or power tool repairer when service or repair is required. Incorrect reassembly may result in a risk of electric shock, electrocution or fire.
9. To reduce risk of electric shock, unplug the charger from the outlet before attempting any cleaning. Removing the battery pack will not reduce this risk.
10. Never attempt to connect 2 chargers together.
11. DO NOT store or use the tool and battery pack in locations where the temperature may reach or exceed 40°C (such as inside sheds or metal buildings in summer).
12. The charger is designed to operate on standard household electrical power (240 volts). Do not attempt to use it on any other voltage!
13. The battery pack is not fully charged out of the carton. First read the safety instructions and then follow the charging notes and procedures.
14. The longest life and best performance can be obtained if the battery pack is charged when the air temperature is between 18 - 24°C. Do not charge the battery pack in an air temperature below 10°C or above 40°C. This is important and will prevent damage to the battery pack.
15. Do not incinerate the battery pack even if it is seriously damaged or is completely worn out. The battery can explode in a fire.
16. Never attempt to open the battery pack for any reason. If the plastic housing of the battery pack breaks or cracks, immediately discontinue use and do not recharge.
17. During charging, the battery must be placed in a well ventilated area.

## ELECTRICAL SAFETY

**WARNING!** When using mains-powered tools, basic safety precautions, including the following, should always be followed to reduce risk of fire, electric shock, personal injury and material damage.

Read the whole manual carefully and make sure you know how to switch the tool off in an emergency, before operating the tool.

Save these instructions and other documents supplied with this tool for future reference.

Note: The supply of 230V and 240V on Ozito tools are interchangeable for Australia and New Zealand.



This tool's charger is double insulated therefore no earth wire is required.

If the supply cord is damaged, it must be replaced by the manufacturer, its service agent or similarly qualified persons in order to avoid hazard.

**Note:** Double insulation does not take the place of normal safety precautions when operating this tool. The insulation system is for added protection against injury resulting from a possible electrical insulation failure within the tool.

### Using an Extension Lead

Always use an approved extension lead suitable for the power input of this tool. Before use, inspect the extension lead for signs of damage, wear and ageing. Replace the extension lead if damaged or defective.

When using an extension lead on a reel, always unwind the lead completely. Use of an extension lead not suitable for the power input of the tool or which is damaged or defective may result in a risk of fire and electric shock.

To reduce the risk of electric shock, we recommend the use of a residual current device (rated 30mA or less).

This appliance is not intended for use by persons (including children) with reduced physical, sensory or mental capabilities, or lack of experience and knowledge, unless they have been given supervision or instruction concerning use of the appliance by a person responsible for their safety.

Children should be supervised to ensure that they do not play with the appliance.

# 1. OPERATION

Only use the battery pack with Ozito Power X Change 18V cordless products.

## CHARGING YOUR LITHIUM ION BATTERY

This battery has been shipped in a low charge condition, and requires charging prior to use. Allow several cycles of charging and discharging (through use with a compatible tool) for the battery to reach its optimum performance / runtime.

This battery is compatible with chargers from the 18V Ozito Power X Change range available through your local Bunnings Warehouse: Product availability may differ.

- **PXMBC-002 Multi Battery Charger**
- **PXCG-030 Fast Charger**
- **PXCG-060 Standard Charger**
- **PXCG-120 Eco Charger**

1. Insert the power plug of the charger into the mains socket outlet. The green LED will begin to flash when properly connected to power supply.
2. Insert the battery pack into the battery charger .
3. Remove battery from the charger once fully charged. Disconnect the charger from the power supply.

**Note:** The battery pack can become a little warm during the charging. This is normal

If the battery pack fails to charge, check:

- if there is voltage at the socket outlet
- that the battery and charger are properly connected.

If the battery pack still fails to charge, please contact our customer service center.

## BATTERY CHARGE INDICATOR

The purchased battery is equipped with a battery charge indicator to show the state of the battery charge.

Press the charge indicator button and look to see which LED lights.

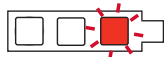
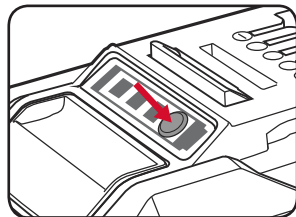

Battery requires immediate charging



Low state of charge, requires charging soon.



Mid state of charge



Full state of charge.

**Note:** The battery needs to be removed from the tool to check the state of charge.

## BATTERY PROTECTION SYSTEM

The tool is equipped with a battery protection system, which helps to ensure longevity of the battery.

The output power automatically cuts off during operation when the tool and/or battery are placed under the following situations:

- **When the tool is overloaded:**  
If this occurs, release the trigger switch and remove causes of overload, then pull the switch trigger again to restart.
- **When the remaining battery capacity becomes low:**  
Recharge the battery pack.

**Note:** The battery protection system does not in any way damage the tool.

**Note:** The indicated capacity may be lower than the actual level during use or immediately after using the tool.

# WARRANTY

IN ORDER TO MAKE A CLAIM UNDER THIS WARRANTY YOU MUST RETURN THE PRODUCT TO YOUR NEAREST BUNNINGS WAREHOUSE WITH YOUR BUNNINGS REGISTER RECEIPT. PRIOR TO RETURNING YOUR PRODUCT FOR WARRANTY PLEASE TELEPHONE OUR CUSTOMER SERVICE HELPLINE:

**Australia 1800 069 486**

**New Zealand 0508 069 486**

TO ENSURE A SPEEDY RESPONSE PLEASE HAVE THE MODEL NUMBER AND DATE OF PURCHASE AVAILABLE. A CUSTOMER SERVICE REPRESENTATIVE WILL TAKE YOUR CALL AND ANSWER ANY QUESTIONS YOU MAY HAVE RELATING TO THE WARRANTY POLICY OR PROCEDURE.

The benefits provided under this warranty are in addition to other rights and remedies which are available to you at law.

Our goods come with guarantees that cannot be excluded at law. You are entitled to a replacement or refund for a major failure and for compensation for any other reasonably foreseeable loss or damage. You are also entitled to have the goods repaired or replaced if the goods fail to be of acceptable quality and the failure does not amount to a major failure.

Generally you will be responsible for all costs associated with a claim under this warranty, however, where you have suffered any additional direct loss as a result of a defective product you may be able to claim such expenses by contacting our customer service helpline above.

## 36 MONTH REPLACEMENT WARRANTY

Your product is guaranteed for a period of **36 months from the original date of purchase** and is intended for DIY (Do It Yourself) use only. If a product is defective it will be replaced in accordance with the terms of this warranty. Warranty excludes consumable parts.

## WARNING

**The following actions will result in the warranty being void.**

- If the tool has been operated on a supply voltage other than that specified on the tool.
- If the tool shows signs of damage or defects caused by or resulting from abuse, accidents or alterations.
- Failure to perform maintenance as set out within the instruction manual.
- If the tool is disassembled or tampered with in any way.

0318

## ONLINE MANUAL

Scan this QR Code with your mobile device to take you to the online manual.



**OZITO** Australia/New Zealand (Head Office)  
1-23 Letcon Drive, Bangholme, Victoria, Australia 3175.



18V LITHIUM ION

# 3.0Ah BATTERY

## INSTRUCTION MANUAL

### SPECIFICATIONS

Input:	18V
Battery Power:	3.0Ah Li-ion
Charge Times:	60min Fast Charger 4Hr Eco Charger
Weight:	0.6kg

ozito.com.au

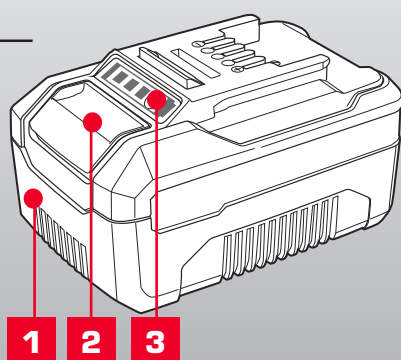

1. Battery
2. Battery Release Button
3. Charge Indicator Button

**3 YEAR**  
REPLACEMENT WARRANTY

PXBP-300

## DESCRIPTION OF SYMBOLS

<b>V</b>	Volts	<b>Hz</b>	Hertz
<b>ac/~</b>	Alternating Current	<b>W</b>	Watts
<b>dc</b>	Direct Current	<b>Ah</b>	Amp Hour
<b>mA</b>	Milliamperes		Warning
	Lithium Ion Battery		Do not use or store battery in temperatures exceeding 50°C
	Recycle Battery		Do not put in the rubbish
	Do not incinerate		Do not get battery wet

## CARING FOR THE ENVIRONMENT



Power tools that are no longer usable should not be disposed of with household waste but in an environmentally friendly way. Please recycle where facilities exist. Check with your local council authority for recycling advice.



Recycling packaging reduces the need for landfill and raw materials. Reuse of recycled material decreases pollution in the environment. Please recycle packaging where facilities exist. Check with your local council authority for recycling advice.

## BATTERY SAFETY WARNINGS

THIS MANUAL CONTAINS IMPORTANT SAFETY AND OPERATING INSTRUCTIONS FOR YOUR BATTERY CHARGER.

1. Before using the charger read all instructions and cautionary markings on the charger, battery pack and the product using the battery pack.
2. This charger is not intended for any uses other than charging rechargeable batteries. Any other use may result in risk of fire, electric shock or electrocution.
3. Do not place any object on top of the charger or place the charger on a soft surface that may result in excessive internal heat. Place the charger in a position away from any heat source.
4. To reduce risk of damage to the electric plug and cord, pull by the plug rather than the cord when disconnecting the charger.
5. Make sure the cord is located so that it will not be stepped on, tripped over, or otherwise subjected to damage or stress.
6. An extension cord should not be used unless absolutely necessary. Use of an improper extension cord could result in the risk of fire, electric shock or electrocution.
7. Do not operate the charger if it has received a sharp blow, been dropped or otherwise damaged in any way. Have it checked by an electrician or power tool repairer.
8. Do not disassemble charger. Take it to an electrician or power tool repairer when service or repair is required. Incorrect reassembly may result in a risk of electric shock, electrocution or fire.
9. To reduce risk of electric shock, unplug the charger from the outlet before attempting any cleaning. Removing the battery pack will not reduce this risk.
10. Never attempt to connect 2 chargers together.
11. DO NOT store or use the tool and battery pack in locations where the temperature may reach or exceed 40°C (such as inside sheds or metal buildings in summer).
12. The charger is designed to operate on standard household electrical power (240 volts). Do not attempt to use it on any other voltage!
13. The battery pack is not fully charged out of the carton. First read the safety instructions and then follow the charging notes and procedures.
14. The longest life and best performance can be obtained if the battery pack is charged when the air temperature is between 18 - 24°C. Do not charge the battery pack in an air temperature below 10°C or above 40°C. This is important and will prevent damage to the battery pack.
15. Do not incinerate the battery pack even if it is seriously damaged or is completely worn out. The battery can explode in a fire.
16. Never attempt to open the battery pack for any reason. If the plastic housing of the battery pack breaks or cracks, immediately discontinue use and do not recharge.
17. During charging, the battery must be placed in a well ventilated area.

## ELECTRICAL SAFETY

**WARNING!** When using mains-powered tools, basic safety precautions, including the following, should always be followed to reduce risk of fire, electric shock, personal injury and material damage.

Read the whole manual carefully and make sure you know how to switch the tool off in an emergency, before operating the tool.

Save these instructions and other documents supplied with this tool for future reference.

Note: The supply of 230V and 240V on Ozito tools are interchangeable for Australia and New Zealand.



This tool's charger is double insulated therefore no earth wire is required.

If the supply cord is damaged, it must be replaced by the manufacturer, its service agent or similarly qualified persons in order to avoid hazard.

**Note:** Double insulation does not take the place of normal safety precautions when operating this tool. The insulation system is for added protection against injury resulting from a possible electrical insulation failure within the tool.

### Using an Extension Lead

Always use an approved extension lead suitable for the power input of this tool. Before use, inspect the extension lead for signs of damage, wear and ageing. Replace the extension lead if damaged or defective.

When using an extension lead on a reel, always unwind the lead completely. Use of an extension lead not suitable for the power input of the tool or which is damaged or defective may result in a risk of fire and electric shock.

To reduce the risk of electric shock, we recommend the use of a residual current device (rated 30mA or less).

This appliance is not intended for use by persons (including children) with reduced physical, sensory or mental capabilities, or lack of experience and knowledge, unless they have been given supervision or instruction concerning use of the appliance by a person responsible for their safety.

Children should be supervised to ensure that they do not play with the appliance.

# 1. OPERATION

Only use the battery pack with Ozito Power X Change 18V cordless products.

## CHARGING YOUR LITHIUM ION BATTERY

This battery has been shipped in a low charge condition, and requires charging prior to use. Allow several cycles of charging and discharging (through use with a compatible tool) for the battery to reach its optimum performance / runtime.

This battery has two compatible Ozito chargers available through your local Bunnings Warehouse:

- **PXCG-030 Fast Charger**
- **PXCG-120 Eco Charger**

1. Insert the power plug of the charger into the mains socket outlet. The green LED will begin to flash when properly connected to power supply.
2. Insert the battery pack into the battery charger .
3. Remove battery from the charger once fully charged. Disconnect the charger from the power supply.

**Note:** The battery pack can become a little warm during the charging. This is normal

If the battery pack fails to charge, check:

- if there is voltage at the socket outlet
- that the battery and charger are properly connected.

If the battery pack still fails to charge, please contact our customer service center.

## BATTERY CHARGE INDICATOR

The purchased battery is equipped with a battery charge indicator to show the state of the battery charge.

Press the charge indicator button and look to see which LED lights.

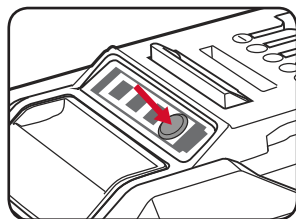

Battery requires immediate charging

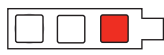

Low state of charge, requires charging soon.

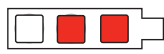

Mid state of charge

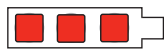

Full state of charge.

**Note:** The battery needs to be removed from the tool to check the state of charge.

## BATTERY PROTECTION SYSTEM

The tool is equipped with a battery protection system, which helps to ensure longevity of the battery.

The output power automatically cuts off during operation when the tool and/or battery are placed under the following situations:

### • When the tool is overloaded:

If this occurs, release the trigger switch and remove causes of overload, then pull the switch trigger again to restart.

### • When the remaining battery capacity becomes low:

Recharge the battery pack.

**Note:** The battery protection system does not in any way damage the tool.

**Note:** The indicated capacity may be lower than the actual level during use or immediately after using the tool.

# WARRANTY

IN ORDER TO MAKE A CLAIM UNDER THIS WARRANTY YOU MUST RETURN THE PRODUCT TO YOUR NEAREST BUNNINGS WAREHOUSE WITH YOUR BUNNINGS REGISTER RECEIPT. PRIOR TO RETURNING YOUR PRODUCT FOR WARRANTY PLEASE TELEPHONE OUR CUSTOMER SERVICE HELPLINE:

**Australia 1800 069 486**

**New Zealand 0508 069 486**

TO ENSURE A SPEEDY RESPONSE PLEASE HAVE THE MODEL NUMBER AND DATE OF PURCHASE AVAILABLE. A CUSTOMER SERVICE REPRESENTATIVE WILL TAKE YOUR CALL AND ANSWER ANY QUESTIONS YOU MAY HAVE RELATING TO THE WARRANTY POLICY OR PROCEDURE.

The benefits provided under this warranty are in addition to other rights and remedies which are available to you at law.

Our goods come with guarantees that cannot be excluded at law. You are entitled to a replacement or refund for a major failure and for compensation for any other reasonably foreseeable loss or damage. You are also entitled to have the goods repaired or replaced if the goods fail to be of acceptable quality and the failure does not amount to a major failure.

Generally you will be responsible for all costs associated with a claim under this warranty, however, where you have suffered any additional direct loss as a result of a defective product you may be able to claim such expenses by contacting our customer service helpline above.

## 36 MONTH REPLACEMENT WARRANTY

Your product is guaranteed for a period of **36 months from the original date of purchase** and is intended for DIY (Do It Yourself) use only. If a product is defective it will be replaced in accordance with the terms of this warranty. Warranty excludes consumable parts.

## WARNING

**The following actions will result in the warranty being void.**

- If the tool has been operated on a supply voltage other than that specified on the tool.
- If the tool shows signs of damage or defects caused by or resulting from abuse, accidents or alterations.
- Failure to perform maintenance as set out within the instruction manual.
- If the tool is disassembled or tampered with in any way.

## ONLINE MANUAL

Scan this QR Code with your mobile device to take you to the online manual.



**OZITO** Australia/New Zealand (Head Office)  
1-23 Letcon Drive, Bangholme, Victoria, Australia 3175.





18V LITHIUM ION

# FAST CHARGER

## INSTRUCTION MANUAL

### SPECIFICATIONS

Input:	200-250V AC 50/60Hz
Output:	21V DC, 3A
Battery Charge Time:	30Min - PXBP-150 (18V 1.5Ah)
	40Min - PXBP-200 (18V 2.0Ah)
	60Min - PXBP-300 (18V 3.0Ah)
	80Min - PXBP-400 (18V 4.0Ah)
	105Min - PXBP-520 (18V 5.2Ah)

ozito.com.au

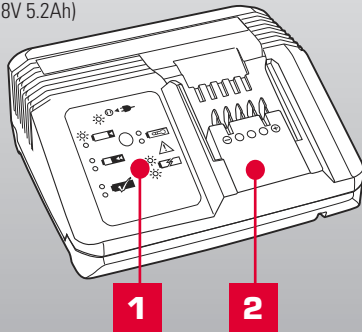

1. Charging Unit
2. Charging Unit LED

**3 YEAR**  
REPLACEMENT WARRANTY

PXCG-030

## DESCRIPTION OF SYMBOLS

<b>V</b>	Volts	<b>Hz</b>	Hertz
<b>A</b>	Amps	<b>Ah</b>	Amp Hour
	Read instruction manual		Double insulated
	Regulator compliance mark		Indoor use only
	Thermal cut out protection		Do not dispose of in rubbish

## CARING FOR THE ENVIRONMENT



Power tools that are no longer usable should not be disposed of with household waste but in an environmentally friendly way. Please recycle where facilities exist. Check with your local council authority for recycling advice.



Recycling packaging reduces the need for landfill and raw materials. Reuse of recycled material decreases pollution in the environment. Please recycle packaging where facilities exist. Check with your local council authority for recycling advice.



## CHARGER SAFETY WARNINGS

THIS MANUAL CONTAINS IMPORTANT SAFETY AND OPERATING INSTRUCTIONS FOR YOUR BATTERY CHARGER.

1. Before using the charger read all instructions and cautionary markings on the charger, battery pack and the product using the battery pack.
2. This charger is not intended for any uses other than charging rechargeable batteries. Any other use may result in risk of fire, electric shock or electrocution.
3. Do not place any object on top of the charger or place the charger on a soft surface that may result in excessive internal heat. Place the charger in a position away from any heat source.
4. To reduce risk of damage to the electric plug and cord, pull by the plug rather than the cord when disconnecting the charger.
5. Make sure the cord is located so that it will not be stepped on, tripped over, or otherwise subjected to damage or stress.
6. An extension cord should not be used unless absolutely necessary. Use of an improper extension cord could result in the risk of fire, electric shock or electrocution.
7. Do not operate the charger if it has received a sharp blow, been dropped or otherwise damaged in any way. Have it checked by an electrician or power tool repairer.
8. Do not disassemble charger. Take it to an electrician or power tool repairer when service or repair is required. Incorrect reassembly may result in a risk of electric shock, electrocution or fire.
9. To reduce risk of electric shock, unplug the charger from the outlet before attempting any cleaning. Removing the battery pack will not reduce this risk.
10. Never attempt to connect 2 chargers together.
11. DO NOT store or use the tool and battery pack in locations where the temperature may reach or exceed 40°C (such as inside sheds or metal buildings in summer).
12. The charger is designed to operate on standard household electrical power (240 volts). Do not attempt to use it on any other voltage!
13. The battery pack is not fully charged out of the carton. First read the safety instructions and then follow the charging notes and procedures.
14. The longest life and best performance can be obtained if the battery pack is charged when the air temperature is between 18 - 24°C. Do not charge the battery pack in an air temperature below 10°C or above 40°C. This is important and will prevent damage to the battery pack.
15. Do not incinerate the battery pack even if it is seriously damaged or is completely worn out. The battery can explode in a fire.
16. Never attempt to open the battery pack for any reason. If the plastic housing of the battery pack breaks or cracks, immediately discontinue use and do not recharge.
17. During charging, the battery must be placed in a well ventilated area.



## ELECTRICAL SAFETY



**WARNING!** When using mains-powered tools, basic safety precautions, including the following, should always be followed to reduce risk of fire, electric shock, personal injury and material damage.

Read the whole manual carefully and make sure you know how to switch the tool off in an emergency, before operating the tool.

Save these instructions and other documents supplied with this tool for future reference.

Note: The supply of 230V and 240V on Ozito tools are interchangeable for Australia and New Zealand.



This tools charger is double insulated therefore no earth wire is required.

If the supply cord is damaged, it must be replaced by the manufacturer, its service agent or similarly qualified persons in order to avoid hazard.

**Note:** Double insulation does not take the place of normal safety precautions when operating this tool. The insulation system is for added protection against injury resulting from a possible electrical insulation failure within the tool.

### Using an Extension Lead

Always use an approved extension lead suitable for the power input of this tool. Before use, inspect the extension lead for signs of damage, wear and ageing. Replace the extension lead if damaged or defective.

When using an extension lead on a reel, always unwind the lead completely. Use of an extension lead not suitable for the power input of the tool or which is damaged or defective may result in a risk of fire and electric shock.

To reduce the risk of electric shock, we recommend the use of a residual current device (rated 30mA or less).

This appliance is not intended for use by persons (including children) with reduced physical, sensory or mental capabilities, or lack of experience and knowledge, unless they have been given supervision or instruction concerning use of the appliance by a person responsible for their safety.

Children should be supervised to ensure that they do not play with the appliance.

## ONLINE MANUAL

Scan this QR Code with your mobile device to take you to the online manual.





## 1. CHARGING A BATTERY



**CAUTION:** THE CHARGER SHOULD BE PROTECTED BY A RESIDUAL CURRENT DEVICE (RATED AT 30MA OR LESS).

1. Place the charger on a flat surface then connect the charger into a mains power outlet.

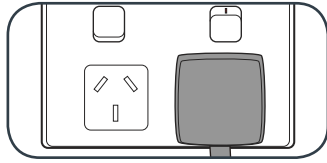

2. The charger LED will flash green showing power is being supplied to the charger.

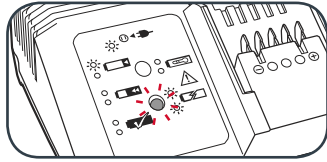

3. Align and then slide the ribs on the battery into the recess in the charger.

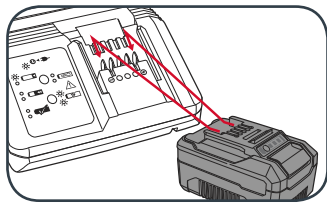

4. The red LED will illuminate while the battery charges.

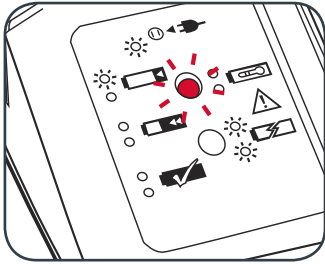

5. The green LED will illuminate once the battery is fully charged.

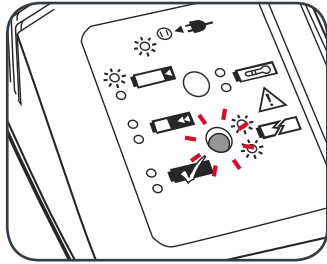

Charger LED Indicator Lights	
LED Indicator	Situation
GREEN (Flashing)	Stand By (no battery pack is inserted)
RED (Flashing)	Battery is charging (low charge)
RED (Illuminated)	Battery is fast charging (mid charge)
GREEN (Illuminated)	Battery is fully charged and is ready for use. Refer to charging times to ensure the battery is fully charged.
BOTH (Illuminated)	Battery pack is too hot or too cold (charging will begin automatically when battery reaches correct charging temperature).
BOTH (Flashing)	The battery is defective, charging is no longer possible. Do not charge. Contact Ozito Customer Service.

### Mounting the charging unit on a wall

The charging unit can be mounted to a wall or workbench. The correct dimensions for drill holes can be found on the back of the charging unit.

**Note:** When mounting on a wall you must use suitable screws, e.g.M3 pan-head screws, in order to prevent damage to the housing and risk of falling.

## 2. MAINTENANCE

- Disconnect the charger from power source before cleaning.
- Keep the charger in a dry place out of reach of children.
- If the enclosure of the charger requires cleaning, do not use solvents. Use a dry, soft cloth only to wipe down the surface. Never let any liquid get inside the charger; never immerse any part of the drill into a charger.
- There are no other parts inside the charger which require maintenance. Do not take the charger apart. If the charger is damaged, contact your supplier or the manufacturer.

## WARRANTY

IN ORDER TO MAKE A CLAIM UNDER THIS WARRANTY YOU MUST RETURN THE PRODUCT TO YOUR NEAREST BUNNINGS WAREHOUSE WITH YOUR BUNNINGS REGISTER RECEIPT. PRIOR TO RETURNING YOUR PRODUCT FOR WARRANTY PLEASE TELEPHONE OUR CUSTOMER SERVICE HELPLINE:

Australia 1800 069 486

New Zealand 0508 069 486

TO ENSURE A SPEEDY RESPONSE PLEASE HAVE THE MODEL NUMBER AND DATE OF PURCHASE AVAILABLE. A CUSTOMER SERVICE REPRESENTATIVE WILL TAKE YOUR CALL AND ANSWER ANY QUESTIONS YOU MAY HAVE RELATING TO THE WARRANTY POLICY OR PROCEDURE.

The benefits provided under this warranty are in addition to other rights and remedies which are available to you at law.

Our goods come with guarantees that cannot be excluded at law. You are entitled to a replacement or refund for a major failure and for compensation for any other reasonably foreseeable loss or damage. You are also entitled to have the goods repaired or replaced if the goods fail to be of acceptable quality and the failure does not amount to a major failure.

Generally you will be responsible for all costs associated with a claim under this warranty, however, where you have suffered any additional direct loss as a result of a defective product you may be able to claim such expenses by contacting our customer service helpline above.

### 36 MONTH REPLACEMENT WARRANTY

Your product is guaranteed for a period of **36 months from the original date of purchase** and is intended for DIY (Do It Yourself) use only. If a product is defective it will be replaced in accordance with the terms of this warranty. Warranty excludes consumable parts.

### WARNING

**The following actions will result in the warranty being void.**

- If the tool has been operated on a supply voltage other than that specified on the tool.
- If the tool shows signs of damage or defects caused by or resulting from abuse, accidents or alterations.
- Failure to perform maintenance as set out within the instruction manual.
- If the tool is disassembled or tampered with in any way.

**OZITO** Australia/New Zealand (Head Office)  
1-23 Letcon Drive, Bangholme, Victoria, Australia 3175.