

*Measure Instructions
& Order Form
included*



D.I.Y **Ezy-Fit** **ROLLERSHUTTERS**

home protection you can install yourself



Available at
BUNNINGS
warehouse



Select and Measure Instructions

Follow these steps to complete the order form at the back of this brochure.

Please contact us on 1800 633 136 if you are unsure about what to do at any step.

Customer assistance is available via phone, fax, or email.

Step 1: Area name

Choose a name or description for each roller shutter you plan to order to help you identify and install roller shutters in the right place.

Example: master bedroom, sitting room, kitchen, bedroom 1, bedroom 2, etc.

Order form sample:

* 1. Roller shutter no. 1
Area Name: ..Master bedroom.....

Step 2: Identify wall type

Brick / Precast Concrete

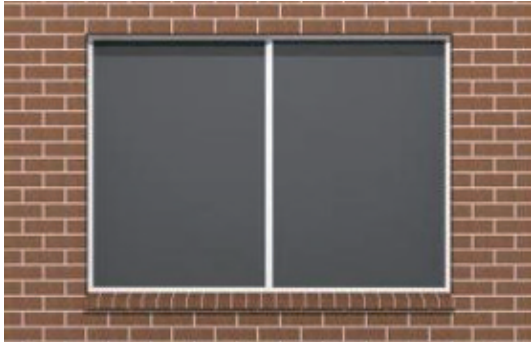

Weatherboard / Cladding



Rendered Blueboard

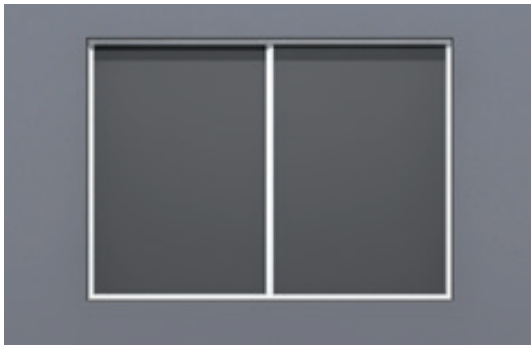

Rendered Foam



Order form sample:

- * 2. Wall type:
- Brick / Precast Concrete
 - Weatherboard / Cladding
 - Rendered Blueboard
 - Rendered Foam

Step 3: Identify window type

Double-hung



Sliding



Fixed



Awning



Casement



Hopper



Order form sample:

- * 3. Window type:
- Double-hung
 - Sliding
 - Fixed
 - Awning
 - Casement
 - Hopper

Not sure?  1800 633 136

Step 4: Select your installation type

The following are the 3 different installation types.

Face-Fit and In-Reveal options are the 2 most common, where the limited installation is only to be used if the opening is limited by an obstruction on the side.

Try and select In-Reveal installation for a more integrated look on your home, if your wall and window type permit this installation.

Face-Fit:

Suitable for all types of openings. Roller shutter guides are secured on the face of the wall and outside the opening.



Top view:

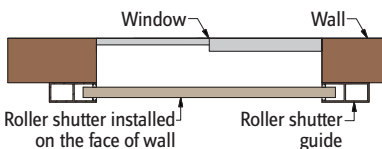

Side view:

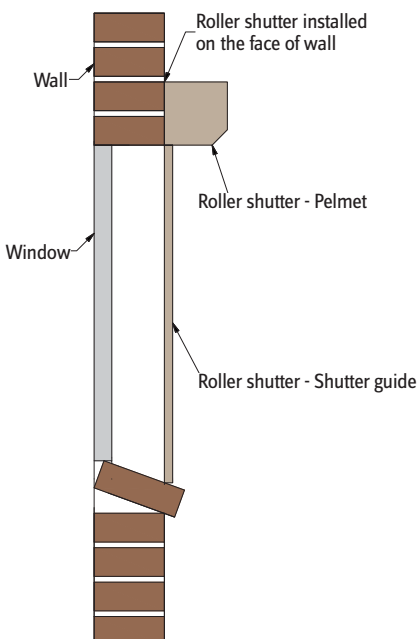

In-Reveal:

Suitable for all types of openings with a recess of at least 30 mm. Roller shutter is secured inside the opening.

Cannot be used for casement, awning, and hopper windows.



Top view:

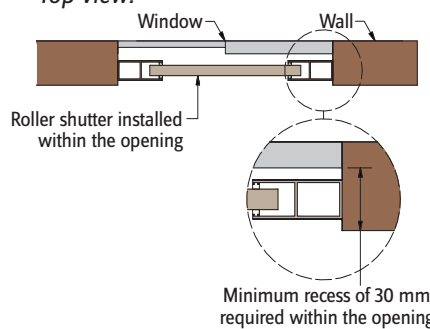

Side view:

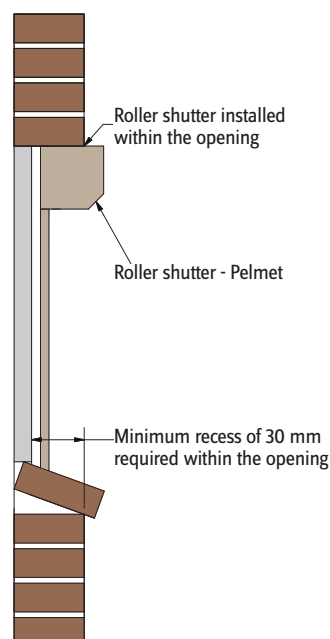

Limited:

Same as face-fit but suitable for openings that are limited by a return wall on one side.



Top view:

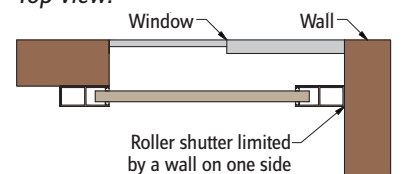

Window type	Installation type
Double-hung	All
Sliding	All
Fixed	All
Awning	Face-Fit or Limited
Casement	Face-Fit or Limited
Hopper	Face-Fit or Limited

Order form sample:

* 4. Installation:

Face-Fit In-Reveal Limited

Not sure? 1800 633 136

Step 5: Measurement

Height

Measure the **height on the face of the wall** from top to bottom of the opening and write the *exact measurement* on the order form.

Important: Do not add or subtract off the opening measurements taken.



Order form sample:

* 5. Measurements:				
Height (mm) ⇅	1	2	0	0
Width (mm) ↔				

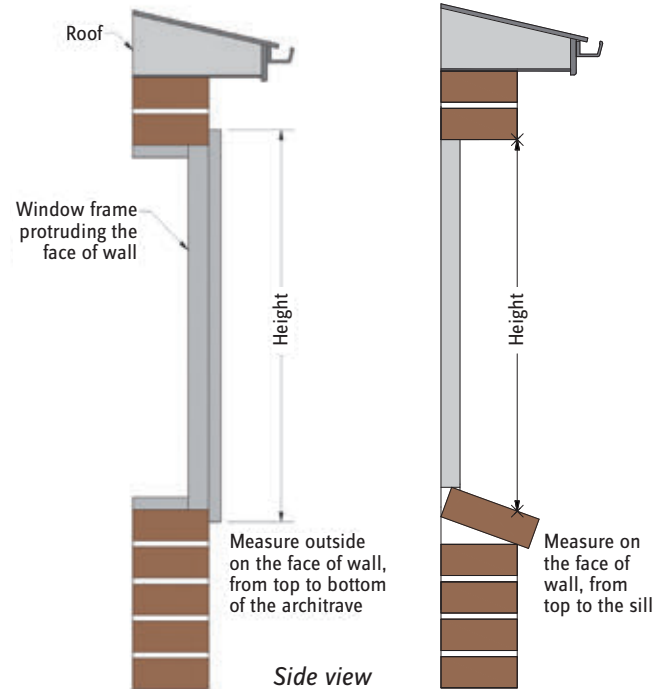

Width

Measure the **width** from left to right of the opening and write the *exact measurement* on the order form.

Important: Do not add or subtract off the opening measurements taken.

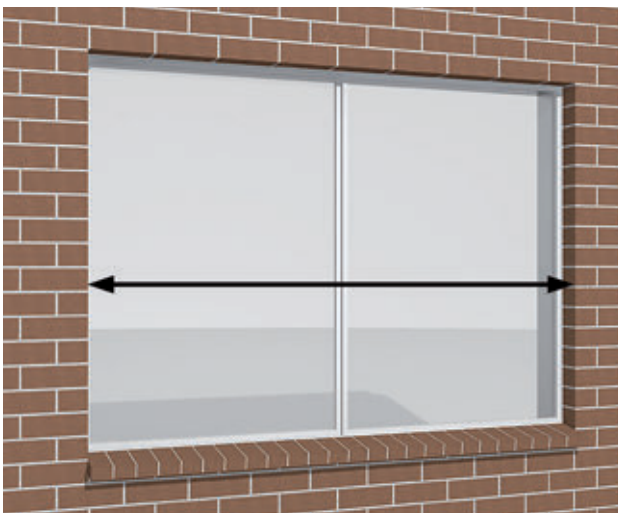

Order form sample:

* 5. Measurements:				
Height (mm) ⇅	1	2	0	0
Width (mm) ↔	1	5	0	0

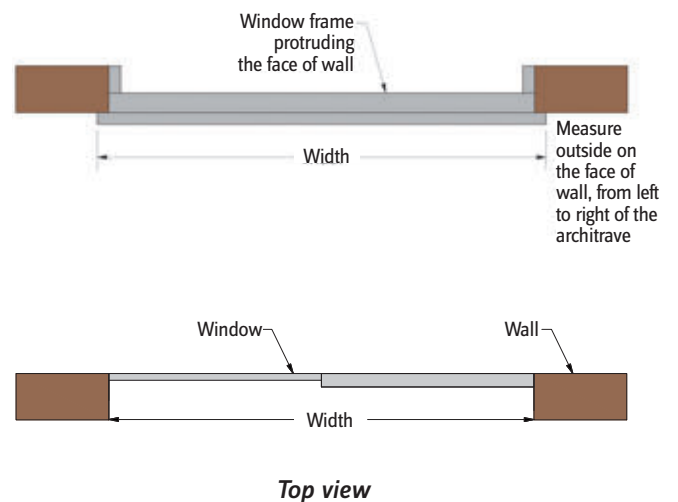

Step 6: Clearance above the opening (Face-Fit and Limited only)

If there is an obstruction (like eave, veranda, pergola, pipe, etc.) above the opening, measure the distance from the top of the opening to the obstruction. If the distance is less than 300 mm, write the measurement on the order form.

Examples:

No obstruction or clearance more than 300mm from the top of the opening

Do not fill this part of the order form.
(Keep this section blank)



Order form samples:

6. Clearance above opening:			
Distance (mm)			

If clearance is less than 300mm from top of the opening

Write the measurement on the order form.



6. Clearance above opening:			
Distance (mm)	1	5	0

If obstruction is level with the top of the opening i.e. no clearance

Write 000 on the order form.



6. Clearance above opening:			
Distance (mm)	0	0	0

Step 7: Packing profile (Face-Fit and Limited only)

Window frames or handles that protrude past the exterior wall can interfere with the operation of the shutter. *Packing profiles* are used to provide a gap between the roller shutter and the face of the exterior wall to clear the handle or window frame.

Example:

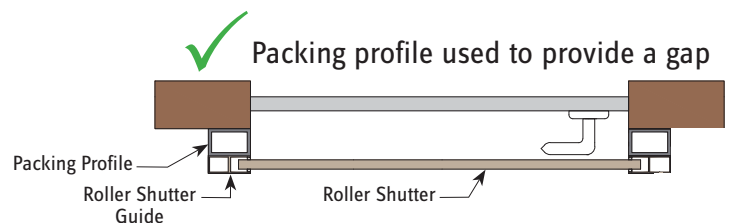
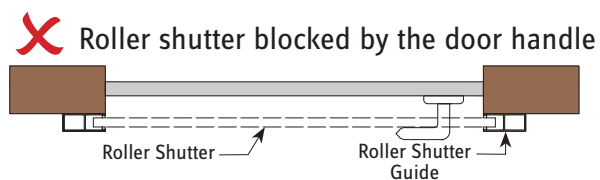

If packing profile is needed, measure from the face of the wall to the window frame or handle and write the measurement on the order form.

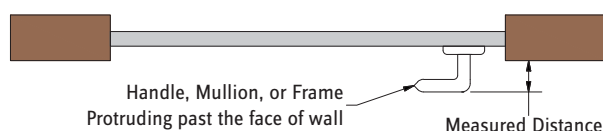

Order form sample:

7. Packing profile			
Distance (mm)	0	2	6

If not needed, leave this section blank.

Step 8: Sill

The window sill allows the roller shutter to sit and close upon it. If your windows don't have sills, you will need to use separate shutter stops.

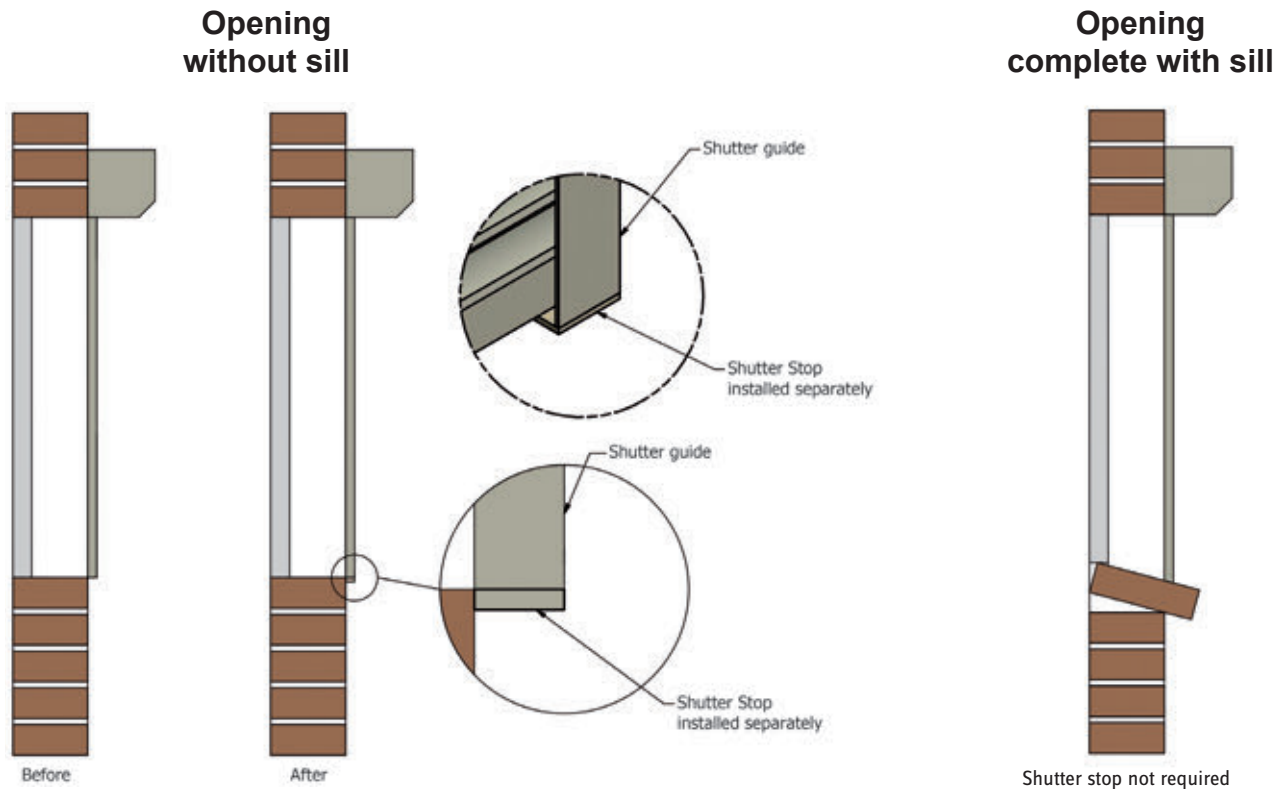

This type of wall shown requires shutter stops.

This type of wall shown does not require shutter stops.

Order form sample:

8. Sill:
<input checked="" type="checkbox"/> Shutter stop required

Order form sample:

8. Sill:
<input type="checkbox"/> Shutter stop required

* If using packing profile, ensure that your roller shutter has a closing point to sit on. If not, order shutter stops.

Step 9: Photo/Diagram assist (optional)

If you are unsure or concerned that the provided instructions do not cover your specific application (for example: corner windows, bay windows, oversize windows, etc.), you can still place your order by providing the height and width of the opening (Step 5) and completing the rest of the order form.

Take a photo or draw a diagram of the space you would like your roller shutter to be used. After placing your order at the Special Orders desk, a Bunnings Team Member will send it to us via email or fax, quoting the CSO number.

We will use the information on the order form plus the photo or diagram to manufacture your roller shutters. This is in addition to our customer support line.

Order form sample:

9. Photo/Diagram assist (optional)		
<input checked="" type="checkbox"/> E-mail	<input type="checkbox"/> Fax	<input type="checkbox"/> Post

Not sure?  1800 633 136

Step 10: Control Methods



AC Electric Motors:

- Average life span of 15 to 17 years
- Choice of wall-mounted switches or remote controls
- Connected to the AC mains of the house
- Need a qualified electrician to do the wiring for you
- With options of Remote Control and Battery Backup

Order form sample:

* 10. Control method:	
<input checked="" type="checkbox"/> AC Electric	<input type="checkbox"/> DC Battery



DC Battery Motor:

- Operates using a rechargeable handset as its power supply
- Handsets need to be recharged like a cell phone on average once a week
- Average life span of the battery is 2 to 4 years
- Average life span of the motor is 7 to 9 years
- You can connect these motors yourself without requiring an electrician
- Will still operate during a power outage

Order form sample:

* 10. Control method:	
<input type="checkbox"/> AC Electric	<input checked="" type="checkbox"/> DC Battery

Step 11: Select control side

You can select to have the control switch on the right or left of the window.
The reference on the order form for left or right is when viewed from the *inside* of the house.

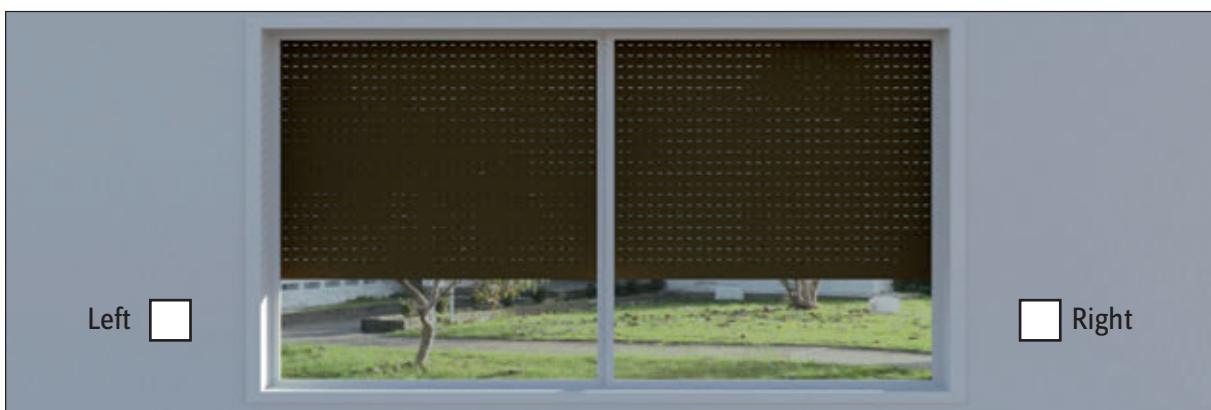

Order form sample:

* 11. Control side:	
<input checked="" type="checkbox"/> Left	<input type="checkbox"/> Right

Order form sample:

* 11. Control side:	
<input type="checkbox"/> Left	<input checked="" type="checkbox"/> Right

Not sure?  1800 633 136

Step 12: Select colours

Ezy-Fit Roller Shutters are available in 9 colours:



Use our online Colour Visualiser to match the colours with the look of your house.

Colours are subject to printing variations. To see the exact colours visit our displays at Bunnings Warehouse or use ColorBond colours catalogue.

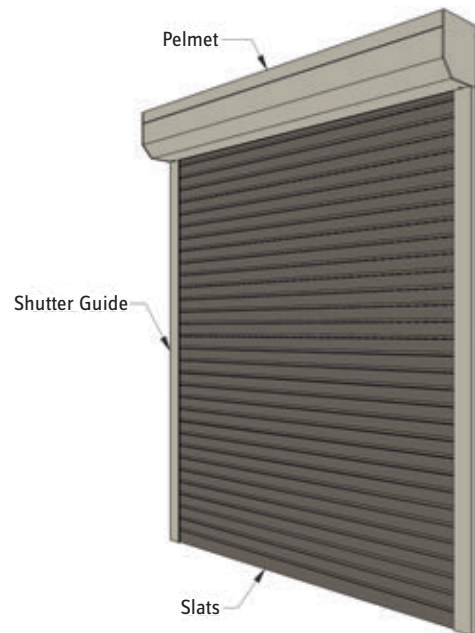

Order form sample:

* 12. Colour:
Slats:Jasper.....
Pelmet/Guides: ...Evening haze.....

Step 13: Additional extras



Remote Control for AC Electric Motors:

With the remote control, you can operate your shutters from your sofa or bed.



Battery Backup (UPS) for AC Electric Motors:

The battery backup is beneficial in instances of electrical power loss. The shutters will function for approximately eight cycles with the backup system. This is recommended for *bedroom windows* to allow the roller shutters to operate during an emergency.

A fully qualified electrician is required to wire this.

Order form sample:

13. Additional extras (AC Only)
[Available at an additional cost]
<input checked="" type="checkbox"/> Remote Control <input type="checkbox"/> Battery Backup

Order form sample:

13. Additional extras (AC Only)
[Available at an additional cost]
<input type="checkbox"/> Remote Control <input checked="" type="checkbox"/> Battery Backup

Not sure?  1800 633 136

Ezy-Fit D.I.Y Custom Made Roller Shutters Order Form



Customer Name: _____	Phone: () _____
Customer's Delivery Address: _____	Mobile: _____
Suburb: _____	State: _____ Postcode: _____

**Make sure the fields with the asterisk (*) are completed.
Select and Measure instructions must be used to complete order form correctly.**

* 1. Roller shutter no. 1				
Area Name:				
* 2. Wall type:				
<input type="checkbox"/> Brick / Precast Concrete <input type="checkbox"/> Weatherboard / Cladding <input type="checkbox"/> Rendered Blueboard <input type="checkbox"/> Rendered Foam				
* 3. Window type:				
<input type="checkbox"/> Double-hung <input type="checkbox"/> Awning <input type="checkbox"/> Sliding <input type="checkbox"/> Casement <input type="checkbox"/> Fixed <input type="checkbox"/> Hopper				
* 4. Installation:				
<input type="checkbox"/> Face-Fit <input type="checkbox"/> In-Reveal <input type="checkbox"/> Limited				
* 5. Measurements:				
Height (mm) ↓				
Width (mm) ↔				
6. Clearance above opening:				
Distance (mm)				
7. Packing profile:				
Distance (mm)				
8. Sill:				
<input type="checkbox"/> Shutter stop required				
9. Photo/Diagram assist (optional)				
<input type="checkbox"/> E-mail <input type="checkbox"/> Fax <input type="checkbox"/> Post				
* 10. Control method:				
<input type="checkbox"/> AC Electric <input type="checkbox"/> DC Battery				
* 11. Control side:				
<input type="checkbox"/> Left <input type="checkbox"/> Right				
* 12. Colour:				
Slats:				
Pelmet/Guides:				
13. Additional extras (AC Only) [Available at an additional cost]				
<input type="checkbox"/> Remote Control <input type="checkbox"/> Battery Backup				

* 1. Roller shutter no. 2				
Area Name:				
* 2. Wall type:				
<input type="checkbox"/> Brick / Precast Concrete <input type="checkbox"/> Weatherboard / Cladding <input type="checkbox"/> Rendered Blueboard <input type="checkbox"/> Rendered Foam				
* 3. Window type:				
<input type="checkbox"/> Double-hung <input type="checkbox"/> Awning <input type="checkbox"/> Sliding <input type="checkbox"/> Casement <input type="checkbox"/> Fixed <input type="checkbox"/> Hopper				
* 4. Installation:				
<input type="checkbox"/> Face-Fit <input type="checkbox"/> In-Reveal <input type="checkbox"/> Limited				
* 5. Measurements:				
Height (mm) ↓				
Width (mm) ↔				
6. Clearance above opening:				
Distance (mm)				
7. Packing profile:				
Distance (mm)				
8. Sill:				
<input type="checkbox"/> Shutter stop required				
9. Photo/Diagram assist (optional)				
<input type="checkbox"/> E-mail <input type="checkbox"/> Fax <input type="checkbox"/> Post				
* 10. Control method:				
<input type="checkbox"/> AC Electric <input type="checkbox"/> DC Battery				
* 11. Control side:				
<input type="checkbox"/> Left <input type="checkbox"/> Right				
* 12. Colour:				
Slats:				
Pelmet/Guides:				
13. Additional extras (AC Only) [Available at an additional cost]				
<input type="checkbox"/> Remote Control <input type="checkbox"/> Battery Backup				

* 1. Roller shutter no. 3				
Area Name:				
* 2. Wall type:				
<input type="checkbox"/> Brick / Precast Concrete <input type="checkbox"/> Weatherboard / Cladding <input type="checkbox"/> Rendered Blueboard <input type="checkbox"/> Rendered Foam				
* 3. Window type:				
<input type="checkbox"/> Double-hung <input type="checkbox"/> Awning <input type="checkbox"/> Sliding <input type="checkbox"/> Casement <input type="checkbox"/> Fixed <input type="checkbox"/> Hopper				
* 4. Installation:				
<input type="checkbox"/> Face-Fit <input type="checkbox"/> In-Reveal <input type="checkbox"/> Limited				
* 5. Measurements:				
Height (mm) ↓				
Width (mm) ↔				
6. Clearance above opening:				
Distance (mm)				
7. Packing profile:				
Distance (mm)				
8. Sill:				
<input type="checkbox"/> Shutter stop required				
9. Photo/Diagram assist (optional)				
<input type="checkbox"/> E-mail <input type="checkbox"/> Fax <input type="checkbox"/> Post				
* 10. Control method:				
<input type="checkbox"/> AC Electric <input type="checkbox"/> DC Battery				
* 11. Control side:				
<input type="checkbox"/> Left <input type="checkbox"/> Right				
* 12. Colour:				
Slats:				
Pelmet/Guides:				
13. Additional extras (AC Only) [Available at an additional cost]				
<input type="checkbox"/> Remote Control <input type="checkbox"/> Battery Backup				

----- Special Orders Team Member to complete the table below -----

Order Summary				
Description	Item Number	Item Price	Qty	Item Total
Total Price (including GST)				

Team Member Name:	Fax Number: (03) 9798 8473
CSO Number:	E-mail: info@ezyfitrollershutters.com.au
Store:	



ROLLER SHUTTER COLOURS



Warranty

- 15 Years - All roller shutter parts and components
- 5 Years - AC motor, and AC wall switch
- 3 Years - DC motor
- 2 Years - AC remote control and Battery backup (optional extra)
- 1 Year - DC motor handset and battery

Applications

Windows, doorways, bars, room dividers, roof windows, canteens, pergolas, verandas, cabanas, bay windows, garden windows, curved windows, atriums, patios, closets, cupboards, garages, trucks, vans and partitioning areas.



62 Pacific Drive, Keysborough, Victoria 3173 Call Centre: 1800 633 136 www.ezyfitrollershutters.com.au

¹ Direct Delivery applies for Major Cities of Australia as per Australian Bureau of Statistics Remoteness Structure. Areas that are non Major Cities in the structure, or some properties/farms may not be able to receive direct delivery.
² 15 Working Days applies for Major Cities of Australia as per Australian Bureau of Statistics Remoteness Structure. Areas that are non Major Cities in the structure, or some properties/farms may incur delays in delivery.
³ Materials and components of the product are subject to change without notice.
⁴ The colours available are for Ezy-Fit Roller Shutters, Roller Shutter Guides & Roller Shutter Pelmetts.
⁵ The colours on this brochure are subject to printing variation.
⁶ All artworks & products contained herein and in-store are correct at the time of publication and manufacture and are subject to change without notice.
Please contact us or visit our website for further clarification on any information.
Copyright © Ultimate Shutter Pty Ltd 2013 All Rights Reserved.

More Choice
From Special Orders



Order through the SPECIAL ORDERS Desk