



18V LITHIUM ION

CORDLESS BLOWER

INSTRUCTION MANUAL

SPECIFICATIONS

Voltage:	18V
No Load Speed:	12,000/min
Max. Air Speed:	210km/hr
Weight:	1.35kg

ozito.com.au

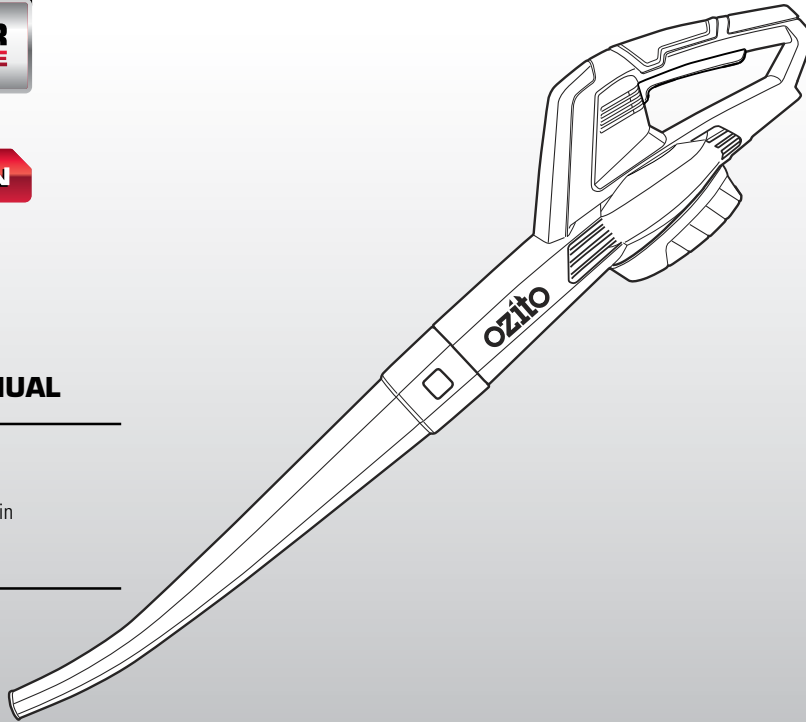

STANDARD EQUIPMENT



Cordless Blower



Blower Tube

5 YEAR
REPLACEMENT WARRANTY

PXCBLK-018

WARRANTY

IN ORDER TO MAKE A CLAIM UNDER THIS WARRANTY YOU MUST RETURN THE PRODUCT TO YOUR NEAREST BUNNINGS WAREHOUSE WITH YOUR BUNNINGS REGISTER RECEIPT. PRIOR TO RETURNING YOUR PRODUCT FOR WARRANTY PLEASE TELEPHONE OUR CUSTOMER SERVICE HELPLINE:

Australia 1800 069 486
New Zealand 0508 069 486

TO ENSURE A SPEEDY RESPONSE PLEASE HAVE THE MODEL NUMBER AND DATE OF PURCHASE AVAILABLE. A CUSTOMER SERVICE REPRESENTATIVE WILL TAKE YOUR CALL AND ANSWER ANY QUESTIONS YOU MAY HAVE RELATING TO THE WARRANTY POLICY OR PROCEDURE.

WARNING

The following actions will result in the warranty being void.

- If the tool has been operated on a supply voltage other than that specified on the tool.
- If the tool shows signs of damage or defects caused by or resulting from abuse, accidents or alterations.
- Failure to perform maintenance as set out within the instruction manual.
- If the tool is disassembled or tampered with in any way.

The benefits provided under this warranty are in addition to other rights and remedies which are available to you at law.

Our goods come with guarantees that cannot be excluded at law. You are entitled to a replacement or refund for a major failure and for compensation for any other reasonably foreseeable loss or damage. You are also entitled to have the goods repaired or replaced if the goods fail to be of acceptable quality and the failure does not amount to a major failure.

Generally you will be responsible for all costs associated with a claim under this warranty, however, where you have suffered any additional direct loss as a result of a defective product you may be able to claim such expenses by contacting our customer service helpline above.

5 YEAR REPLACEMENT WARRANTY

Your Product is guaranteed for a period of 60 months from the original date of purchase and is intended for DIY (Do It Yourself) use only. If a product is defective it will be replaced in accordance with the terms of this warranty. **Lithium Ion batteries and chargers are covered by a 36 month warranty.** Warranty excludes consumable parts, for example: blower tube.

KNOW YOUR PRODUCT

CORDLESS BLOWER

- | | |
|-------------------------|-----------------|
| 1 Blow Tube | 3 ON/OFF Switch |
| 2 Blow Tube Release Tab | 4 Handle |

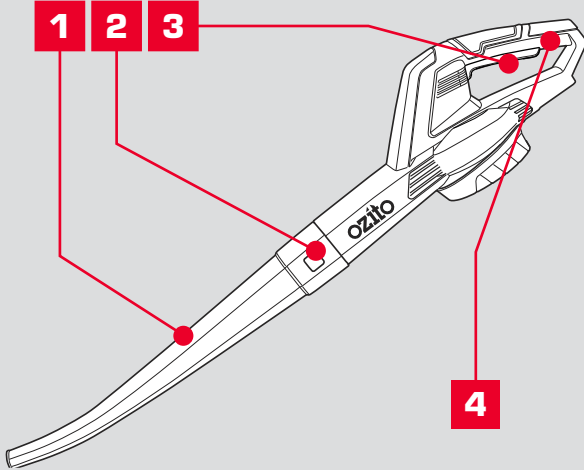

BATTERY & CHARGER

This tool is compatible with all battery and chargers from the Ozito Power X Change Range.

ONLINE MANUAL

Scan this QR Code with your mobile device to take you to the online manual.

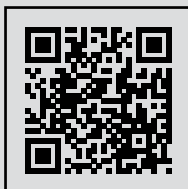

SETUP & PREPARATION

1. ASSEMBLY



WARNING! ENSURE THE TOOL IS SWITCHED OFF AND BATTERY DISCONNECTED BEFORE PERFORMING ANY OF THE FOLLOWING TASKS.

Fitting the Blower Tube

1. Align the blower tube with the outlet of the blower.

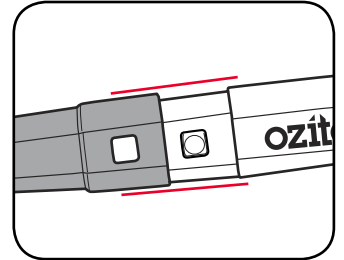

2. Push the blower tube onto the blower until it clicks into place.

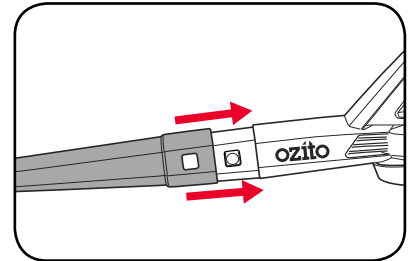

3. To remove the blower tube, press the blower tube release tab while pulling the tube away from the housing.

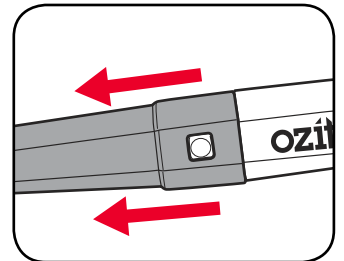

5 YEAR
REPLACEMENT WARRANTY

OPERATION

2. INSERTING & REMOVING THE BATTERY

Inserting the Battery Pack

1. Align the ribs of the battery with the recess in below the handle.

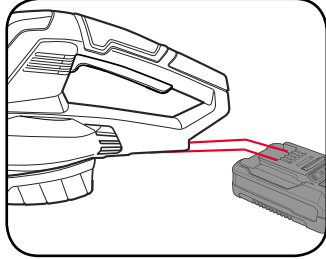

2. Slide the battery in so that it clicks into place.

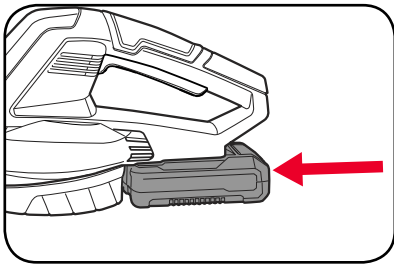

Removing a Battery from the Blower

1. Press and hold the battery release tab to release the battery.

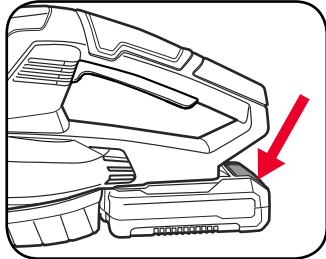

2. Slide the battery out.

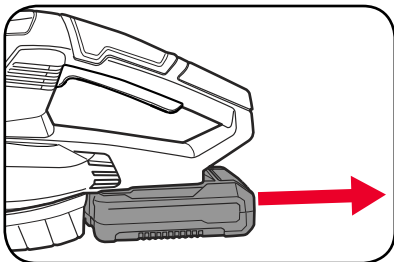

3. CONTROLS



WARNING! DO NOT USE THE BLOWER WITH ANY TYPE OF ACCESSORY OR ATTACHMENT. SUCH USAGE MIGHT BE HAZARDOUS.

Switching On and Off

1. To start the blower squeeze the on/off switch.
2. To stop the blower release the on/off switch.

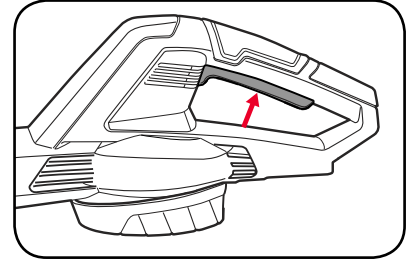

WARNING! DO NOT PUT PART OF YOUR BODY SUCH AS HANDS AND FINGERS IN THE VACUUM OPENING OR EXHAUST OPENING.



WARNING! DO NOT USE ANY ATTACHMENTS OR ACCESSORIES NOT RECOMMENDED BY THE MANUFACTURER OF THIS PRODUCT, AS IT CAN RESULT IN SERIOUS PERSONAL INJURY.

4. OPERATION



WARNING! DO NOT SWITCH THE BLOWER ON IN ENCLOSED OR POORLY VENTILATED SPACES OR IN THE PRESENCE OF FLAMMABLE AND/OR EXPLOSIVE LIQUIDS, GASES AND POWDERS.

Blowing

The blower is ideal for blowing leaves, grass clippings and other debris.

Hold the blower firmly, squeeze the on/off switch, point the jet of air in front of you and move forward slowly. Move the blower from side to side, with the tube several inches above the ground.

Be careful where you point the jet of air as it can move heavy material and cause injury or damage to bystanders.

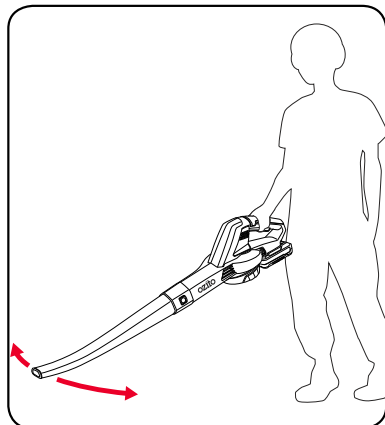

Note: Be aware of other people and animals in the area where you are to be operating the blower.

Note: Avoid collisions with hard objects which could damage your machine.

BATTERY PROTECTION SYSTEM

The tool is equipped with the battery protection system, which helps to ensure a long service life.

The output power automatically cuts off during operation when the tool and/or battery are placed under the following situations:

- **When the tool is overloaded:**

If this occurs, release the trigger switch and remove causes of overload, then pull the switch trigger again to restart.

- **When the remaining battery capacity becomes low:**

Recharge the battery pack.

Note: The battery protection system does not in any way damage the tool.

Note: The indicated capacity may be lower than the actual level during use or immediately after using the tool.

MAINTENANCE



WARNING! ALWAYS ENSURE THE TOOL HAS COMPLETELY STOPPED AND THE BATTERY IS REMOVED PRIOR TO ANY MAINTENANCE.

- Keep air intake clean and air vents free of debris to avoid overheating the motor.
- Do not use cleaning agents to clean the plastic parts of the tool. A mild detergent on a damp cloth is recommended. Water must never come into contact with the tool.
- If the blower vibrates abnormally, stop motor immediately. Abnormal vibration usually indicates a mechanical problem continued operation could lead to injury or damage.
- No lubrication is necessary as the motor is equipped with lifetime-lubricated bearings.

Note: Ozito Industries will not be responsible for any damage or injuries caused by the repair of the blower by an unauthorised person or by mishandling of the blower. This tool is designed for DIY use - use in commercial or industrial environments will void the warranty.

TROUBLESHOOTING

Problem	Cause	Remedy
Blower is not starting	Possible clogging	Clean the blower tube and blower outlet of any leaves or debris.
	Battery is low in charge	Charge battery
	Battery not inserted properly	Insert battery pack correctly
Blower is not operating at full capacity	Possible clogging	Clean the blower tube and blower outlet of any leaves or debris.
Motor stops while blowing	Battery has no power	Charge battery

SPARE PARTS

Spare parts can be ordered from the Special Orders Desk at your local Bunnings Warehouse.

For further information, or any parts not listed here, visit

www.ozito.com.au or contact Ozito Customer Service:

Australia 1800 069 486

New Zealand 0508 069 486

E-mail: enquiries@ozito.com.au



BATTERY AND CHARGER SAFETY WARNINGS

THIS MANUAL CONTAINS IMPORTANT SAFETY AND OPERATING INSTRUCTIONS FOR YOUR BATTERY CHARGER.

1. Before using the charger read all instructions and cautionary markings on the charger, battery pack and the product using the battery pack.
2. This charger is not intended for any uses other than charging rechargeable batteries. Any other use may result in risk of fire, electric shock or electrocution.
3. Do not place any object on top of the charger or place the charger on a soft surface that may result in excessive internal heat. Place the charger in a position away from any heat source.
4. To reduce risk of damage to the electric plug and cord, pull by the plug rather than the cord when disconnecting the charger.
5. Make sure the cord is located so that it will not be stepped on, tripped over, or otherwise subjected to damage or stress.
6. An extension cord should not be used unless absolutely necessary. Use of an improper extension cord could result in the risk of fire, electric shock or electrocution.
7. Do not operate the charger if it has received a sharp blow, been dropped or otherwise damaged in any way. Have it checked by an electrician or power tool repairer.
8. Do not disassemble charger. Take it to an electrician or power tool repairer when service or repair is required. Incorrect reassembly may result in a risk of electric shock, electrocution or fire.
9. To reduce risk of electric shock, unplug the charger from the outlet before attempting any cleaning. Removing the battery pack will not reduce this risk.
10. Never attempt to connect 2 chargers together.
11. DO NOT store or use the tool and battery pack in locations where the temperature may reach or exceed 40°C (such as inside sheds or metal buildings in summer).
12. The charger is designed to operate on standard household electrical power (240 volts). Do not attempt to use it on any other voltage!
13. The battery pack is not fully charged out of the carton. First read the safety instructions and then follow the charging notes and procedures.
14. The longest life and best performance can be obtained if the battery pack is charged when the air temperature is between 18 - 24°C. Do not charge the battery pack in an air temperature below 10°C or above 40°C. This is important and will prevent damage to the battery pack.
15. Do not incinerate the battery pack even if it is seriously damaged or is completely worn out. The battery can explode in a fire.
16. Never attempt to open the battery pack for any reason. If the plastic housing of the battery pack breaks or cracks, immediately discontinue use and do not recharge.
17. During charging, the battery must be placed in a well ventilated area.

DESCRIPTION OF SYMBOLS

V	Volts	Hz	Hertz
~	Alternating current	W	Watts
dc/---	Direct current	∅	Diameter
mA	Milliamperes	no	No load speed
/min	Revolutions or reciprocation per minute		Double insulated
	Read instruction manual		Warning
	Regulator compliance mark		Wear eye and ear protection.
	Do not use in the rain or leave the blower outdoors while raining.		
	Keep bystanders away. Do not operate whilst people especially children or pets are in the area.		

CARING FOR THE ENVIRONMENT



Power tools that are no longer usable should not be disposed of with household waste but in an environmentally friendly way. Please recycle where facilities exist. Check with your local council authority for recycling advice.



Recycling packaging reduces the need for landfill and raw materials. Reuse of recycled material decreases pollution in the environment. Please recycle packaging where facilities exist. Check with your local council authority for recycling advice.



ELECTRICAL SAFETY



WARNING! When using mains-powered tools, basic safety precautions, including the following, should always be followed to reduce risk of fire, electric shock, personal injury and material damage.

Read the whole manual carefully and make sure you know how to switch the tool off in an emergency, before operating the tool. Save these instructions and other documents supplied with this tool for future reference.

The charger has been designed for 230V and 240V only. Always check that the power supply corresponds to the voltage on the rating plate.

Note: The supply of 230V and 240V on Ozito tools are interchangeable for Australia and New Zealand.



This tool's charger is double insulated in therefore no earth wire is required.

If the supply cord is damaged, it must be replaced by an electrician or a power tool repairer in order to avoid a hazard.

Note: Double insulation does not take the place of normal safety precautions when operating this tool. The insulation system is for added protection against injury resulting from a possible electrical insulation failure within the tool.

The power supply for this product's charger should be protected by a residual current device (rated at 30mA or less). A residual current device reduces the risk of electric shock.



GENERAL POWER TOOL SAFETY WARNINGS



WARNING! Read all safety warnings and all instructions. Failure to follow the warnings and instructions may result in electric shock, fire and/or serious injury.

Save all warnings and instructions for future reference. The term "power tool" in the warnings refers to your mains-operated (corded) power tool or battery-operated (cordless) power tool.

1. Work area safety

- Keep work area clean and well lit.** Cluttered or dark areas invite accidents.
- Do not operate power tools in explosive atmospheres, such as in the presence of flammable liquids, gases or dust.** Power tools create sparks which may ignite the dust or fumes.
- Keep children and bystanders away while operating a power tool.** Distractions can cause you to lose control.

2. Electrical safety

- Power tool plugs must match the outlet. Never modify the plug in any way. Do not use any adapter plugs with earthed (grounded) power tools.** Unmodified plugs and matching outlets will reduce risk of electric shock.
- Avoid body contact with earthed or grounded surfaces, such as pipes, radiators, ranges and refrigerators.** There is an increased risk of electric shock if your body is earthed or grounded.
- Do not expose power tools to rain or wet conditions.** Water entering a power tool will increase the risk of electric shock.
- Do not abuse the cord. Never use the cord for carrying, pulling or unplugging the power tool. Keep cord away from heat, oil, sharp edges or moving parts.** Damaged or entangled cords increase the risk of electric shock.
- When operating a power tool outdoors, use an extension cord suitable for outdoor use.** Use of a cord suitable for outdoor use reduces the risk of electric shock.
- If operating a power tool in a damp location is unavoidable, use a residual current device (RCD) protected supply.** Use of an RCD reduces the risk of electric shock.

3. Personal safety

- Stay alert, watch what you are doing and use common sense when operating a power tool. Do not use a power tool while you are tired or under the influence of drugs, alcohol or medication.** A moment of inattention while operating power tools may result in serious personal injury.
- Use personal protective equipment. Always wear eye protection.** Protective equipment such as dust mask, non-skid safety shoes, hard hat, or hearing protection used for appropriate conditions will reduce personal injuries.
- Prevent unintentional starting. Ensure the switch is in the off-position before connecting to power source and/or battery pack, picking up or carrying the tool.** Carrying power tools with your finger on the switch or energising power tools that have the switch on invites accidents.
- Remove any adjusting key or wrench before turning the power tool on.** A wrench or a key left attached to a rotating part of the power tool may result in personal injury.
- Do not overreach. Keep proper footing and balance at all times.** This enables better control of the power tool in unexpected situations.

- Dress properly. Do not wear loose clothing or jewellery. Keep your hair, clothing and gloves away from moving parts.** Loose clothes, jewellery or long hair can be caught in moving parts.
- If devices are provided for the connection of dust extraction and collection facilities, ensure these are connected and properly used.** Use of dust collection can reduce dust-related hazards.

4. Power tool use and care

- Do not force the power tool. Use the correct power tool for your application.** The correct power tool will do the job better and safer at the rate for which it was designed.
- Do not use the power tool if the switch does not turn it on and off.** Any power tool that cannot be controlled with the switch is dangerous and must be repaired.
- Disconnect the plug from the power source and/or the battery pack from the power tool before making any adjustments, changing accessories, or storing power tools.** Such preventive safety measures reduce the risk of starting the power tool accidentally.
- Store idle power tools out of the reach of children and do not allow persons unfamiliar with the power tool or these instructions to operate the power tool.** Power tools are dangerous in the hands of untrained users.
- Maintain power tools. Check for misalignment or binding of moving parts, breakage of parts and any other condition that may affect the power tool's operation. If damaged, have the power tool repaired before use.** Many accidents are caused by poorly maintained power tools.
- Keep cutting tools sharp and clean.** Properly maintained cutting tools with sharp cutting edges are less likely to bind and are easier to control.
- Use the power tool, accessories and tool bits etc. in accordance with these instructions, taking into account the working conditions and the work to be performed.** Use of the power tool for operations different from those intended could result in a hazardous situation.

5. Battery tool use and care

- Recharge only with the charger specified by the manufacturer.** A charger that is suitable for one type of battery pack may create a risk of fire when used with another battery pack.
- Use power tools only with specifically designated battery packs.** Use of any other battery packs may create a risk of injury and fire.
- When battery pack is not in use, keep it away from other metal objects, like paper clips, coins, keys, nails, screws or other small metal objects, that can make a connection from one terminal to another.** Shorting the battery terminals together may cause burns or a fire.
- Under abusive conditions, liquid may be ejected from the battery; avoid contact. If contact accidentally occurs, flush with water. If liquid contacts eyes, additionally seek medical help.** Liquid ejected from the battery may cause irritation or burns.

6. Service

- Have your power tool serviced by a qualified repair person using only identical replacement parts.** This will ensure that the safety of the power tool is maintained.



BLOWER SAFETY WARNINGS

- Always wear adequate protective clothing when operating the blower to avoid injuries to face, eyes, hands, feet, head or hearing. Use safety glasses or a face shield, high boots or sturdy shoes, long trousers, work gloves, a hard hat and ear defenders.
- Do not start the tool when it is upside down or when it is not in the operating position.
- Switch the motor off and remove the battery when the tool is not being used, left unattended, being cleaned or being moved from one place to another.
- Do not operate the tool near people, especially children or pets. Turn it off if they get too close. Maintain a safe distance of at least 5m from other people when using the tool.
- Never direct the blower direction nozzle towards bystanders or pets. Never blow debris in the direction of bystanders or pets. The operator is responsible for accidents or hazards occurring to other people or their property.
- Do not handle the battery or the tool with wet hands and do not use the tool in the rain.
- Keep all the air intakes and the blower tube free of dust, lint, hair and other material that may cause a reduction in air flow.
- Keep a balanced and stable stance while using the tool. Do not switch on the tool in enclosed or poorly ventilated spaces or in the presence of inflammable and/or explosive substances such as liquids, gasses and powders.
- Do not get distracted and always concentrate on what you are doing. Use common sense. Never operate the tool when you are tired, sick or under the influence of alcohol or other drugs.

- Do not operate this appliance with long loose hair or loose fitting jewellery. Tie long loose hair back and remove loose fitting jewellery.
- Only operate the tool during broad daylight or with adequate artificial light.
- When the tool is not in use, store it in a dry place and out of reach of children.
- Only use the tool according to the instructions given in this manual.
- Check regularly that the screws are tight.



WARNING! When servicing, use only identical replacement parts. Use of any other parts may create a hazard or cause product damage. To ensure safety and reliability, all repairs should be performed by a qualified service technician.



WARNING! This appliance is not intended for use by young or infirm persons unless supervised by a responsible person to ensure that they can use the appliance safely. Young children should be supervised to ensure that they do not play with the appliance.



18V LITHIUM ION

CORDLESS HEDGE TRIMMER

INSTRUCTION MANUAL

SPECIFICATIONS

Voltage:	18V
Cutting Speed:	2,200 SPM
Max. Cutting Capacity:	11mm
Blade Length:	460mm
Weight:	2.10kg

ozito.com.au

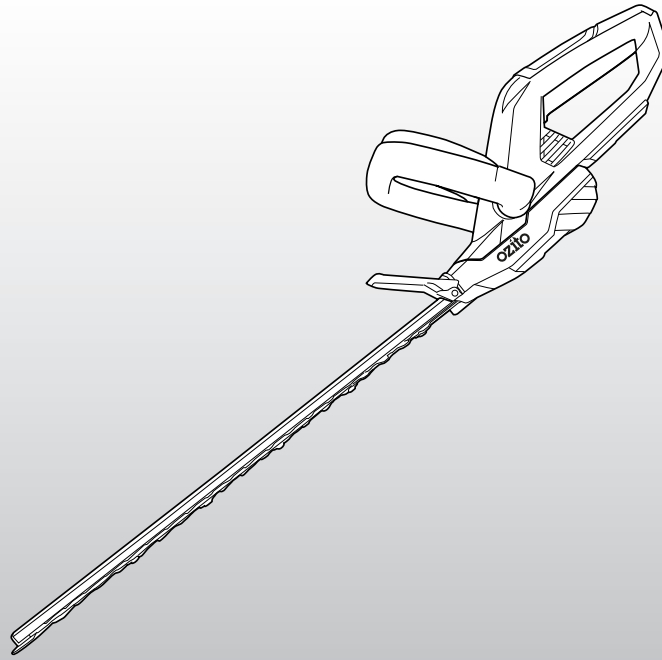

WHAT'S IN THE BOX



Cordless Hedge Trimmer

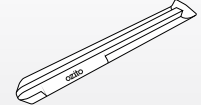

Blade Cover

5 YEAR
REPLACEMENT WARRANTY

PXCHTS-018

WARRANTY

IN ORDER TO MAKE A CLAIM UNDER THIS WARRANTY YOU MUST RETURN THE PRODUCT TO YOUR NEAREST BUNNINGS WAREHOUSE WITH YOUR BUNNINGS REGISTER RECEIPT. PRIOR TO RETURNING YOUR PRODUCT FOR WARRANTY PLEASE TELEPHONE OUR CUSTOMER SERVICE HELPLINE:

Australia 1800 069 486

New Zealand 0508 069 486

TO ENSURE A SPEEDY RESPONSE PLEASE HAVE THE MODEL NUMBER AND DATE OF PURCHASE AVAILABLE. A CUSTOMER SERVICE REPRESENTATIVE WILL TAKE YOUR CALL AND ANSWER ANY QUESTIONS YOU MAY HAVE RELATING TO THE WARRANTY POLICY OR PROCEDURE.

WARNING

The following actions will result in the warranty being void.

- If the tool has been operated on a supply voltage other than that specified on the tool.
- If the tool shows signs of damage or defects caused by or resulting from abuse, accidents or alterations.
- Failure to perform maintenance as set out within the instruction manual.
- If the tool is disassembled or tampered with in any way.

The benefits provided under this warranty are in addition to other rights and remedies which are available to you at law.

Our goods come with guarantees that cannot be excluded at law. You are entitled to a replacement or refund for a major failure and for compensation for any other reasonably foreseeable loss or damage. You are also entitled to have the goods repaired or replaced if the goods fail to be of acceptable quality and the failure does not amount to a major failure.

Generally you will be responsible for all costs associated with a claim under this warranty, however, where you have suffered any additional direct loss as a result of a defective product you may be able to claim such expenses by contacting our customer service helpline above.

5 YEAR REPLACEMENT WARRANTY

Your Product is guaranteed for a period of 60 months from the original date of purchase and is intended for DIY (Do It Yourself) use only. If a product is defective it will be replaced in accordance with the terms of this warranty. **Lithium Ion batteries and chargers are covered by a 36 month warranty.** Warranty excludes consumable parts, for example: blade, blade cover.

KNOW YOUR PRODUCT

CORDLESS HEDGE TRIMMER

- | | |
|-----------------|--------------------|
| 1. Impact Guard | 5. Safety Switch |
| 2. Blade | 6. On/Off Trigger |
| 3. Safety Guard | 7. Rear Handle |
| 4. Front Handle | 8. Battery Seating |

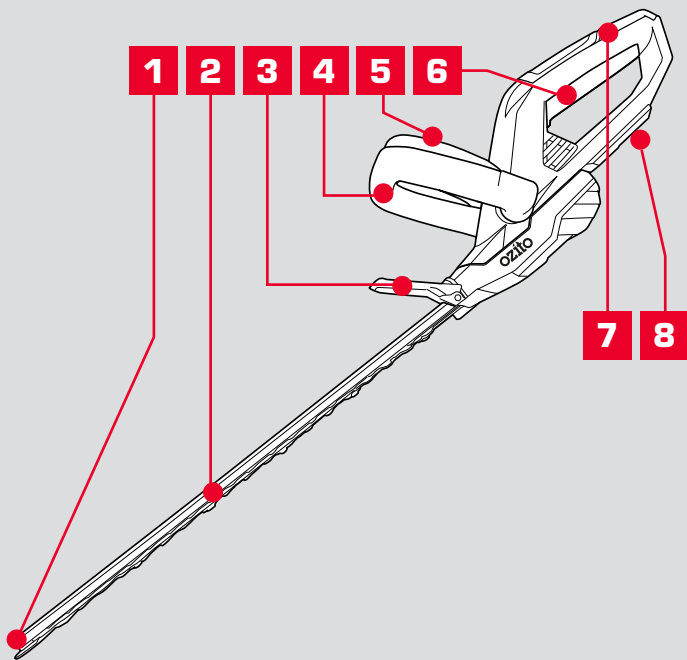

ACCESSORIES

9. Blade Cover

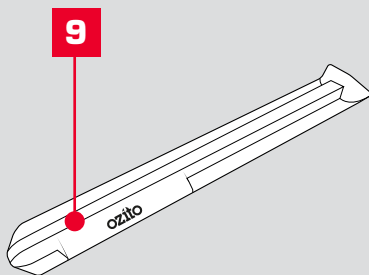

BATTERY & CHARGER

This tool is compatible with all battery and chargers from Ozito Power X Change Range.

ONLINE MANUAL

Scan this QR Code with your mobile device to take you to the online manual.

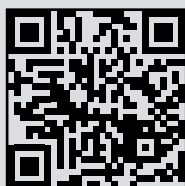

5 YEAR
REPLACEMENT WARRANTY

SETUP & PREPARATION

1. ASSEMBLY

WARNING! ENSURE THE TOOL IS SWITCHED OFF AND BATTERY DISCONNECTED BEFORE PERFORMING ANY OF THE FOLLOWING TASKS.

Blade Cover

The blade cover protects the blade when not in use. Simply slide it off the blade before use. Once finished operating, place the cover back over the blade.

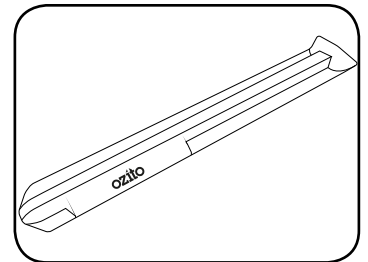

WARNING! NEVER START THE HEDGE TRIMMER WHILE THE BLADE COVER IS FITTED.

WARNING! WHEN HANDLING THE BLADE ASSEMBLY, WEAR NON-SLIP, HEAVY-DUTY PROTECTIVE GLOVES. DO NOT PLACE YOUR HAND OR FINGERS BETWEEN BLADES OR IN ANY POSITION WHERE THEY COULD GET PINCHED OR CUT. NEVER TOUCH BLADES OR SERVICE THE UNIT WITH THE BATTERY PACK INSTALLED.

Safety Guard

Ensure the safety guard is fitted securely onto the hedge trimmer before use. Tighten the screws on either side if necessary.

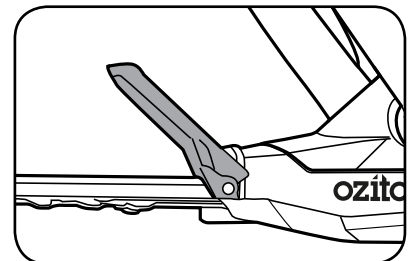

WARNING! NEVER USE THE HEDGE TRIMMING UNLESS THE SAFETY GUARD IS FITTED.

OPERATION

2. INSERTING & REMOVING THE BATTERY

Inserting the Battery into the Hedge Trimmer

1. Align the ribs of the battery with the recess in below the handle.

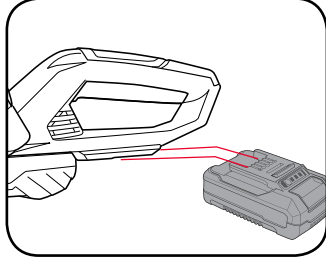

2. Slide the battery in so that it clicks into place.

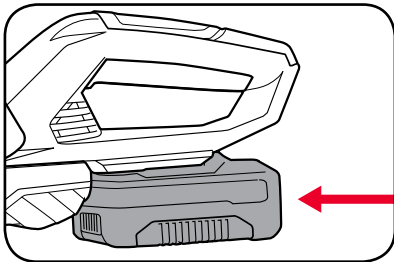

Removing the Battery from the Hedge Trimmer

1. Press and hold the battery release tab to release the battery.

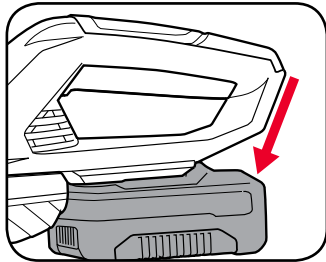

2. Slide the battery out.

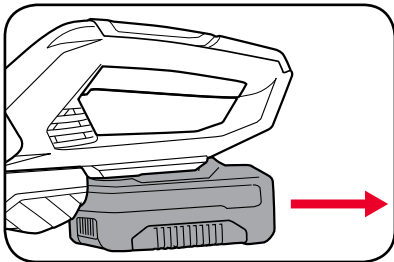

3. CONTROLS

Switching On and Off

1. Press and hold the safety switch.

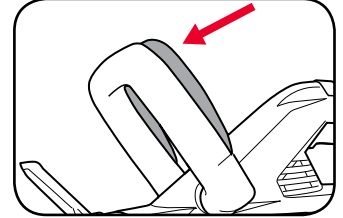

2. To start the hedge trimmer, squeeze the on/off trigger.

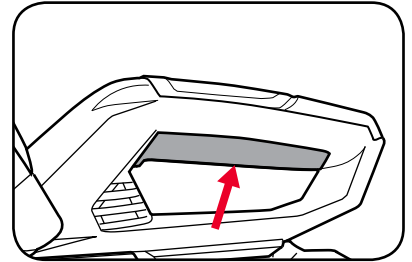

3. To stop operating, release the on/off trigger.



WARNING! DO NOT USE ANY ATTACHMENTS OR ACCESSORIES NOT RECOMMENDED BY THE MANUFACTURER OF THIS PRODUCT, AS IT CAN RESULT IN SERIOUS PERSONAL INJURY.

4. OPERATION

WARNING! CLEAR THE AREA TO BE CUT BEFORE EACH USE. REMOVE ALL OBJECTS, SUCH AS CORDS, LIGHTS, WIRE, OR STRING WHICH CAN BECOME ENTANGLED IN THE CUTTING BLADE AND CREATE A RISK OF SERIOUS PERSONAL INJURY.

Top cutting

Use a wide sweeping motion. A slight downward tilt of the cutting blades in the direction of motion gives the best cutting results.

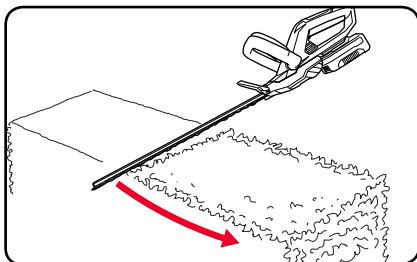

Side cutting

When trimming the sides of the hedge, begin at the bottom and cut upwards. Trim the side of a hedge so that it will be slightly narrower at the top. This shape will expose more of the hedge, resulting in a more uniform growth.

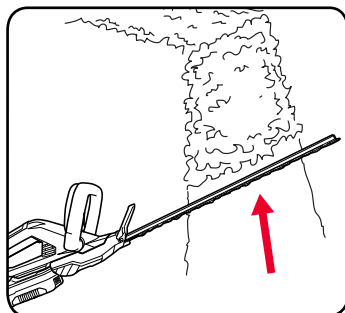

WARNING! IF THE BLADE JAMS ON ANY ELECTRICAL CORD OR LINE, DO NOT TOUCH THE BLADE! IT CAN BECOME ELECTRICALLY LIVE AND VERY DANGEROUS. CONTINUE TO HOLD THE HEDGE TRIMMER BY THE INSULATED REAR HANDLE OR LAY IT DOWN AND AWAY FROM YOU IN A SAFE MANNER. DISCONNECT THE ELECTRICAL SERVICE TO THE DAMAGED LINE OR CORD BEFORE ATTEMPTING TO FREE THE BLADE. FAILURE TO HEED THIS WARNING MAY RESULT IN SERIOUS PERSONAL INJURY OR POSSIBLE DEATH.

MAINTENANCE



WARNING! ALWAYS ENSURE THE TOOL HAS COMPLETELY STOPPED AND THE BATTERY IS REMOVED PRIOR TO ANY MAINTENANCE.

Sharpening the cutting blade

1. Start and stop your hedge trimmer until the cutter blade and the guard are slightly offset.

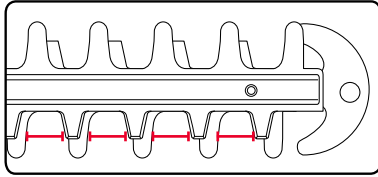

2. Remove the battery pack from your hedge trimmer.

3. Clamp the blade assembly in a vise and file the exposed cutting surface of each blade tooth. Remove as little material as possible.

4. Remove the hedge trimmer from the vise and insert the battery pack. Repeat steps 1-3 for the unsharpened edges of the blade teeth.

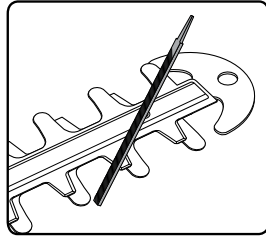

Note: Do not operate your hedge trimmer with dull or damaged cutting blades. This may cause overload and will give unsatisfactory cutting results.

Lubricating the blade

For best operation and longer blade life, lubricate the hedge trimmer blade with light weight machine oil before and after each use.

1. Remove the battery pack from the hedge trimmer.

2. Lay the hedge trimmer on a flat surface. Apply a light weight machine oil along the edge of the top blade.

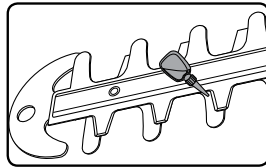

WARNING! DO NOT OIL WHILE THE HEDGE TRIMMER IS RUNNING.

Cleaning and Storage

- Keep air intake clean and air vents free of debris to avoid overheating the motor.
- Do not use cleaning agents to clean the plastic parts of the tool. A mild detergent on a damp cloth is recommended. Water must never come into contact with the tool.
- If the trimmer vibrates abnormally, stop motor immediately. Abnormal vibration usually indicates a mechanical problem continued operation could lead to injury or damage.
- Always place the blade cover on the blade before storing or transporting the hedge trimmer. Use caution to avoid the sharp teeth of the blade.
- Store the hedge trimmer indoors, in a dry place that is inaccessible to children.

Note: Ozito Industries will not be responsible for any damage or injuries caused by the repair of the trimmer by an unauthorised person or by mishandling of the trimmer. This tool is designed for DIY use - use in commercial or industrial environments will void the warranty.

TROUBLESHOOTING

Problem	Cause	Remedy
Trimmer is not starting	Possible clogging	Clean the trimmer blade of any leaves or debris.
	Battery is low in charge	Charge battery
	Battery not inserted properly	Insert battery pack correctly
Trimmer is not operating at full capacity	Possible clogging	Clean the trimmer blade of any leaves or debris.
Motor stops while trimming	Battery has no power	Charge battery

DESCRIPTION OF SYMBOLS

V	Volts	Hz	Hertz
~	Alternating current	W	Watts
dc/---	Direct current	∅	Diameter
mA	Milliamperes	No	No load speed
/min	Revolutions or reciprocation per minute		Double insulated
	Regulator compliance mark		Warning
	Read instruction manual		
	Do not use in the rain or leave the trimmer outdoors while raining.		
		Keep bystanders away. Do not operate whilst people especially children or pets are in the area.	

CARING FOR THE ENVIRONMENT



Power tools that are no longer usable should not be disposed of with household waste but in an environmentally friendly way. Please recycle where facilities exist. Check with your local council authority for recycling advice.



Recycling packaging reduces the need for landfill and raw materials. Reuse of recycled material decreases pollution in the environment. Please recycle packaging where facilities exist. Check with your local council authority for recycling advice.



ELECTRICAL SAFETY



WARNING! When using mains-powered tools, basic safety precautions, including the following, should always be followed to reduce risk of fire, electric shock, personal injury and material damage.

Read the whole manual carefully and make sure you know how to switch the tool off in an emergency, before operating the tool. Save these instructions and other documents supplied with this tool for future reference.

The charger has been designed for 230V and 240V only. Always check that the power supply corresponds to the voltage on the rating plate.

Note: The supply of 230V and 240V on Ozito tools are interchangeable for Australia and New Zealand.



This tool's charger is double insulated in accordance with AS/NZS 60745-1; therefore no earth wire is required.

If the supply cord is damaged, it must be replaced by an electrician or a power tool repairer in order to avoid a hazard.

Note: Double insulation does not take the place of normal safety precautions when operating this tool. The insulation system is for added protection against injury resulting from a possible electrical insulation failure within the tool.

Using an Extension Lead

Always use an approved extension lead suitable for the power input of this tool. Before use, inspect the extension lead for signs of damage, wear and ageing. Replace the extension lead if damaged or defective.

When using an extension lead on a reel, always unwind the lead completely. Use of an extension lead not suitable for the power input of the tool or which is damaged or defective may result in a risk of fire and electric shock.

The power supply for this product's charger should be protected by a residual current device (rated at 30mA or less). A residual current device reduces the risk of electric shock.



GENERAL POWER TOOL SAFETY WARNINGS



WARNING! Read all safety warnings and all instructions. Failure to follow the warnings and instructions may result in electric shock, fire and/or serious injury.

Save all warnings and instructions for future reference. The term "power tool" in the warnings refers to your mains-operated (corded) power tool or battery-operated (cordless) power tool.

1. Work area safety

- Keep work area clean and well lit.** Cluttered or dark areas invite accidents.
- Do not operate power tools in explosive atmospheres, such as in the presence of flammable liquids, gases or dust.** Power tools create sparks which may ignite the dust or fumes.
- Keep children and bystanders away while operating a power tool.** Distractions can cause you to lose control.

2. Electrical safety

- Power tool plugs must match the outlet. Never modify the plug in any way. Do not use any adapter plugs with earthed (grounded) power tools.** Unmodified plugs and matching outlets will reduce risk of electric shock.
- Avoid body contact with earthed or grounded surfaces, such as pipes, radiators, ranges and refrigerators.** There is an increased risk of electric shock if your body is earthed or grounded.
- Do not expose power tools to rain or wet conditions.** Water entering a power tool will increase the risk of electric shock.
- Do not abuse the cord. Never use the cord for carrying, pulling or unplugging the power tool. Keep cord away from heat, oil, sharp edges or moving parts.** Damaged or entangled cords increase the risk of electric shock.
- When operating a power tool outdoors, use an extension cord suitable for outdoor use.** Use of a cord suitable for outdoor use reduces the risk of electric shock.
- If operating a power tool in a damp location is unavoidable, use a residual current device (RCD) protected supply.** Use of an RCD reduces the risk of electric shock.

3. Personal safety

- Stay alert, watch what you are doing and use common sense when operating a power tool. Do not use a power tool while you are tired or under the influence of drugs, alcohol or medication.** A moment of inattention while operating power tools may result in serious personal injury.
- Use personal protective equipment. Always wear eye protection.** Protective equipment such as dust mask, non-skid safety shoes, hard hat, or hearing protection used for appropriate conditions will reduce personal injuries.
- Prevent unintentional starting. Ensure the switch is in the off-position before connecting to power source and/or battery pack, picking up or carrying the tool.** Carrying power tools with your finger on the switch or energising power tools that have the switch on invites accidents.
- Remove any adjusting key or wrench before turning the power tool on.** A wrench or a key left attached to a rotating part of the power tool may result in personal injury.
- Do not overreach. Keep proper footing and balance at all times.** This enables better control of the

power tool in unexpected situations.

- Dress properly. Do not wear loose clothing or jewellery. Keep your hair, clothing and gloves away from moving parts.** Loose clothes, jewellery or long hair can be caught in moving parts.
 - If devices are provided for the connection of dust extraction and collection facilities, ensure these are connected and properly used.** Use of dust collection can reduce dust-related hazards.
- ## 4. Power tool use and care
- Do not force the power tool. Use the correct power tool for your application.** The correct power tool will do the job better and safer at the rate for which it was designed.
 - Do not use the power tool if the switch does not turn it on and off.** Any power tool that cannot be controlled with the switch is dangerous and must be repaired.
 - Disconnect the plug from the power source and/or the battery pack from the power tool before making any adjustments, changing accessories, or storing power tools.** Such preventive safety measures reduce the risk of starting the power tool accidentally.
 - Store idle power tools out of the reach of children and do not allow persons unfamiliar with the power tool or these instructions to operate the power tool.** Power tools are dangerous in the hands of untrained users.
 - Maintain power tools. Check for misalignment or binding of moving parts, breakage of parts and any other condition that may affect the power tool's operation. If damaged, have the power tool repaired before use.** Many accidents are caused by poorly maintained power tools.
 - Keep cutting tools sharp and clean.** Properly maintained cutting tools with sharp cutting edges are less likely to bind and are easier to control.
 - Use the power tool, accessories and tool bits etc. in accordance with these instructions, taking into account the working conditions and the work to be performed.** Use of the power tool for operations different from those intended could result in a hazardous situation.
- ## 5. Battery tool use and care
- Recharge only with the charger specified by the manufacturer.** A charger that is suitable for one type of battery pack may create a risk of fire when used with another battery pack.
 - Use power tools only with specifically designated battery packs.** Use of any other battery packs may create a risk of injury and fire.
 - When battery pack is not in use, keep it away from other metal objects, like paper clips, coins, keys, nails, screws or other small metal objects, that can make a connection from one terminal to another.** Shorting the battery terminals together may cause burns or a fire.
 - Under abusive conditions, liquid may be ejected from the battery; avoid contact. If contact accidentally occurs, flush with water. If liquid contacts eyes, additionally seek medical help.** Liquid ejected from the battery may cause irritation or burns.
- ## 6. Service
- Have your power tool serviced by a qualified repair person using only identical replacement parts.** This will ensure that the safety of the power tool is maintained.



HEDGE TRIMMER SAFETY WARNINGS

- Keep all parts of the body away from the cutter blade.** Do not remove cut material or hold material to be cut when blades are moving. Make sure the switch is off when clearing jammed material. A moment of inattention while operating the hedge trimmer may result in serious personal injury.
- Carry the hedge trimmer by the handle with the cutter blade stopped.** When transporting or storing the hedge trimmer always fit the cutting device cover. Proper handling of the hedge trimmer will reduce possible personal injury from the cutter blades.
- Hold the power tool by insulated gripping surfaces only, because the cutter blade may contact hidden wiring.** Cutter blades contacting a "live" wire may make exposed metal parts of the power tool "live" and could give the operator an electric shock.
- Perform visual inspection on the hedge being trimmed.** To ensure no wire fences or foreign objects that the hedge trimmer may contact during operation.
 - Never allow children or people unfamiliar with these instructions to use the Hedge Trimmer.
 - Avoid using the Hedge Trimmer, while people, especially children or pets, are nearby.
 - Use the Hedge Trimmer only in daylight or good artificial light.
 - Never operate the Hedge Trimmer with damaged guards or without guards in place.
 - Switch on the Hedge Trimmer only when the hands and feet are away from the cutting blades.
 - Use only the manufacturer's recommended replacement parts and accessories.
 - Always remove the battery from the Hedge Trimmer when leaving the Hedge Trimmer unattended.
 - Always remove the battery from the Hedge Trimmer before carrying out maintenance or cleaning work.
 - Inspect and maintain the Hedge Trimmer regularly. Have the Hedge Trimmer repaired only by an authorized repairer.
 - When not in use, store the Hedge Trimmer out of the reach of children.
 - Face the cutting blades away from yourself, other people and animals while the power is connected to the Hedge Trimmer (especially during operation).
 - Use both handles.
 - Keep ventilation openings clear of debris. Keep handles dry, clean and free of oil and grease.
 - Never reach underneath the Hedge Trimmer (the cutting blade area) until it has completely stopped and the power has been disconnected.



WARNING! When servicing, use only identical replacement parts. Use of any other parts may create a hazard or cause product damage. To ensure safety and reliability, all repairs should be performed by a qualified service technician.



WARNING! This appliance is not intended for use by young or infirm persons unless supervised by a responsible person to ensure that they can use the appliance safely. Young children should be supervised to ensure that they do not play with the appliance.

SPARE PARTS

Spare parts can be ordered from the Special Orders Desk at your local Bunnings Warehouse.

For further information, or any parts not listed here, visit www.ozito.com.au or contact Ozito Customer Service:

Australia 1800 069 486

New Zealand 0508 069 486

E-mail: enquires@ozito.com.au



18V LITHIUM ION

3.0Ah BATTERY

INSTRUCTION MANUAL

SPECIFICATIONS

Input:	18V
Battery Power:	3.0Ah Li-ion
Charge Times:	60min Fast Charger 4Hr Eco Charger
Weight:	0.6kg

ozito.com.au

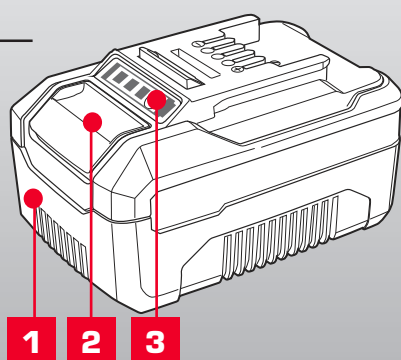

1. Battery
2. Battery Release Button
3. Charge Indicator Button

3 YEAR
REPLACEMENT WARRANTY

PXBP-300

DESCRIPTION OF SYMBOLS

V	Volts	Hz	Hertz
ac/~	Alternating Current	W	Watts
dc	Direct Current	Ah	Amp Hour
mA	Milliamperes		Warning
	Lithium Ion Battery		Do not use or store battery in temperatures exceeding 50°C
	Recycle Battery		Do not put in the rubbish
	Do not incinerate		Do not get battery wet

CARING FOR THE ENVIRONMENT



Power tools that are no longer usable should not be disposed of with household waste but in an environmentally friendly way. Please recycle where facilities exist. Check with your local council authority for recycling advice.



Recycling packaging reduces the need for landfill and raw materials. Reuse of recycled material decreases pollution in the environment. Please recycle packaging where facilities exist. Check with your local council authority for recycling advice.

BATTERY SAFETY WARNINGS

THIS MANUAL CONTAINS IMPORTANT SAFETY AND OPERATING INSTRUCTIONS FOR YOUR BATTERY CHARGER.

1. Before using the charger read all instructions and cautionary markings on the charger, battery pack and the product using the battery pack.
2. This charger is not intended for any uses other than charging rechargeable batteries. Any other use may result in risk of fire, electric shock or electrocution.
3. Do not place any object on top of the charger or place the charger on a soft surface that may result in excessive internal heat. Place the charger in a position away from any heat source.
4. To reduce risk of damage to the electric plug and cord, pull by the plug rather than the cord when disconnecting the charger.
5. Make sure the cord is located so that it will not be stepped on, tripped over, or otherwise subjected to damage or stress.
6. An extension cord should not be used unless absolutely necessary. Use of an improper extension cord could result in the risk of fire, electric shock or electrocution.
7. Do not operate the charger if it has received a sharp blow, been dropped or otherwise damaged in any way. Have it checked by an electrician or power tool repairer.
8. Do not disassemble charger. Take it to an electrician or power tool repairer when service or repair is required. Incorrect reassembly may result in a risk of electric shock, electrocution or fire.
9. To reduce risk of electric shock, unplug the charger from the outlet before attempting any cleaning. Removing the battery pack will not reduce this risk.
10. Never attempt to connect 2 chargers together.
11. DO NOT store or use the tool and battery pack in locations where the temperature may reach or exceed 40°C (such as inside sheds or metal buildings in summer).
12. The charger is designed to operate on standard household electrical power (240 volts). Do not attempt to use it on any other voltage!
13. The battery pack is not fully charged out of the carton. First read the safety instructions and then follow the charging notes and procedures.
14. The longest life and best performance can be obtained if the battery pack is charged when the air temperature is between 18 - 24°C. Do not charge the battery pack in an air temperature below 10°C or above 40°C. This is important and will prevent damage to the battery pack.
15. Do not incinerate the battery pack even if it is seriously damaged or is completely worn out. The battery can explode in a fire.
16. Never attempt to open the battery pack for any reason. If the plastic housing of the battery pack breaks or cracks, immediately discontinue use and do not recharge.
17. During charging, the battery must be placed in a well ventilated area.

ELECTRICAL SAFETY

WARNING! When using mains-powered tools, basic safety precautions, including the following, should always be followed to reduce risk of fire, electric shock, personal injury and material damage.

Read the whole manual carefully and make sure you know how to switch the tool off in an emergency, before operating the tool.

Save these instructions and other documents supplied with this tool for future reference.

Note: The supply of 230V and 240V on Ozito tools are interchangeable for Australia and New Zealand.



This tool's charger is double insulated therefore no earth wire is required.

If the supply cord is damaged, it must be replaced by the manufacturer, its service agent or similarly qualified persons in order to avoid hazard.

Note: Double insulation does not take the place of normal safety precautions when operating this tool. The insulation system is for added protection against injury resulting from a possible electrical insulation failure within the tool.

Using an Extension Lead

Always use an approved extension lead suitable for the power input of this tool. Before use, inspect the extension lead for signs of damage, wear and ageing. Replace the extension lead if damaged or defective.

When using an extension lead on a reel, always unwind the lead completely. Use of an extension lead not suitable for the power input of the tool or which is damaged or defective may result in a risk of fire and electric shock.

To reduce the risk of electric shock, we recommend the use of a residual current device (rated 30mA or less).

This appliance is not intended for use by persons (including children) with reduced physical, sensory or mental capabilities, or lack of experience and knowledge, unless they have been given supervision or instruction concerning use of the appliance by a person responsible for their safety.

Children should be supervised to ensure that they do not play with the appliance.

1. OPERATION

Only use the battery pack with Ozito Power X Change 18V cordless products.

CHARGING YOUR LITHIUM ION BATTERY

This battery has been shipped in a low charge condition, and requires charging prior to use. Allow several cycles of charging and discharging (through use with a compatible tool) for the battery to reach its optimum performance / runtime.

This battery has two compatible Ozito chargers available through your local Bunnings Warehouse:

- **PXCG-030 Fast Charger**
- **PXCG-120 Eco Charger**

1. Insert the power plug of the charger into the mains socket outlet. The green LED will begin to flash when properly connected to power supply.
2. Insert the battery pack into the battery charger .
3. Remove battery from the charger once fully charged. Disconnect the charger from the power supply.

Note: The battery pack can become a little warm during the charging. This is normal

If the battery pack fails to charge, check:

- if there is voltage at the socket outlet
- that the battery and charger are properly connected.

If the battery pack still fails to charge, please contact our customer service center.

BATTERY CHARGE INDICATOR

The purchased battery is equipped with a battery charge indicator to show the state of the battery charge.

Press the charge indicator button and look to see which LED lights.

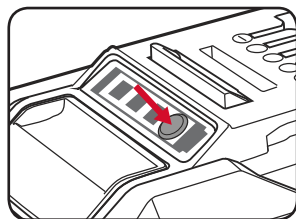

Battery requires immediate charging

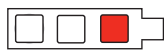

Low state of charge, requires charging soon.

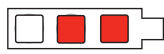

Mid state of charge

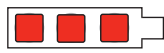

Full state of charge.

Note: The battery needs to be removed from the tool to check the state of charge.

BATTERY PROTECTION SYSTEM

The tool is equipped with a battery protection system, which helps to ensure longevity of the battery.

The output power automatically cuts off during operation when the tool and/or battery are placed under the following situations:

• When the tool is overloaded:

If this occurs, release the trigger switch and remove causes of overload, then pull the switch trigger again to restart.

• When the remaining battery capacity becomes low:

Recharge the battery pack.

Note: The battery protection system does not in any way damage the tool.

Note: The indicated capacity may be lower than the actual level during use or immediately after using the tool.

WARRANTY

IN ORDER TO MAKE A CLAIM UNDER THIS WARRANTY YOU MUST RETURN THE PRODUCT TO YOUR NEAREST BUNNINGS WAREHOUSE WITH YOUR BUNNINGS REGISTER RECEIPT. PRIOR TO RETURNING YOUR PRODUCT FOR WARRANTY PLEASE TELEPHONE OUR CUSTOMER SERVICE HELPLINE:

Australia 1800 069 486

New Zealand 0508 069 486

TO ENSURE A SPEEDY RESPONSE PLEASE HAVE THE MODEL NUMBER AND DATE OF PURCHASE AVAILABLE. A CUSTOMER SERVICE REPRESENTATIVE WILL TAKE YOUR CALL AND ANSWER ANY QUESTIONS YOU MAY HAVE RELATING TO THE WARRANTY POLICY OR PROCEDURE.

The benefits provided under this warranty are in addition to other rights and remedies which are available to you at law.

Our goods come with guarantees that cannot be excluded at law. You are entitled to a replacement or refund for a major failure and for compensation for any other reasonably foreseeable loss or damage. You are also entitled to have the goods repaired or replaced if the goods fail to be of acceptable quality and the failure does not amount to a major failure.

Generally you will be responsible for all costs associated with a claim under this warranty, however, where you have suffered any additional direct loss as a result of a defective product you may be able to claim such expenses by contacting our customer service helpline above.

36 MONTH REPLACEMENT WARRANTY

Your product is guaranteed for a period of **36 months from the original date of purchase** and is intended for DIY (Do It Yourself) use only. If a product is defective it will be replaced in accordance with the terms of this warranty. Warranty excludes consumable parts.

WARNING

The following actions will result in the warranty being void.

- If the tool has been operated on a supply voltage other than that specified on the tool.
- If the tool shows signs of damage or defects caused by or resulting from abuse, accidents or alterations.
- Failure to perform maintenance as set out within the instruction manual.
- If the tool is disassembled or tampered with in any way.

ONLINE MANUAL

Scan this QR Code with your mobile device to take you to the online manual.



OZITO Australia/New Zealand (Head Office)
1-23 Letcon Drive, Bangholme, Victoria, Australia 3175.



18V LITHIUM ION

FAST CHARGER

INSTRUCTION MANUAL

SPECIFICATIONS

Input:	200-250V AC 50/60Hz
Output:	21V DC, 3A
Battery Charge Time:	30Min - PXBP-150 (18V 1.5Ah)
	40Min - PXBP-200 (18V 2.0Ah)
	60Min - PXBP-300 (18V 3.0Ah)
	80Min - PXBP-400 (18V 4.0Ah)
	105Min - PXBP-520 (18V 5.2Ah)

ozito.com.au

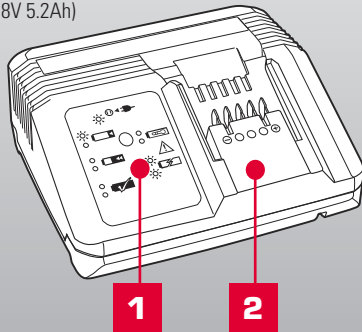

1. Charging Unit
2. Charging Unit LED

3 YEAR
REPLACEMENT WARRANTY

PXCG-030

DESCRIPTION OF SYMBOLS

V	Volts	Hz	Hertz
A	Amps	Ah	Amp Hour
	Read instruction manual		Double insulated
	Regulator compliance mark		Indoor use only
	Thermal cut out protection		Do not dispose of in rubbish

CARING FOR THE ENVIRONMENT



Power tools that are no longer usable should not be disposed of with household waste but in an environmentally friendly way. Please recycle where facilities exist. Check with your local council authority for recycling advice.



Recycling packaging reduces the need for landfill and raw materials. Reuse of recycled material decreases pollution in the environment. Please recycle packaging where facilities exist. Check with your local council authority for recycling advice.



CHARGER SAFETY WARNINGS

THIS MANUAL CONTAINS IMPORTANT SAFETY AND OPERATING INSTRUCTIONS FOR YOUR BATTERY CHARGER.

1. Before using the charger read all instructions and cautionary markings on the charger, battery pack and the product using the battery pack.
2. This charger is not intended for any uses other than charging rechargeable batteries. Any other use may result in risk of fire, electric shock or electrocution.
3. Do not place any object on top of the charger or place the charger on a soft surface that may result in excessive internal heat. Place the charger in a position away from any heat source.
4. To reduce risk of damage to the electric plug and cord, pull by the plug rather than the cord when disconnecting the charger.
5. Make sure the cord is located so that it will not be stepped on, tripped over, or otherwise subjected to damage or stress.
6. An extension cord should not be used unless absolutely necessary. Use of an improper extension cord could result in the risk of fire, electric shock or electrocution.
7. Do not operate the charger if it has received a sharp blow, been dropped or otherwise damaged in any way. Have it checked by an electrician or power tool repairer.
8. Do not disassemble charger. Take it to an electrician or power tool repairer when service or repair is required. Incorrect reassembly may result in a risk of electric shock, electrocution or fire.
9. To reduce risk of electric shock, unplug the charger from the outlet before attempting any cleaning. Removing the battery pack will not reduce this risk.
10. Never attempt to connect 2 chargers together.
11. DO NOT store or use the tool and battery pack in locations where the temperature may reach or exceed 40°C (such as inside sheds or metal buildings in summer).
12. The charger is designed to operate on standard household electrical power (240 volts). Do not attempt to use it on any other voltage!
13. The battery pack is not fully charged out of the carton. First read the safety instructions and then follow the charging notes and procedures.
14. The longest life and best performance can be obtained if the battery pack is charged when the air temperature is between 18 - 24°C. Do not charge the battery pack in an air temperature below 10°C or above 40°C. This is important and will prevent damage to the battery pack.
15. Do not incinerate the battery pack even if it is seriously damaged or is completely worn out. The battery can explode in a fire.
16. Never attempt to open the battery pack for any reason. If the plastic housing of the battery pack breaks or cracks, immediately discontinue use and do not recharge.
17. During charging, the battery must be placed in a well ventilated area.



ELECTRICAL SAFETY



WARNING! When using mains-powered tools, basic safety precautions, including the following, should always be followed to reduce risk of fire, electric shock, personal injury and material damage.

Read the whole manual carefully and make sure you know how to switch the tool off in an emergency, before operating the tool.

Save these instructions and other documents supplied with this tool for future reference.

Note: The supply of 230V and 240V on Ozito tools are interchangeable for Australia and New Zealand.



This tools charger is double insulated therefore no earth wire is required.

If the supply cord is damaged, it must be replaced by the manufacturer, its service agent or similarly qualified persons in order to avoid hazard.

Note: Double insulation does not take the place of normal safety precautions when operating this tool. The insulation system is for added protection against injury resulting from a possible electrical insulation failure within the tool.

Using an Extension Lead

Always use an approved extension lead suitable for the power input of this tool. Before use, inspect the extension lead for signs of damage, wear and ageing. Replace the extension lead if damaged or defective.

When using an extension lead on a reel, always unwind the lead completely. Use of an extension lead not suitable for the power input of the tool or which is damaged or defective may result in a risk of fire and electric shock.

To reduce the risk of electric shock, we recommend the use of a residual current device (rated 30mA or less).

This appliance is not intended for use by persons (including children) with reduced physical, sensory or mental capabilities, or lack of experience and knowledge, unless they have been given supervision or instruction concerning use of the appliance by a person responsible for their safety.

Children should be supervised to ensure that they do not play with the appliance.

ONLINE MANUAL

Scan this QR Code with your mobile device to take you to the online manual.



1. CHARGING A BATTERY



CAUTION: THE CHARGER SHOULD BE PROTECTED BY A RESIDUAL CURRENT DEVICE (RATED AT 30MA OR LESS).

1. Place the charger on a flat surface then connect the charger into a mains power outlet.

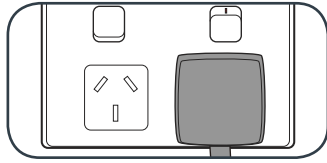

2. The charger LED will flash green showing power is being supplied to the charger.

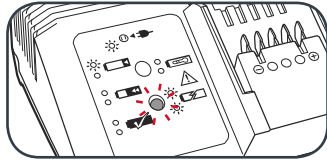

3. Align and then slide the ribs on the battery into the recess in the charger.

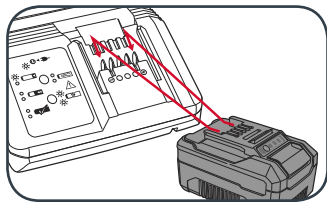

4. The red LED will illuminate while the battery charges.

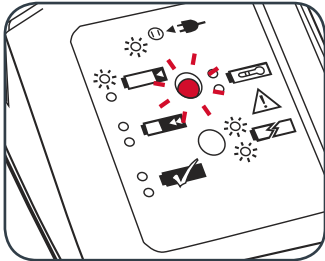

5. The green LED will illuminate once the battery is fully charged.

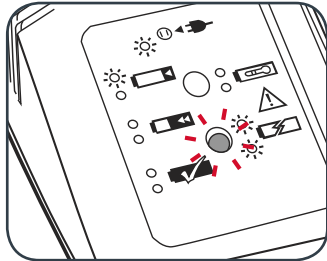

Charger LED Indicator Lights	
LED Indicator	Situation
GREEN (Flashing)	Stand By (no battery pack is inserted)
RED (Flashing)	Battery is charging (low charge)
RED (Illuminated)	Battery is fast charging (mid charge)
GREEN (Illuminated)	Battery is fully charged and is ready for use. Refer to charging times to ensure the battery is fully charged.
BOTH (Illuminated)	Battery pack is too hot or too cold (charging will begin automatically when battery reaches correct charging temperature).
BOTH (Flashing)	The battery is defective, charging is no longer possible. Do not charge. Contact Ozito Customer Service.

Mounting the charging unit on a wall

The charging unit can be mounted to a wall or workbench. The correct dimensions for drill holes can be found on the back of the charging unit.

Note: When mounting on a wall you must use suitable screws, e.g.M3 pan-head screws, in order to prevent damage to the housing and risk of falling.

2. MAINTENANCE

- Disconnect the charger from power source before cleaning.
- Keep the charger in a dry place out of reach of children.
- If the enclosure of the charger requires cleaning, do not use solvents. Use a dry, soft cloth only to wipe down the surface. Never let any liquid get inside the charger; never immerse any part of the drill into a charger.
- There are no other parts inside the charger which require maintenance. Do not take the charger apart. If the charger is damaged, contact your supplier or the manufacturer.

WARRANTY

IN ORDER TO MAKE A CLAIM UNDER THIS WARRANTY YOU MUST RETURN THE PRODUCT TO YOUR NEAREST BUNNINGS WAREHOUSE WITH YOUR BUNNINGS REGISTER RECEIPT. PRIOR TO RETURNING YOUR PRODUCT FOR WARRANTY PLEASE TELEPHONE OUR CUSTOMER SERVICE HELPLINE:

Australia 1800 069 486

New Zealand 0508 069 486

TO ENSURE A SPEEDY RESPONSE PLEASE HAVE THE MODEL NUMBER AND DATE OF PURCHASE AVAILABLE. A CUSTOMER SERVICE REPRESENTATIVE WILL TAKE YOUR CALL AND ANSWER ANY QUESTIONS YOU MAY HAVE RELATING TO THE WARRANTY POLICY OR PROCEDURE.

The benefits provided under this warranty are in addition to other rights and remedies which are available to you at law.

Our goods come with guarantees that cannot be excluded at law. You are entitled to a replacement or refund for a major failure and for compensation for any other reasonably foreseeable loss or damage. You are also entitled to have the goods repaired or replaced if the goods fail to be of acceptable quality and the failure does not amount to a major failure.

Generally you will be responsible for all costs associated with a claim under this warranty, however, where you have suffered any additional direct loss as a result of a defective product you may be able to claim such expenses by contacting our customer service helpline above.

36 MONTH REPLACEMENT WARRANTY

Your product is guaranteed for a period of **36 months from the original date of purchase** and is intended for DIY (Do It Yourself) use only. If a product is defective it will be replaced in accordance with the terms of this warranty. Warranty excludes consumable parts.

WARNING

The following actions will result in the warranty being void.

- If the tool has been operated on a supply voltage other than that specified on the tool.
- If the tool shows signs of damage or defects caused by or resulting from abuse, accidents or alterations.
- Failure to perform maintenance as set out within the instruction manual.
- If the tool is disassembled or tampered with in any way.

OZITO Australia/New Zealand (Head Office)
1-23 Letcon Drive, Bangholme, Victoria, Australia 3175.