

VELUX®

DKD/RFD

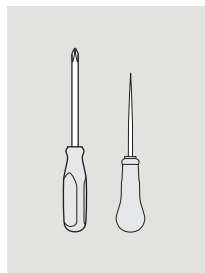

VAS 452178 - 2010-02

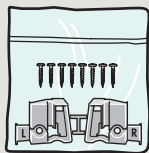
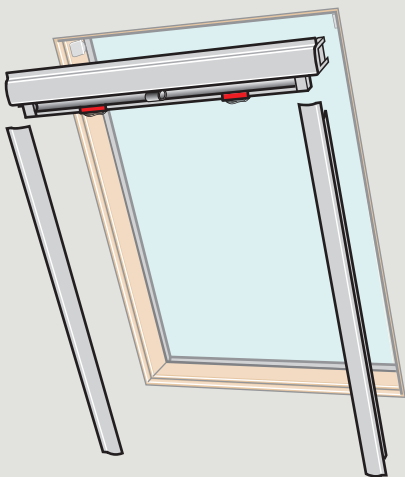

1

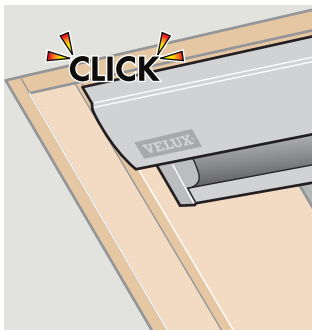
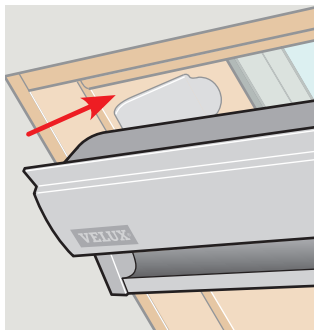
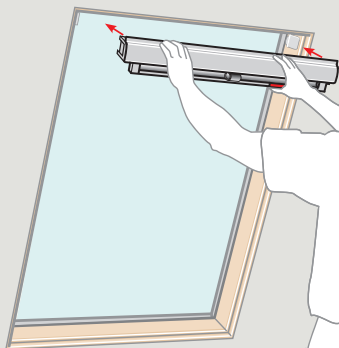

2

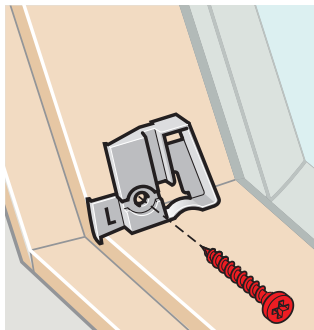
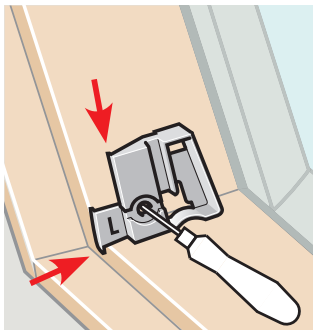
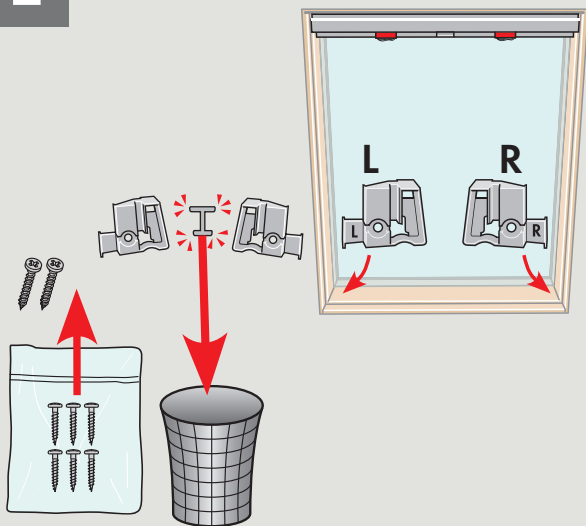

3

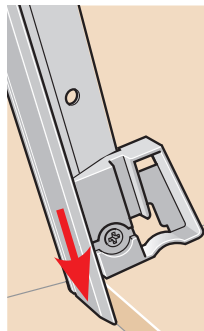
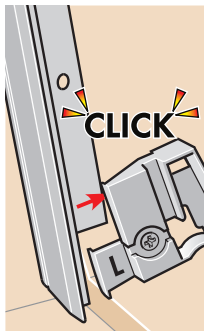
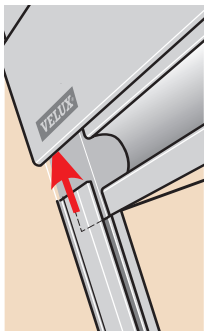
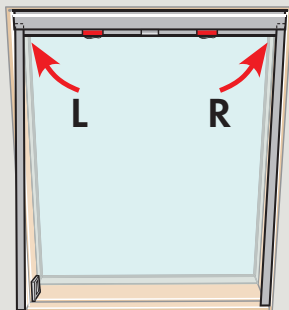
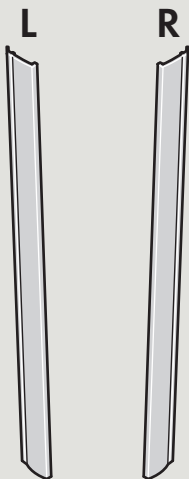

The logo consists of the word "VELUX" in a bold, white, sans-serif font, with a registered trademark symbol (®) to the upper right of the "X". The text is centered within a solid red rectangular background.

- USA:** VELUX America Inc.
1-800-88-VELUX
- CDN:** VELUX Canada Inc.
1 800 88-VELUX (888-3589)
- AUS:** VELUX Australia Pty. Ltd
1300 859 856
- NZ:** VELUX New Zealand Ltd.
09-6344 126
- J:** VELUX-Japan Ltd.
03(3478)81 41

www.velux.com

4

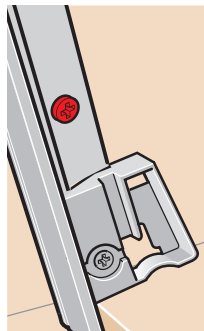
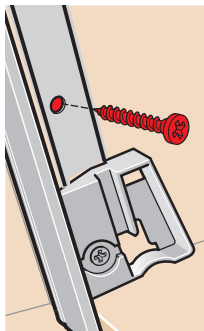
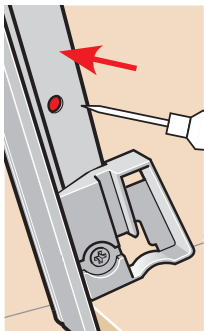
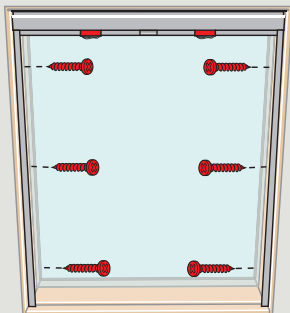
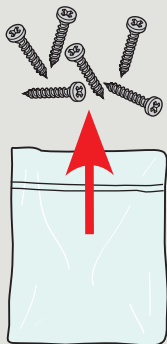

5

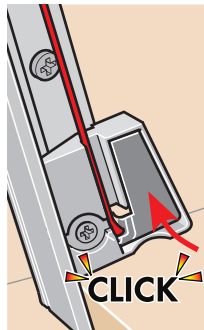
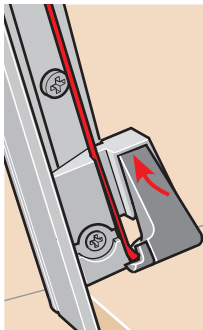
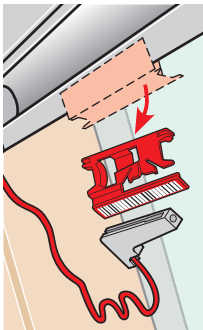
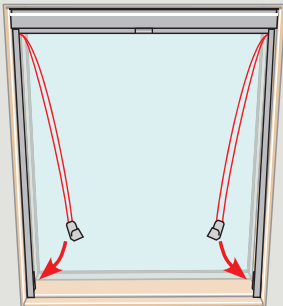
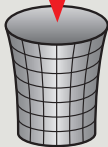



ZXT 200

