

ozito

DOUBLE BEVEL SLIDE COMPOUND MITRE SAW

210mm (8¼")

INSTRUCTION MANUAL

SPECIFICATIONS

Motor:	1800W (S2 5min), 1500W (S1)
No Load Speed:	5,000/min
Blade:	Ø210mm x Ø16 x 48T
Mitre Angle:	0-45° left & right
Bevel Angle:	0-45° left & right
Max. Cutting Capacity:	
Mitre 0° x Bevel 90°:	62 x 310mm
Mitre 45° x Bevel 90°:	62 x 210mm
Mitre 0° x Bevel 45°:	36 x 310mm
Mitre 45° x Bevel 45°:	Left 36 x 210mm Right 20 x 210mm

ozito.com.au

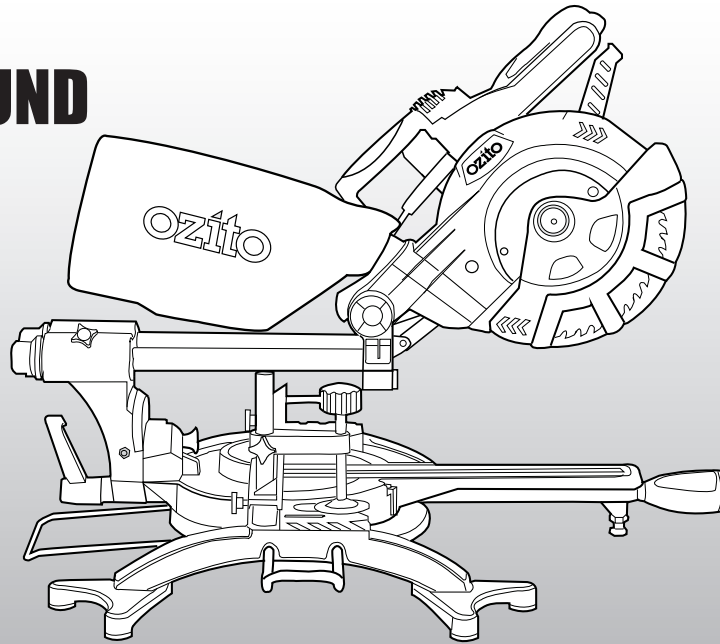

WHAT'S IN THE BOX

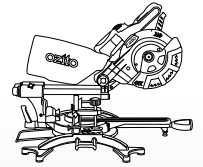

Compound Mitre Saw



Dust Bag

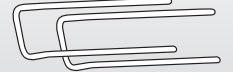

Material Support Bar x 2

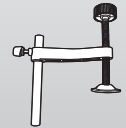

Material Clamp



Hex Key, 5 & 6mm

3

YEAR REPLACEMENT WARRANTY

SCMS-8STAND

WARRANTY

IN ORDER TO MAKE A CLAIM UNDER THIS WARRANTY YOU MUST RETURN THE PRODUCT TO YOUR NEAREST BUNNINGS WAREHOUSE WITH YOUR BUNNINGS REGISTER RECEIPT. PRIOR TO RETURNING YOUR PRODUCT FOR WARRANTY PLEASE TELEPHONE OUR CUSTOMER SERVICE HELPLINE:

Australia 1800 069 486
New Zealand 0508 069 486

TO ENSURE A SPEEDY RESPONSE PLEASE HAVE THE MODEL NUMBER AND DATE OF PURCHASE AVAILABLE. A CUSTOMER SERVICE REPRESENTATIVE WILL TAKE YOUR CALL AND ANSWER ANY QUESTIONS YOU MAY HAVE RELATING TO THE WARRANTY POLICY OR PROCEDURE.

The benefits provided under this warranty are in addition to other rights and remedies which are available to you at law. Our goods come with guarantees that cannot be excluded at law. You are entitled to a replacement or refund for a major failure and for compensation for any other reasonably foreseeable loss or damage. You are also entitled to have the goods repaired or replaced if the goods fail to be of acceptable quality and the failure does not amount to a major failure.

Generally you will be responsible for all costs associated with a claim under this warranty, however, where you have suffered any additional direct loss as a result of a defective product you may be able to claim such expenses by contacting our customer service helpline above.

3 YEAR REPLACEMENT WARRANTY

Your product is guaranteed for a period of 36 months from the original date of purchase and is intended for DIY (Do It Yourself) use only. If a product is defective it will be replaced in accordance with the terms of this warranty. Warranty excludes consumable parts, for example: blade, carbon brushes and dust bag.

WARNING

The following actions will result in the warranty being void.

- If the tool has been operated on a supply voltage other than that specified on the tool.
- If the tool shows signs of damage or defects caused by or resulting from abuse, accidents or alterations.
- Failure to perform maintenance as set out within the instruction manual.
- If the tool is disassembled or tampered with in any way.
- Professional, industrial or high frequency use.

KNOW YOUR PRODUCT

SLIDING MITRE SAW (SCMC-1621)

- | | |
|-----------------------------|------------------------|
| 1. Retractable Safety Guard | 6. Mitre Table Lock |
| 2. Material Support Bar | 7. Bevel Angle Pointer |
| 3. Material Clamp | 8. Lock Down Pin |
| 4. Fence | 9. Spindle Lock Button |
| 5. Mitre Table | 10. Trigger |

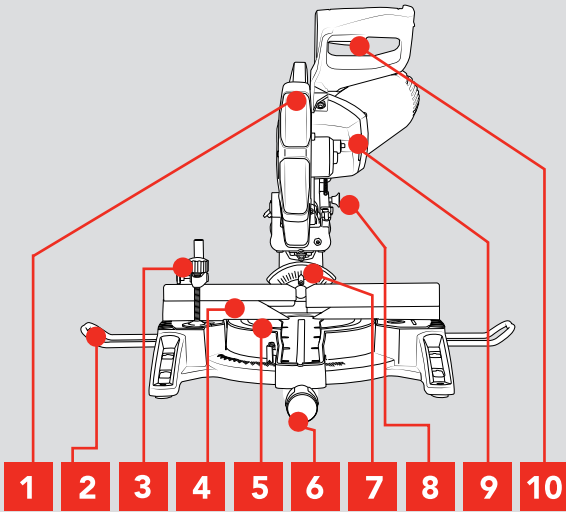

- | | |
|---------------------|-----------------------------|
| 11. Carry Handle | 16. Laser Guide |
| 12. Slide Lock | 17. Additional Support Feet |
| 13. Stabilising Bar | 18. Table Insert |
| 14. Bevel Lock | 19. Release Lever |
| 15. Bevel Release | |

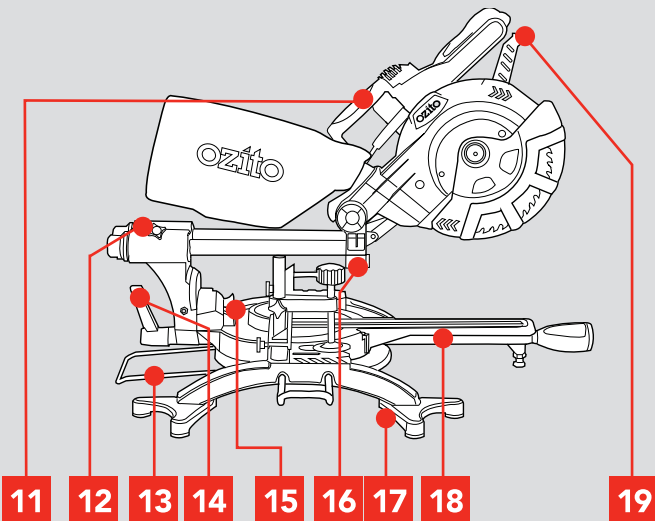

ONLINE MANUAL

Scan this QR Code with your mobile device to take you to the online manual.



SETUP & PREPARATION

1. ASSEMBLY



WARNING!! ENSURE THE TOOL IS SWITCHED OFF AND DISCONNECTED FROM THE POWER SUPPLY BEFORE PERFORMING ANY OF THE FOLLOWING PROCEDURES.

Unpacking

1. Remove foam packaging materials and using the carry handle, carefully lift the mitre saw from its box and place it on a level work surface.
2. Release cutting head from its transport position. While holding the head of the saw down release the lock down pin.

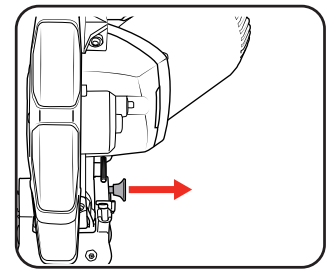
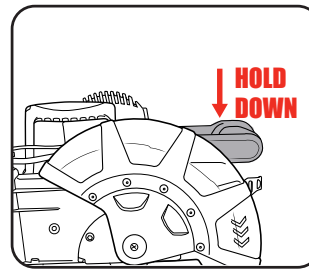

Dust Bag

1. Squeeze the clamp at the end of the dust bag, place over the dust extraction port.

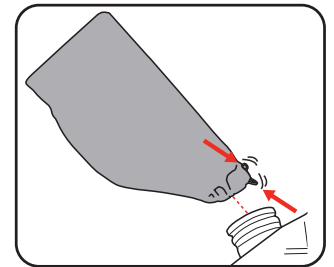

Material Clamp

Material clamp will assist securing timber when making cuts.

Note: The clamp can be mounted on either the left or right.

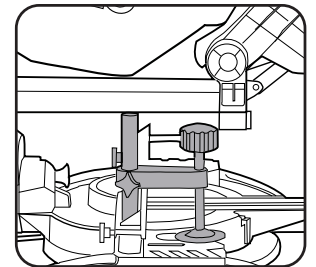

Material Support Bars

1. Insert each bar into the two holes located on both sides of the base.
2. Tighten screw when in place.

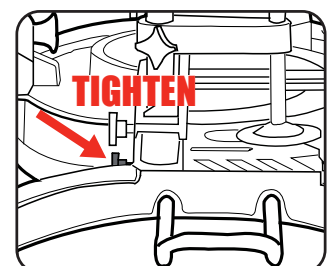
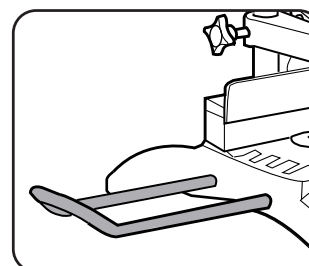

3 YEAR REPLACEMENT WARRANTY

2. SET-UP AND ADJUSTMENTS

Bench Mounting

The base of the saw has four bench mounting holes (1 each corner) that can be used to mount it to a workbench or mitre saw stand. Use four screws or bolts (not included) to secure.

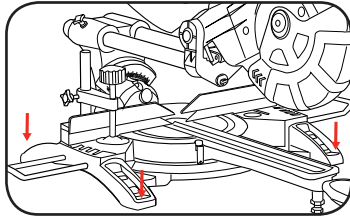

To ensure the saw is standing securely when not mounting to a workbench or mitre saw stand. Screw the Additional Support Feet to the feet of the mitre saw with the fasteners provided. Then swing out the Stabilising Bar to the rear until it engages.

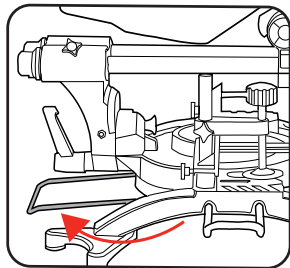
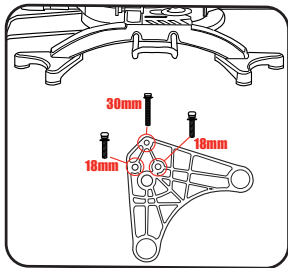

Slide Lock

When cutting a narrow piece of wood it is not necessary to use the slide mechanism. In these circumstances, push back the cutting head and ensure the slide locking knob is tight to prevent the cutting head from sliding.

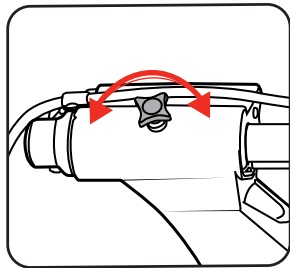

Mitre Angle Adjustment

1. Loosen mitre table lock

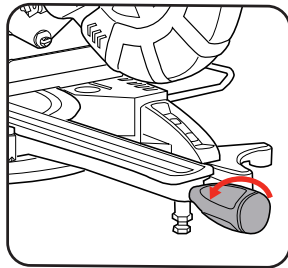

2. Rotate the mitre table to the desired mitre angle (left or right) as shown by the mitre angle pointer

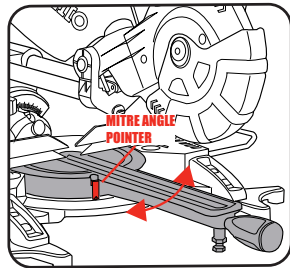

Note: The mitre table features positive click stops at 0°, 15°, 22.5°, 31.6° and 45° for quick setting of common mitre angles.

3. Tighten mitre table lock at selected angle



WARNING! ENSURE THE MITRE TABLE LOCK IS TIGHT BEFORE MAKING A CUT. FAILURE TO DO SO MAY RESULT IN THE MITRE TABLE MOVING DURING OPERATION AND CAUSE SERIOUS PERSONAL INJURY.

Bevel Angle Adjustment

1. Loosen bevel lock.

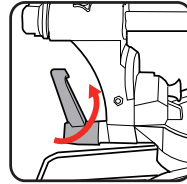

2. **BEVEL LEFT** - Tilt the cutting head to the desired bevel angle left as shown by the bevel angle pointer.

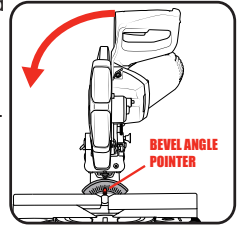

2a. **BEVEL RIGHT** - Tilt the cutting head slightly LEFT then pull the bevel release.

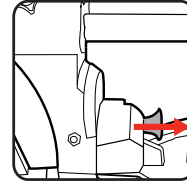

2b. Tilt the cutting head to the desired bevel angle right as shown by the bevel angle pointer.

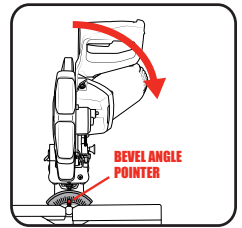

3. Tighten bevel lock at selected angle



WARNING! ENSURE THE BEVEL LOCK IS TIGHT BEFORE MAKING A CUT. FAILURE TO DO SO MAY RESULT IN THE CUTTING HEAD MOVING DURING OPERATION AND CAUSE SERIOUS PERSONAL INJURY.

Trenching

Trenching refers to restricting the depth of cut and permits a "trench" to be cut in the workpiece.

1. Ensure the cutting head is raised, move the trenching stop to the right as far as it will go.

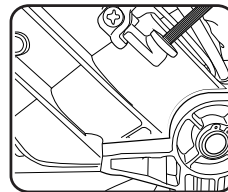

2. To adjust the trenching depth rotate the trenching depth adjustment screw.

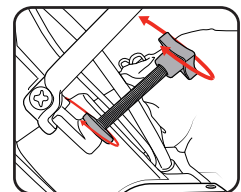

3. To check that the blade stops at the desired position, lower the cutting head until the trenching stop adjustment screw touches the trenching stop.

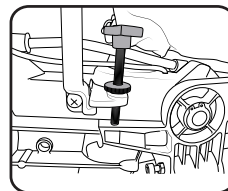

4. When the correct depth is set. Lock it in position using the trenching depth lock nut.

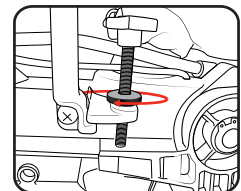

OPERATION

Spindle Lock

The spindle lock prevents the blade in the saw from rotating. Depress and hold the spindle lock while installing, changing, or removing the blade. Never press when blade is rotating.

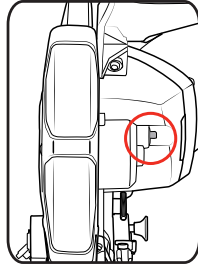

Retractable Safety Guard

The lower guard provides protection to your hands and limbs when the mitre saw head is in the up position. During the operation of the saw, when the saw is turned on and you are making a cut, the lower guard retracts over the upper guard as the saw is lowered into the work piece.

1. To retract the lower guard, slide the release lever right with your thumb and press handle down.

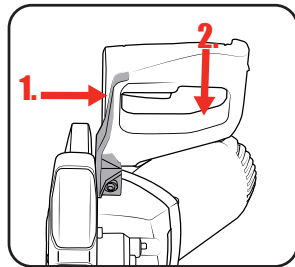

Fence

Make sure that no part of the tool contacts the upper fence when bevel or compound mitre cutting. Always make a dry run with the saw turned off and check clearance. Tighten securely before making a cut.

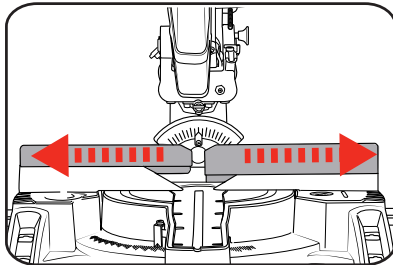

Material Clamp

Depending on the cut, the material clamp will need to be mounted on the appropriate side. When performing bevel cuts, the work clamp must be on the opposite side of the bevel (otherwise it will interfere with the cutting action).

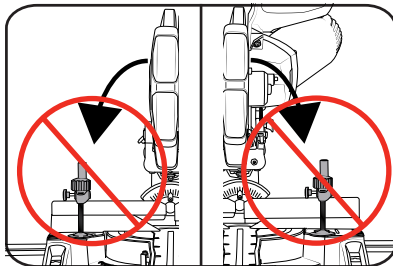

3. TYPES OF CUTS

CAUTION! DO NOT USE THE MITRE SAW TO CUT METAL OR MASONRY.

The tool is recommended for use with a residual current device with a rated residual current of 30mA or less.

When cutting a narrow piece of wood, it is not necessary to use the slide mechanism.

Straight Cutting

A straight cut is made by cutting the grain of the workpiece. A 90° straight cut is made with the mitre scale set in the 0°.

Max. cutting capacity wood:
62 x 310mm

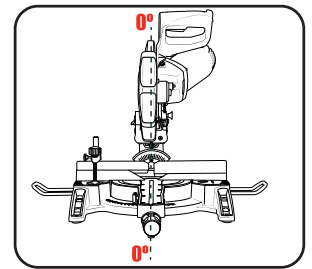
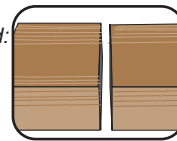

Mitre Cuts

Mitre cuts are made with the mitre scale set at an angle other than 0°

Max. cutting capacity wood:
62 x 210mm

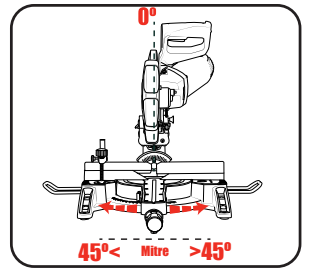
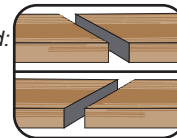

Bevel Cutting

A bevel cut is made by cutting across the grain of the workpiece with the blade angled to the mitre table.

Max. cutting capacity wood:
36 x 310mm

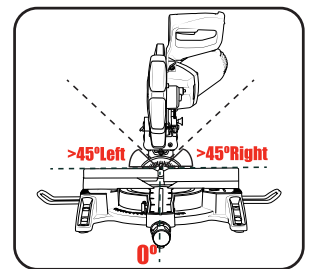
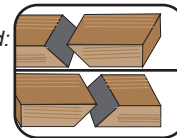

Note: For Bevel Cuts ensure the rear fence is adjusted for blade clearance.

Compound Mitre Cuts

A compound mitre cut involves using a mitre angle and a bevel angle at the same time.

Max. cutting capacity wood:
left 36 x 210mm
right 20 x 210mm

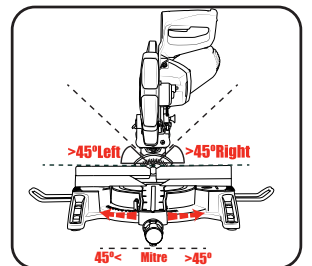
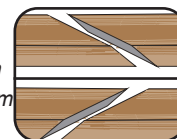

CAUTION! FOR ALL TYPES OF CUTS ENSURE THE SAW IS LOCKED INTO POSITION.

4. OPERATING THE SAW

Turning On and Off

1. To turn the mitre saw on, squeeze the trigger switch
2. To turn the mitre saw off, release the trigger switch

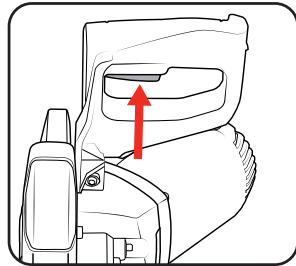

Note: Before performing a cut, ensure the blade is at full speed. Failure to do this may cause the blade to become blunt and cause the blade to lock-up.

Laser Guide



WARNING! DO NOT STARE DIRECTLY AT THE LASER BEAM.

A laser line is projected onto the material you wish to cut, providing an exact guide for the cut.

1. To switch the laser guide on, press the laser guide switch to the On (I) position.
2. To switch the laser guide off, press the laser guide switch to the Off (0) position.

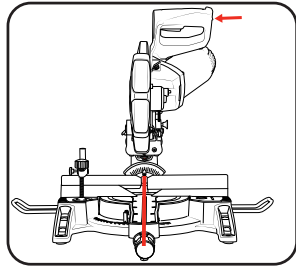

Note: Ensure that the laser guide is switched off when the saw is not in use.

Workpiece

Place the workpiece flat on the mitre table with one edge securely against the rear fence.

Note: If the workpiece is warped, ensure the concave (curves inward) side is against the rear fence.

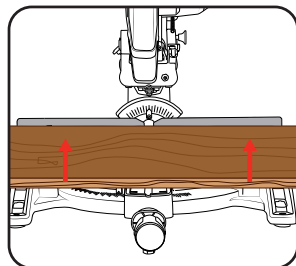

Material Clamp

It is extremely important to always secure the workpiece properly and tightly with the material clamp.

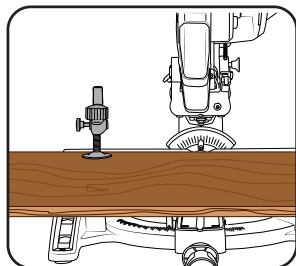

Slide Action

When cutting wide pieces of wood, ensure the slide lock is loose.

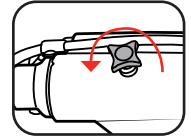

1. First pull carriage fully, slide the release lever right with your thumb and press handle down.

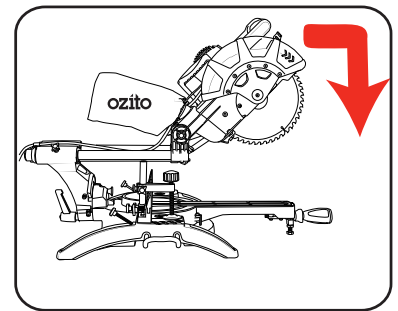

2. Push carriage toward the rear fence.

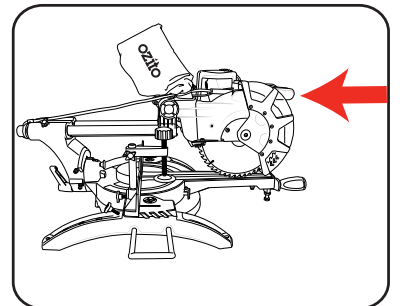

MAINTENANCE



WARNING! BEFORE CLEANING YOUR MITRE SAW OR CARRYING OUT ANY MAINTENANCE PROCEDURE, MAKE SURE THAT THE MOTOR IS OFF AND THE TOOL DISCONNECTED FROM THE POWER SUPPLY TO PREVENT ACCIDENTAL STARTING.

Changing the Blade

CAUTION! NEVER TRY TO USE A BLADE THAT IS LARGER THAN THE STATED CAPACITY OF THE MITRE SAW. IT MIGHT COME INTO CONTACT WITH THE BLADE GUARDS AND RISK PERSONAL INJURY OR DAMAGE TO THE MITRE SAW. THIS WILL NOT BE COVERED UNDER WARRANTY.

CAUTION! NEVER USE A BLADE THAT IS TOO THICK TO ALLOW THE OUTER BLADE WASHER TO ENGAGE WITH THE FLATS ON THE SPINDLE. IT WILL PREVENT THE BLADE SCREW FROM PROPERLY SECURING THE BLADE ONTO THE SPINDLE.

CAUTION! ENSURE THAT THE CORRECT BLADE BUSH THAT MAY BE REQUIRED SUITS THE SPINDLE AND BLADES THAT ARE FITTED.

1. Ensure the plug is disconnected from the mains power supply.
2. Ensure the cutting head is raised. If the head lock down pin is locked in place, pull the head lock down pin and gently raise the cutting head.
3. Raise the lower guard out of the way and hold it
4. Using the 5mm Hex Key loosen the guard cover screw until it disengages the blade bolt cover.
5. Swing the blade bolt cover up and out of the way to reveal the bolt head in the centre of the blade.

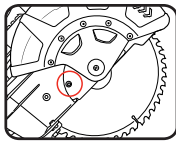

6. Place the 6mm Hex Key onto the blade bolt in the centre of the blade
7. Depress the spindle lock button. To ensure it engages correctly, rotate the Hex Key until the spindle lock clicks into position.

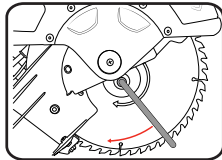

NOTE: The spindle lock button holds the blade in place when using the 6mm Hex Key to change the blade.

8. Loosen the bolt in the centre of the blade by turning the Hex Key clockwise as the blade bolt is a left hand thread.

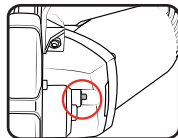

NOTE: Make sure the inner flange stays in place on the spindle.

9. Remove the blade bolt followed by the outer flange. The blade can now be removed by pulling away from the spindle. Put it aside ready to use in the reassembly of the new blade.
10. Install the new blade over the spindle and onto the inner flange
11. Replace the outer flange by placing the cupped side of the flange against the blade followed by the blade bolt.
12. Place the 6mm Hex Key provided onto the blade bolt in the centre of the blade
13. Depress the spindle lock button. To ensure it engages correctly, rotate the Hex Key until the spindle lock clicks into position.
14. Tighten the blade bolt in the centre of the blade by turning the Hex Key anti-clockwise as the blade bolt is a left hand thread.
15. Swing the blade bolt cover back into place and secure it with the guard cover screw.
16. Make sure the lower guard operates smoothly and properly protects from the blade before using the saw.

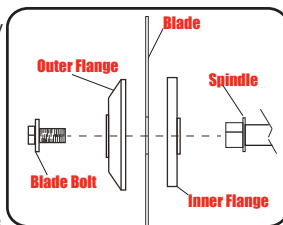

Transportation

The lock down pin is provided for holding the cutting head down whilst transporting or storing the mitre saw. The saw must never be used with the lock down pin locking the head down. Tighten the slide lock during transportation

Carbon Brushes

When the carbon brushes wear out, the mitre saw will spark and/or stop. Discontinue use as soon as this happens. They should be replaced prior to recommencing use of the mitre saw. Carbon brushes are a wearing component of the mitre saw therefore not covered under warranty. Continuing to use the mitre saw when carbon brushes need to be replaced may cause permanent damage to the mitre saw. Carbon brushes will wear out after many uses but when the carbon brushes need to be replaced, take the mitre saw to an electrician or a power tool repairer for a quick and low cost replacement. Always replace both carbon brushes at the same time.

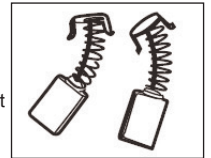

Note: Ozito Industries will not be responsible for any damage or injuries caused by the repair of the mitre saw by an unauthorised person or by mishandling of the mitre saw.

Sparking visible through the housing air vents

A small amount of sparking may be visible through the housing vents. This is normal and does not indicate a problem.

Fence Alignment

The fence holds the workpiece in a fixed position while the table and or the blade assembly are adjusted in a mitre or bevel angle.

To make accurate cuts, the Fence must be perpendicular (at a 90° angle) to the saw blade.

1. Before beginning work, make a test cut on a scrap material with the table set at 90°.
2. Check the cut with an accurate square. You can also reverse the two pieces, hold the cut ends together, and hold a good straight edge along the side of the pieces
3. If either test reveals that the cut is not a true 90° angle, adjust the fence before beginning work.

If Fence Needs Adjustment:

1. First unplug the tool
2. Lower the blade assembly and lock it in place using the Lock Down Pin.
3. Lay a carpenter's square on the turn table one edge along the blade and the other along the fence. Any inaccuracy should be visible. Note: The square must contact the blade, not the teeth, for an accurate reading.
4. The fence is held in place with bolts at each end. Loosen the bolts slightly and, gently tap the fence into position using a soft mallet. Retighten the bolts and make another test cut. Repeat the process until the fence is adjusted accurately.
5. Once the fence is accurately adjusted, tighten the bolts firmly in place. Recheck one last time, then proceed to work.

Dust Bag

Dust extraction port can block easily with dust and requires to be periodically cleaned. For more efficient operation, empty the dust bag when it is no more than half full. This allows better air flow through the bag. Dust bags will not collect all the saw dust generated by the mitre saw. For best results a dust extractor should be used in place of the dust bag.

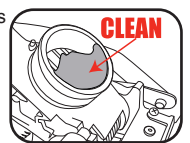









WARNING! TO ENSURE THE CORRECT BLADE ROTATION ALWAYS INSTALL THE BLADE WITH THE BLADE TEETH POINTING DOWNWARDS. ENSURE THE ARROW DIRECTION ON THE BLADE CORRESPONDS WITH THE ARROW ON THE UPPER BLADE GUARD.

TROUBLESHOOTING

PROBLEM	CAUSE	REMEDY
Mitre Saw will not start	No power at power point.	Check power point switch On.
	Cord not connected.	Check that the cord is plugged in.
Mitre Saw operates sporadically or at low power.	Low power supply or improper extension cord.	Inspect power supply or power cords.
	Worn or cracked Carbon Brushes.	Inspect Carbon Brushes. Replace if damaged or worn
Wood burns at ends of cut.	Dirty blade	Clean blade using blade cleaner or mineral spirits.
	Material is binding.	Check position of workpiece on table. Material must be flat, flush against fence and supported on ends
Workpiece frays or chips out	Finished side is down.	Keep finished side of workpiece up or facing operator
	Blade chipped or dull.	Check for damaged teeth. Sharpen or replace blade
	Blade inappropriate for material.	Check blade manufacture's recommendations for material being cut. For cross cutting hardwood and for precision cuts use a thin kerf blade with 60 or more teeth.
	Workpiece is unsupported.	Use a thin piece of scrap material, such as 6mm plywood, underneath or behind the workpiece to support the edges of the workpiece as it is being cut..
Blade binds, slowing or stopping saw	Workpiece is misaligned on the or ends are not supported.	Workpiece must be flat on table, flush against the fence and supported on both ends
	Workpiece is wet, contaminated or inappropriate blade is being used.	Check condition or workpiece and check compatibility of blade to workpiece.
Blade does not cut completely through workpiece.	Depth Stop setting in use.	Move Depth Stop to right to disengage.
	Depth Stop set too shallow.	Adjust Depth Stop Bolt for desired depth of cut.

DESCRIPTION OF SYMBOLS

V	Volts	Hz	Hertz
~	Alternating current	W	Watts
min⁻¹	Revolutions or reciprocation per minute	n	No load speed
	Double insulated		Regulator compliance mark
	Warning		Wear eye protection
	Read instruction manual		Wear hearing protection
	Danger! Keep hands away from blades		Wear safety gloves

CARING FOR THE ENVIRONMENT



Power tools that are no longer usable should not be disposed of with household waste but in an environmentally friendly way. Please recycle where facilities exist. Check with your local council authority for recycling advice.



Recycling packaging reduces the need for landfill and raw materials. Reuse of recycled material decreases pollution in the environment. Please recycle packaging where facilities exist. Check with your local council authority for recycling advice.

SPARE PARTS

Limited spare parts are available subject to availability. Please contact your local Bunnings Special Orders Desk to order the required spare parts.

For further information, or any parts not listed here, visit www.ozito.com.au or contact Ozito Customer Service:

Australia 1800 069 486

New Zealand 0508 069 486

E-mail: enquiries@ozito.com.au

ELECTRICAL SAFETY



WARNING! When using mains-powered tools, basic safety precautions, including the following, should always be followed to reduce risk of fire, electric shock, personal injury and material damage.

Read the whole manual carefully and make sure you know how to switch the tool off in an emergency, before operating the tool.

Save these instructions and other documents supplied with this tool for future reference.

The electric motor has been designed for 230V and 240V only. Always check that the power supply corresponds to the voltage on the rating plate.

Note: The supply of 230V and 240V on Ozito tools are interchangeable for Australia and New Zealand.



This tool is double insulated therefore no earth wire is required.

If the supply cord is damaged, it must be replaced by an electrician or a power tool repairer in order to avoid a hazard.

Note: Double insulation does not take the place of normal safety precautions when operating this tool. The insulation system is for added protection against injury resulting from a possible electrical insulation failure within the tool.

Using an Extension Lead

Always use an approved extension lead suitable for the power input of this tool. Before use, inspect the extension lead for signs of damage, wear and ageing. Replace the extension lead if damaged or defective. When using an extension lead on a reel, always unwind the lead completely. Use of an extension lead not suitable for the power input of the tool or which is damaged or defective may result in a risk of fire and electric shock.

GENERAL POWER TOOL SAFETY WARNINGS - PERSONAL SAFETY

WARNING! Read all safety warnings and all instructions. Failure to follow the warnings and instructions may result in electric shock, fire and/or serious injury. Save all warnings and instructions for future reference. The term "power tool" in the warnings refers to your mains-operated (corded) power tool or battery-operated (cordless) power tool.

1. Work area safety

- Keep work area clean and well lit. Cluttered or dark areas invite accidents.
- Do not operate power tools in explosive atmospheres, such as in the presence of flammable liquids, gases or dust. Power tools create sparks which may ignite the dust or fumes.
- Keep children and bystanders away while operating a power tool. Distractions can cause you to lose control.

2. Electrical safety

- Power tool plugs must match the outlet. Never modify the plug in any way. Do not use any adapter plugs with earthed (grounded) power tools. Unmodified plugs and matching outlets will reduce risk of electric shock.
- Avoid body contact with earthed or grounded surfaces, such as pipes, radiators, ranges and refrigerators. There is an increased risk of electric shock if your body is earthed or grounded.
- Do not expose power tools to rain or wet conditions. Water entering a power tool will increase the risk of electric shock.
- Do not abuse the cord. Never use the cord for carrying, pulling or unplugging the power tool. Keep cord away from heat, oil, sharp edges or moving parts. Damaged or entangled cords increase the risk of electric shock.
- When operating a power tool outdoors, use an extension cord suitable for outdoor use. Use of a cord suitable for outdoor use reduces the risk of electric shock.
- If operating a power tool in a damp location is unavoidable, use a residual current device (RCD) protected supply. Use of an RCD reduces the risk of electric shock.

3. Personal safety

- Stay alert, watch what you are doing and use common sense when operating a power tool. Do not use a power tool while you are tired or under the influence of drugs, alcohol or medication. A moment of inattention while operating power tools may result in serious personal injury.
- Use personal protective equipment. Always wear eye protection. Protective equipment such as dust mask, non-skid safety shoes, hard hat, or hearing protection used for appropriate conditions will reduce personal injuries.
- Prevent unintentional starting. Ensure the switch is in the off-position before connecting to power source and/or battery pack, picking up or carrying the tool. Carrying power tools with your finger on the switch or energising power tools that have the switch on invites accidents.

- Remove any adjusting key or wrench before turning the power tool on. A wrench or a key left attached to a rotating part of the power tool may result in personal injury.
 - Do not overreach. Keep proper footing and balance at all times. This enables better control of the power tool in unexpected situations.
 - Dress properly. Do not wear loose clothing or jewellery. Keep your hair, clothing and gloves away from moving parts. Loose clothes, jewellery or long hair can be caught in moving parts.
 - If devices are provided for the connection of dust extraction and collection facilities, ensure these are connected and properly used. Use of dust collection can reduce dust-related hazards.
- ## 4. Power tool use and care
- Do not force the power tool. Use the correct power tool for your application. The correct power tool will do the job better and safer at the rate for which it was designed.
 - Do not use the power tool if the switch does not turn it on and off. Any power tool that cannot be controlled with the switch is dangerous and must be repaired.
 - Disconnect the plug from the power source and/or the battery pack from the power tool before making any adjustments, changing accessories, or storing power tools. Such preventive safety measures reduce the risk of starting the power tool accidentally.
 - Store idle power tools out of the reach of children and do not allow persons unfamiliar with the power tool or these instructions to operate the power tool. Power tools are dangerous in the hands of untrained users.
 - Maintain power tools. Check for misalignment or binding of moving parts, breakage of parts and any other condition that may affect the power tool's operation. If damaged, have the power tool repaired before use. Many accidents are caused by poorly maintained power tools.
 - Keep cutting tools sharp and clean. Properly maintained cutting tools with sharp cutting edges are less likely to bind and are easier to control.
 - Use the power tool, accessories and tool bits etc. in accordance with these instructions, taking into account the working conditions and the work to be performed. Use of the power tool for operations different from those intended could result in a hazardous situation.
- ## 5. Service
- Have your power tool serviced by a qualified repair person using only identical replacement parts. This will ensure that the safety of the power tool is maintained.

MITRE SAW SAFETY WARNINGS

This appliance is not intended for use by young or infirm persons unless supervised by a responsible person to ensure that they can use the appliance safely. Young children should be supervised to ensure that they do not play with the appliance.



WARNING! Before connecting a tool to a power source (mains switch power point receptacle, outlet, etc.) be sure that the voltage supply is the same as that specified on the nameplate of the tool. A power source with a voltage greater than that specified for the tool can result in serious injury to the user, as well as damage to the tool. If in doubt, do not plug in the tool.

Using a power source with a voltage less than the nameplate rating is harmful to the motor.

Your tool is double insulated for additional protection against a possible electrical insulation failure within the tool.

Always remove the plug from the mains socket before making any adjustments or maintenance, including changing the blade.

- When operating the saw, use safety equipment including safety goggles or shield, ear protection, dust mask and protective clothing including safety gloves.
- Ensure that there is adequate general or localised lighting.
- Do not use the saw unless the guards are in place.
- Do not use the saw to cut metal or masonry.
- Do not let anyone under 18 years operate this saw.
- Ensure that the operator is adequately trained in the use, adjustment and operation of the machine.
- Do not use this saw to cut firewood.
- Keep the area free of tripping hazards.
- Report faults in the machine, including guards and saw blades, as soon as they are discovered.
- Ensure that the machine is always fixed to a bench, whenever possible.
- Always stand to one side when operating the saw.
- Never use a cracked or distorted saw blade.
- When cutting round wood, use clamps that prevent the workpiece from turning on both sides of the blade.
- Never use your hands to remove sawdust, chips or waste close by the blade.
- Do not use blades of High Speed Steel (HSS blades).
- If the table insert is damaged or worn, have it replaced by a power tool repairer.
- Rags, cloths, cord and string and the like should never be left around the work area.
- Avoid cutting nails. Inspect the workpiece and remove all nails and other foreign objects before operating the saw.
- Support the work properly.
- Refrain from removing any cut-offs or other parts of the workpiece from the cutting area whilst the machine is running and the saw head is not in the rest position.

- Do not attempt to free a jammed blade before first switching off the machine.
- Do not slow or stop a blade with a piece of wood. Let the blade come to rest without assistance.
- If you are interrupted when operating the saw, complete the process and switch off before looking up.
- Periodically check that all nuts, bolts and other fixings are properly tightened.
- Do not store materials or equipment above a machine in such a way that they could fall into it.
- Always hold the saw on parts that are insulated. If you accidentally cut into hidden wiring or the saw's own cable, the metal parts of the saw will become "live". Switch off at the mains and remove the plug immediately.
- Never saw near combustible liquids or gases.
- Note the direction of rotation of the motor and the blade.
- Do not lock the movable guard in the open position and always ensure that it is working properly, freely rotating and returning to fully cover the teeth of the blade.
- Connect the saw to a dust collection device and ensure that it is operating properly. As the operator of the saw, please make sure that you understand factors that influence exposure to dust, including the type of material to be cut, the importance of local extraction and the proper adjustment of hoods/baffles/chutes of your dust extraction system. We recommend that you always wear a dust mask when operating this saw.
- Wear gloves when handling saw blades and rough materials.
- Saw blades shall be carried in a holder wherever possible.
- Select saw blades in relation to the material being cut.
- Use correctly sharpened saw blades and observe the maximum speed marked on the blade.
- Take additional care when trenching (slotting).
- The mitre saw can be safely carried by the carrying handle but only once it has been removed from the mains power and secured in the locked down position.
- Ensure that the arm is properly secure when bevelling.
- Keep the floor area around the machine level, well maintained and free of loose materials.
- Ensure that you are trained in the use, adjustment and operation of the machine.
- Do not remove any cut-offs from the cutting area until the mitre saw head is in the full upright position, the blade guard is fully enclosing the blade and the blade has come to a rest or complete stop.
- When cutting long pieces which extend well over the table width, ensure that the ends are adequately supported at the same height as the saw table top. Supports should be positioned in such a way to ensure that the workpiece does not fall to the ground once the cut has been made.

Operating Mitre Saws without the correct hearing protection may result in impairment of hearing.

A number of supports at regular intervals may be required if the workpiece is extremely long.

- Wear goggles
- Wear earmuffs
- Wear a breathing mask

OZITO

SLIDING COMPOUND MITRE SAW & STAND

210mm (8¼")

STAND ASSEMBLY

STAND

- | | |
|------------------------------|-----------------------------|
| 1 Short Upper Support - 2 pc | 4 Long Lower Support - 2 pc |
| 2 Short Lower Support - 2 pc | 5 Upper Leg - 4 pc |
| 3 Long Upper Support - 2 pc | 6 Lower Leg - 4 pc |

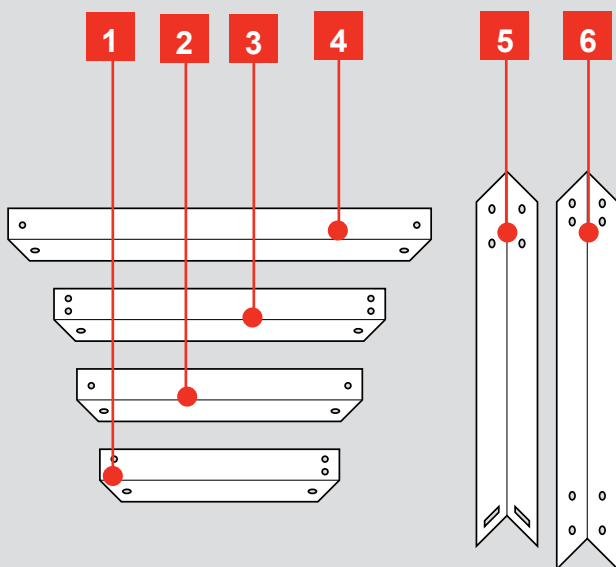

FASTENERS

- | | |
|------------------------|--|
| 7 Bolt Small - 36 pc | 11 Bolt Large with Rubber Stopper - 4 pc |
| 8 Washer Small - 36 pc | 12 Saw Mounting Bolts - 4 pc |
| 9 Nut Small - 36 pc | |
| 10 Rubber Foot - 4 pc | |

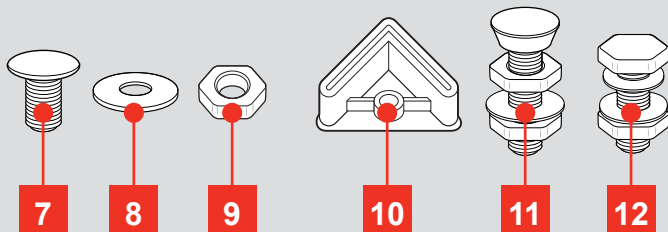

ONLINE MANUAL

Scan this QR Code with your mobile device to take you to the online manual.

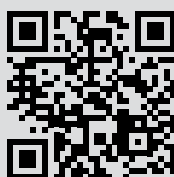

ASSEMBLY OF STAND

The stand is constructed by assembling each half of the structure and then joining them together.

- 1 Remove the stand components from the box and group matching pieces together. Check that you have all the contents listed to the left.

Note: All upper members can be identified by the 2 holes very close together.

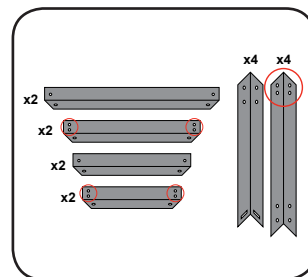

- 2 Lay two upper and lower legs on the ground aligning 2 of the bolt holes, parallel to each other. The upper leg sits outside the lower leg.

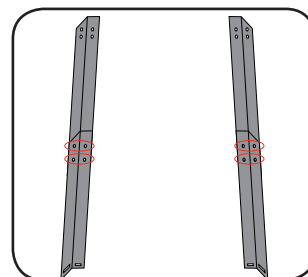

- 3 Place one long lower support in between the legs and align the bolt holes. The side support should have its lip on the high side (facing up) and should sit inside the legs. Ensure the lip with the lengthened bolt holes is facing upwards.

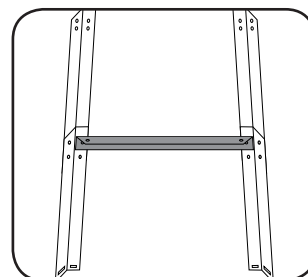

- 4 Once aligned, insert small bolts into the 2 aligned holes at both sides of the lower support. Insert the bolt from the outside and screw a small washer and nut onto each bolt to secure (only hand tight at this initial stage).

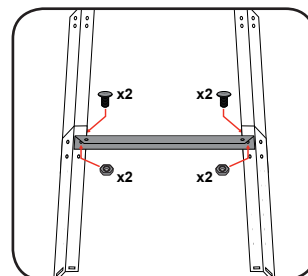

- 5 Place one long upper support on the **outside** of the legs at the top (This will ensure the mounting holes will align correctly once assembled). Insert a bolt from the outside into the 2 aligned holes at either side of the upper support and hand tighten a small washer and nut onto each.

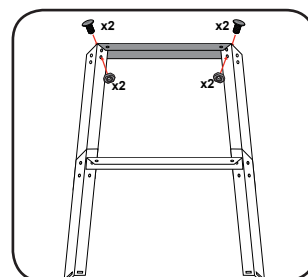

- 6 At this stage your frame should look like this.

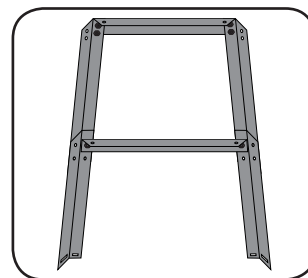

SCMS-8STAND

- 7 Align one short lower support inside the legs at the same height as the long lower support. Ensure that the lip of the side support is facing up.

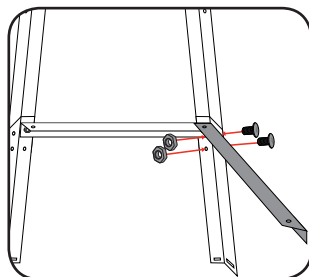

Insert 2 small bolts in the aligned holes from the outside and attaching a small washer and nut (only hand tight at this initial stage).

- 8 On the same side as Step 7, assemble one short upper support to the top of the upper leg using 2 small bolts, washers and nuts. One half of the frame is now complete.

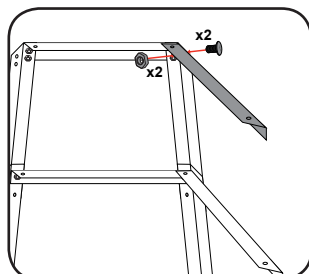

- 9 Repeat the same process for the other side, which should leave you with 2 identical halves.

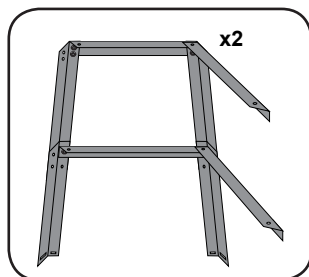

- 10 These halves can now be aligned together to complete the frame.

Note: Nuts & bolts should only be finger tight at this stage.

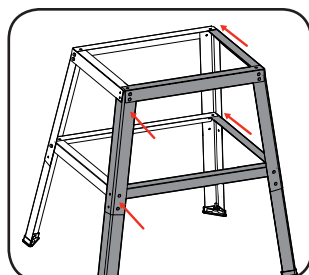

- 11 Align the holes of each opposing member. Bolts, washers and nuts can be inserted & tightened with hand force only.

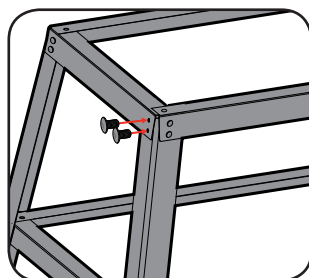

- 12 Insert a bolt into the 4 overlapping lower support holes and attach a washer and nut onto each.

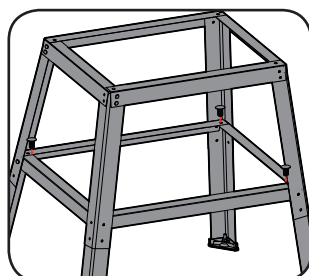

- 12 Once all of the members are joined together and all fasteners are assembled, place the 4 mounting bolts into the holes at the top of the stand. This will ensure the mounting holes align correctly while the stand is tightened. Tighten all nuts and bolts firmly.

Note: We recommend that the stand is mounted to a stable surface for additional stability.

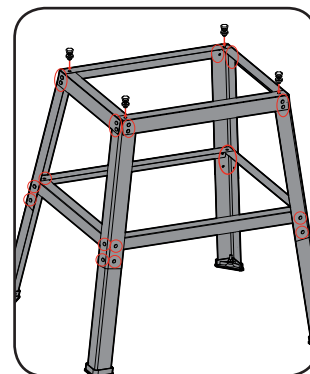

- 13 The Rubber Feet can now be fitted and the large bolts with rubber stops inserted into the rubber feet. These bolts can be adjusted to level the stand.

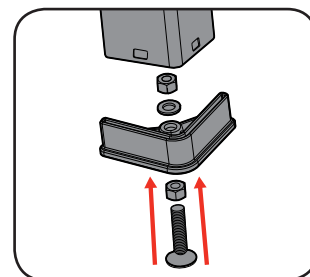

- 14 Remove the mounting bolts that you inserted prior to tightening the stand, then place the saw on the stand. The supplied mounting bolts, washers and nuts should be used to secure the saw to the top of the stand.

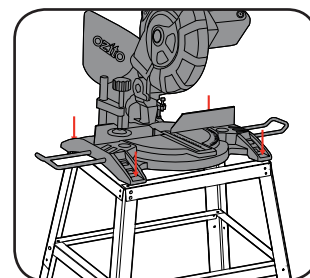

WARNING! ONLY USE THIS STAND WITH THE PROVIDED MITRE SAW OZITO SCMS-1621. THE STAND MUST NOT BE USED WITH OTHER PRODUCTS OR FOR OTHER APPLICATIONS.

