

Zyklop.
The next generation!





More and more, users are demanding tools that are suitable for confined working spaces. Machinery and workpieces are becoming increasingly more compact, and this means that conventional tools are often too big to be effective in such situations.

The Zyklus ratchet, on the market since 2008, can now boast an extension to its own product family. Two unbelievably slim, yet incredibly strong ratchets will provide even greater options to users of all types.

These new ratchets will find their home within the Wera product assortment, grouped together under the Zyklus brand – the ratchet that has been familiar to the market since 2008.



Zyklus Speed

The “original” Zyklus is particularly impressive because it combines 5 types of ratchet into a single tool, and delivers the fastest working speeds. Both features result in making work simpler, and saving time. So with this in mind, the original Zyklus will be known as the Zyklus Speed from now on.



Zyklop Metal

The two new ratchets being introduced are made completely of metal (chrome-molybdenum), so they will be referred to as Zyklop Metal. The new branch of the family will include the Zyklop Metal with a “push-through” square drive and the Zyklop Metal with switch lever.

Zyklop Mini

Filigree design combined with incredible robustness – this is an industrial-strength tool. The Wera Bit Ratchet is used whenever there is insufficient space to work with a power tool or conventional hand tools.

Koloss

The ratchet that can also safely and officially be used as a hammer! The Koloss is a reversible, heavy-duty ratchet that can be used with a load of at least 600 Newton meters.



New set concept.

Wera has developed a completely new “set concept”. Previously, ratchets together with accessories have generally been packed in stable, but bulky and heavy boxes. Our completely new textile boxes offer dramatically improved portability, and are space-saving to boot! This means you can now carry the same collection of tools, in a much more compact and comfortable package.

The hassle of running back and forth for the right tools has now become a thing of the past. And the much lower weight of a set makes carrying more convenient than ever before. The textile box including the tool will even survive a fall undamaged. And: it leaves absolutely no signs of scratches on sensitive surfaces.



Zyklop Metal

Extremely slim. Long leverage.

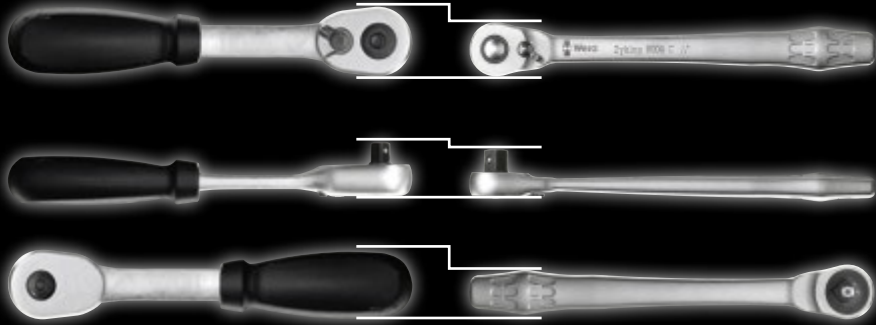

Very robust without any torque limitation.
Forged, full metal ratchet out of chrome molybdenum.

8003 with push-through square

Screwdriving jobs are normally carried out in a single direction. When working with a ratchet, it can sometimes occur that the direction unintentionally switches over. The push-through square that cannot get lost and the secure socket lock mechanism prevent this unintentional switchover of direction.

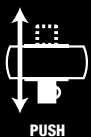

smooth
push-through
mechanism



secure socket
lock mechanism



small
return angle



compact
textile boxes

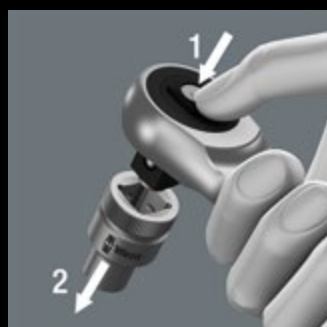



8004 with switch lever

- switch lever for convenient change of direction
- secure socket lock function



SWITCH

switch lever



UNLOCK

secure socket
lock mechanism



FINE
TOOTH

small
return angle



ULTRA
COMPACT

compact
textile boxes







The range







8003 A Zyklop Metal Ratchet with push-through square, 1/4" drive



Code				
	mm	mm	mm	mm
05004003001	1/4"	141,0	21	22





8003 B Zyklop Metal Ratchet with push-through square, 3/8" drive



Code				
	mm	mm	mm	mm
05004033001	3/8"	222,0	27	29

8003 C Zyklop Metal Ratchet with push-through square, 1/2" drive











Code				
	mm	mm	mm	mm
05004063001	1/2"	281,0	36	37











8100 SA 7 Zyklop Metal Ratchet Set with push-through square, 1/4" drive, metric

28-piece set

Code		
05004017001	 8003 A	1 x 1/4"x141,0
	 8790 HMA	1 x 5,0x23,0; 1 x 5,5x23,0; 1 x 6,0x23,0; 1 x 7,0x23,0; 1 x 8,0x23,0; 1 x 10,0x23,0; 1 x 11,0x23,0; 1 x 12,0x23,0; 1 x 13,0x23,0
	 8794 LA	1 x 1/4"x150,0
	 8794 A	1 x 1/4"x56,0
	 8784 A1	1 x 1/4"x1/4"x37,0
	 851/1 Z PH	1 x PH 1x25; 1 x PH 2x25; 1 x PH 3x25
	 855/1 Z PZ	1 x PZ 1x25; 1 x PZ 2x25
	 867/1 Z TORX®	1 x TX 10x25; 1 x TX 15x25; 1 x TX 20x25; 1 x TX 25x25; 1 x TX 27x25; 1 x TX 30x25
	 840/1 Z Hex-Plus	1 x 3,0x25; 1 x 4,0x25; 1 x 5,0x25; 1 x 6,0x25

8100 SA 10 Zyklop Metal Ratchet Set with push-through square, 1/4" drive, imperial

28-piece set

Code		
05004020001	 8003 A	1 x 1/4"x141,0
	 8790 HMA	1 x 3/16"x23,0; 1 x 7/32"x23,0; 1 x 1/4"x23,0; 1 x 9/32"x23,0; 1 x 5/16"x23,0; 1 x 11/32"x23,0; 1 x 3/8"x23,0; 1 x 7/16"x23,0; 1 x 1/2"x23,0
	 8794 LA	1 x 1/4"x150,0
	 8794 A	1 x 1/4"x56,0
	 8784 A1	1 x 1/4"x1/4"x37,0
	 851/1 Z PH	1 x PH 1x25; 1 x PH 2x25; 1 x PH 3x25
	 855/1 Z PZ	1 x PZ 1x25; 1 x PZ 2x25
	 867/1 Z TORX®	1 x TX 10x25; 1 x TX 15x25; 1 x TX 20x25; 1 x TX 25x25; 1 x TX 27x25; 1 x TX 30x25
	 840/1 Z Hex-Plus	1 x 5/32"x25; 1 x 3/16"x25; 1 x 7/32"x25; 1 x 1/4"x25

New: All bits in sets with particularly long-term corrosion protection.



8100 SB 7 Zyklop Metal Ratchet Set with push-through square, $\frac{3}{8}$ " drive, metric

29-piece set

Code		
05004047001	● 8003 B	1 x 3/8"x222,0
	● 8790 HMB	1 x 8,0x29,0; 1 x 10,0x29,0; 1 x 12,0x29,0; 1 x 13,0x29,0; 1 x 15,0x29,0; 1 x 16,0x30,0; 1 x 17,0x30,0; 1 x 18,0x30,0; 1 x 19,0x30,0
	● 8794 LB	1 x 3/8"x200,0
	● 8794 B	1 x 3/8"x76,0
	● 8784 B1	1 x 1/4"x3/8"x44,0
	⊕ 851/1 Z PH	1 x PH 1x25; 1 x PH 2x25; 1 x PH 3x25
	⊕ 855/1 Z PZ	1 x PZ 1x25; 1 x PZ 2x25
	⊕ 867/1 Z TORX®	1 x TX 15x25; 1 x TX 20x25; 1 x TX 25x25; 1 x TX 27x25; 1 x TX 30x25; 1 x TX 40x25
	○ 840/1 Z Hex-Plus	1 x 3,0x25; 1 x 4,0x25; 1 x 5,0x25; 1 x 6,0x25; 1 x 8,0x25



8100 SC 7 Zyklop Metal Ratchet Set with push-through square, $\frac{1}{2}$ " drive, metric

28-piece set

Code		
05004077001	● 8003 C	1 x 1/2"x281,0
	● 8790 HMC	1 x 10,0x37,0; 1 x 11,0x37,0; 1 x 12,0x37,0; 1 x 13,0x37,0; 1 x 14,0x37,0; 1 x 15,0x37,0; 1 x 16,0x37,0; 1 x 17,0x37,0; 1 x 18,0x37,0; 1 x 19,0x37,0
	● 8794 LC	1 x 1/2"x250,0
	● 8794 C	1 x 1/2"x52,0
	● 8784 C2	1 x 5/16"x1/2"x50,0
	⊕ 851/2 Z PH	1 x PH 2x32; 1 x PH 3x32
	⊕ 867/2 Z TORX®	1 x TX 20x35; 1 x TX 25x35; 1 x TX 27x35; 1 x TX 30x35; 1 x TX 40x35; 1 x TX 45x35; 1 x TX 50x35; 1 x TX 55x35
	○ 840/2 Z	1 x 5x30; 1 x 6x30; 1 x 8x30; 1 x 10x30

8100 SB 10 Zyklop Metal Ratchet Set with push-through square, $\frac{3}{8}$ " drive, imperial

29-piece set

Code		
05004050001	● 8003 B	1 x 3/8"x222,0
	● 8790 HMB	1 x 1/4"x29,0; 1 x 5/16"x29,0; 1 x 3/8"x29,0; 1 x 7/16"x29,0; 1 x 1/2"x29,0; 1 x 9/16"x29,0; 1 x 5/8"x30,0; 1 x 11/16"x30,0; 1 x 3/4"x30,0
	● 8794 LB	1 x 3/8"x200,0
	● 8794 B	1 x 3/8"x76,0
	● 8784 B1	1 x 1/4"x3/8"x44,0
	⊕ 851/1 Z PH	1 x PH 1x25; 1 x PH 2x25; 1 x PH 3x25
	⊕ 855/1 Z PZ	1 x PZ 1x25; 1 x PZ 2x25
	⊕ 867/1 Z TORX®	1 x TX 15x25; 1 x TX 20x25; 1 x TX 25x25; 1 x TX 27x25; 1 x TX 30x25; 1 x TX 40x25
	○ 840/1 Z Hex-Plus	1 x 5/32"x25; 1 x 3/16"x25; 1 x 7/32"x25; 1 x 1/4"x25; 1 x 5/16"x25

8100 SC 10 Zyklop Metal Ratchet Set with push-through square, $\frac{1}{2}$ " drive, imperial





28-piece set

Code		
05004080001	● 8003 C	1 x 1/2"x281,0
	● 8790 HMC	1 x 3/8"x37,0; 1 x 7/16"x37,0; 1 x 1/2"x37,0; 1 x 9/16"x37,0; 1 x 19/32"x37,0; 1 x 5/8"x37,0; 1 x 11/16"x37,0; 1 x 3/4"x37,0; 1 x 25/32"x37,0; 1 x 13/16"x37,0
	● 8794 LC	1 x 1/2"x250,0
	● 8794 C	1 x 1/2"x52,0
	● 8784 C2	1 x 5/16"x1/2"x50,0
	⊕ 851/2 Z PH	1 x PH 2x32; 1 x PH 3x32
	⊕ 867/2 Z TORX®	1 x TX 20x35; 1 x TX 25x35; 1 x TX 27x35; 1 x TX 30x35; 1 x TX 40x35; 1 x TX 45x35; 1 x TX 50x35; 1 x TX 55x35
	○ 840/2 Z	1 x 7/32"x30; 1 x 1/4"x30; 1 x 5/16"x30; 1 x 3/8"x30

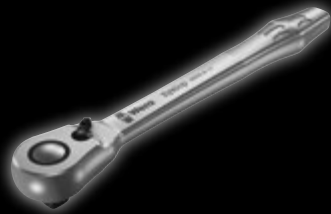
The range





8004 A Zyklop Metal Ratchet with switch lever, 1/4" drive



Code				
		mm	mm	mm
05004004001	1/4"	141,0	19	22









8004 B Zyklop Metal Ratchet with switch lever, 3/8" drive



Code				
		mm	mm	mm
05004034001	3/8"	222,0	26	29

8100 SA 8 Zyklop Metal Ratchet Set with switch lever, 1/4" drive, metric

28-piece set









Code		
05004018001	 8004 A	1 x 1/4"x141,0
	 8790 HMA	1 x 5,0x23,0; 1 x 5,5x23,0; 1 x 6,0x23,0; 1 x 7,0x23,0; 1 x 8,0x23,0; 1 x 10,0x23,0; 1 x 11,0x23,0; 1 x 12,0x23,0; 1 x 13,0x23,0
	 8794 LA	1 x 1/4"x150,0
	 8794 A	1 x 1/4"x56,0
	 8784 A1	1 x 1/4"x1/4"x37,0
	 851/1 Z PH	1 x PH 1x25; 1 x PH 2x25; 1 x PH 3x25
	 855/1 Z PZ	1 x PZ 1x25; 1 x PZ 2x25
	 867/1 Z TORX®	1 x TX 10x25; 1 x TX 15x25; 1 x TX 20x25; 1 x TX 25x25; 1 x TX 27x25; 1 x TX 30x25
	 840/1 Z Hex-Plus	1 x 3,0x25; 1 x 4,0x25; 1 x 5,0x25; 1 x 6,0x25

8004 C Zyklop Metal Ratchet with switch lever, 1/2" drive



8100 SA 11 Zyklop Metal Ratchet Set with switch lever, 1/4" drive, imperial

28-piece set

Code		
05004021001	 8004 A	1 x 1/4"x141,0
	 8790 HMA	1 x 3/16"x23,0; 1 x 7/32"x23,0; 1 x 1/4"x23,0; 1 x 9/32"x23,0; 1 x 5/16"x23,0; 1 x 11/32"x23,0; 1 x 3/8"x23,0; 1 x 7/16"x23,0; 1 x 1/2"x23,0
	 8794 LA	1 x 1/4"x150,0
	 8794 A	1 x 1/4"x56,0
	 8784 A1	1 x 1/4"x1/4"x37,0
	 851/1 Z PH	1 x PH 1x25; 1 x PH 2x25; 1 x PH 3x25
	 855/1 Z PZ	1 x PZ 1x25; 1 x PZ 2x25
	 867/1 Z TORX®	1 x TX 10x25; 1 x TX 15x25; 1 x TX 20x25; 1 x TX 25x25; 1 x TX 27x25; 1 x TX 30x25
	 840/1 Z Hex-Plus	1 x 5/32"x25; 1 x 3/16"x25; 1 x 7/32"x25; 1 x 1/4"x25

New: All bits in sets with particularly long-term corrosion protection.



8100 SB 8 Zyklop Metal Ratchet Set with switch lever, 3/8" drive, metric

29-piece set

Code		
05004048001	● 8004 B	1 x 3/8"x222,0
	● 8790 HMB	1 x 8,0x29,0; 1 x 10,0x29,0; 1 x 12,0x29,0; 1 x 13,0x29,0; 1 x 15,0x29,0; 1 x 16,0x30,0; 1 x 17,0x30,0; 1 x 18,0x30,0; 1 x 19,0x30,0
	● 8794 LB	1 x 3/8"x200,0
	● 8794 B	1 x 3/8"x76,0
	● 8784 B1	1 x 1/4"x3/8"x44,0
	⊕ 851/1 Z PH	1 x PH 1x25; 1 x PH 2x25; 1 x PH 3x25
	⊕ 855/1 Z PZ	1 x PZ 1x25; 1 x PZ 2x25
	⊕ 867/1 Z TORX®	1 x TX 15x25; 1 x TX 20x25; 1 x TX 25x25; 1 x TX 27x25; 1 x TX 30x25; 1 x TX 40x25
	○ 840/1 Z Hex-Plus	1 x 3,0x25; 1 x 4,0x25; 1 x 5,0x25; 1 x 6,0x25; 1 x 8,0x25

8100 SB 11 Zyklop Metal Ratchet Set with switch lever, 3/8" drive, imperial

29-piece set

Code		
05004051001	● 8004 B	1 x 3/8"x222,0
	● 8790 HMB	1 x 1/4"x29,0; 1 x 5/16"x29,0; 1 x 3/8"x29,0; 1 x 7/16"x29,0; 1 x 1/2"x29,0; 1 x 9/16"x29,0; 1 x 5/8"x30,0; 1 x 11/16"x30,0; 1 x 3/4"x30,0
	● 8794 LB	1 x 3/8"x200,0
	● 8794 B	1 x 3/8"x76,0
	● 8784 B1	1 x 1/4"x3/8"x44,0
	⊕ 851/1 Z PH	1 x PH 1x25; 1 x PH 2x25; 1 x PH 3x25
	⊕ 855/1 Z PZ	1 x PZ 1x25; 1 x PZ 2x25
	⊕ 867/1 Z TORX®	1 x TX 15x25; 1 x TX 20x25; 1 x TX 25x25; 1 x TX 27x25; 1 x TX 30x25; 1 x TX 40x25
	○ 840/1 Z Hex-Plus	1 x 5/32"x25; 1 x 3/16"x25; 1 x 7/32"x25; 1 x 1/4"x25; 1 x 5/16"x25



8100 SC 8 Zyklop Metal Ratchet Set with switch lever, 1/2" drive, metric

28-piece set

Code		
05004078001	● 8004 C	1 x 1/2"x281,0
	● 8790 HMC	1 x 10,0x37,0; 1 x 11,0x37,0; 1 x 12,0x37,0; 1 x 13,0x37,0; 1 x 14,0x37,0; 1 x 15,0x37,0; 1 x 16,0x37,0; 1 x 17,0x37,0; 1 x 18,0x37,0; 1 x 19,0x37,0
	● 8794 LC	1 x 1/2"x250,0
	● 8794 C	1 x 1/2"x52,0
	● 8784 C2	1 x 5/16"x1/2"x50,0
	⊕ 851/2 Z PH	1 x PH 2x32; 1 x PH 3x32
	⊕ 867/2 Z TORX®	1 x TX 20x35; 1 x TX 25x35; 1 x TX 27x35; 1 x TX 30x35; 1 x TX 40x35; 1 x TX 45x35; 1 x TX 50x35; 1 x TX 55x35
	○ 840/2 Z	1 x 5x30; 1 x 6x30; 1 x 8x30; 1 x 10x30

8100 SC 11 Zyklop Metal Ratchet Set with switch lever, 1/2" drive, imperial

28-piece set

Code		
05004081001	● 8004 C	1 x 1/2"x281,0
	● 8790 HMC	1 x 3/8"x37,0; 1 x 7/16"x37,0; 1 x 1/2"x37,0; 1 x 9/16"x37,0; 1 x 19/32"x37,0; 1 x 5/8"x37,0; 1 x 11/16"x37,0; 1 x 3/4"x37,0; 1 x 25/32"x37,0; 1 x 13/16"x37,0
	● 8794 LC	1 x 1/2"x250,0
	● 8794 C	1 x 1/2"x52,0
	● 8784 C2	1 x 5/16"x1/2"x50,0
	⊕ 851/2 Z PH	1 x PH 2x32; 1 x PH 3x32
	⊕ 867/2 Z TORX®	1 x TX 20x35; 1 x TX 25x35; 1 x TX 27x35; 1 x TX 30x35; 1 x TX 40x35; 1 x TX 45x35; 1 x TX 50x35; 1 x TX 55x35
	○ 840/2 Z	1 x 7/32"x30; 1 x 1/4"x30; 1 x 5/16"x30; 1 x 3/8"x30

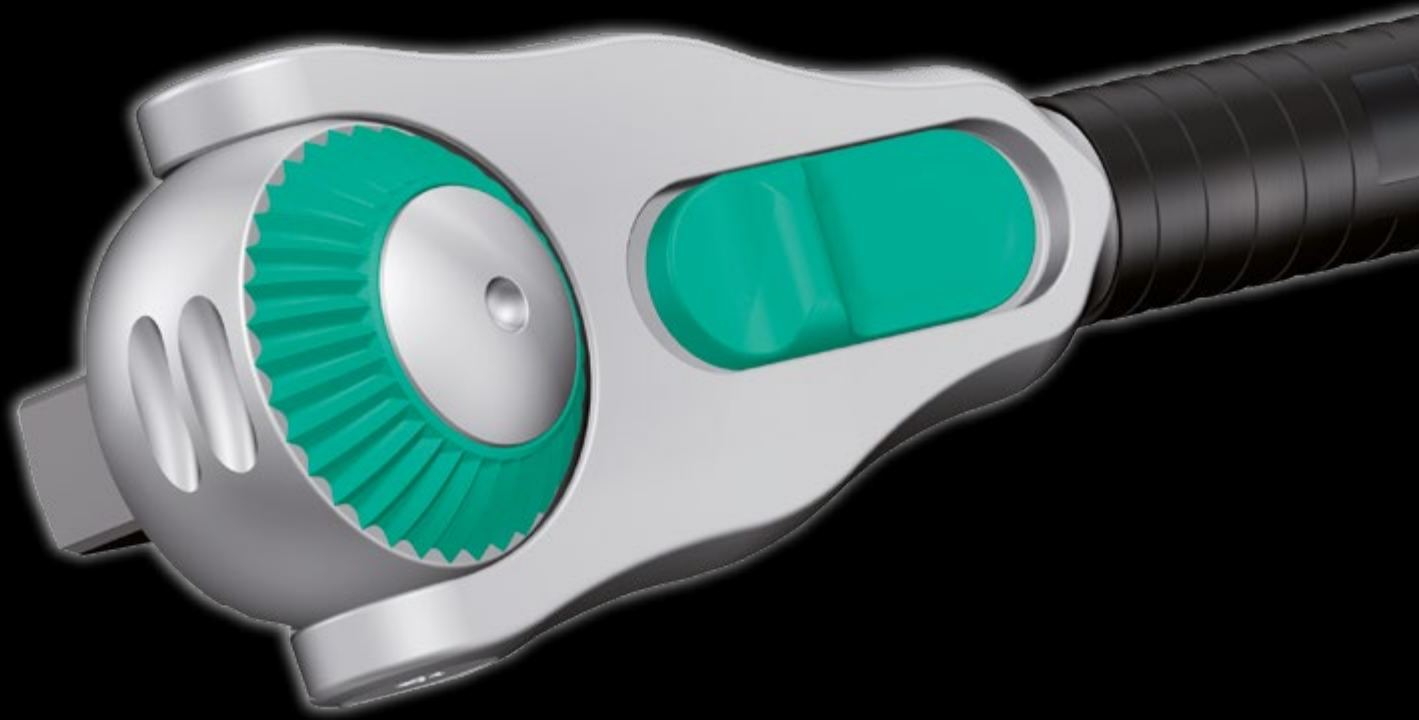

Zyklop Speed

Unbelievably fast and incredibly flexible!

The Zyklop Speed ratchets are really fast movers. The gyrating mass design means that screwdriving is accelerated. The Wera Zyklop ratchet combines five different types of ratchet in one, and you can even use it as a screwdriver:

1. Fine-tooth ratchet
2. Flex-head ratchet
3. Angle ratchet
4. Quick-release ratchet
5. Power ratchet



SPEED

unbelievably
fast



FLEXIBLE
HEAD

ratchet head
pivots freely



FINE
TOOTH

5° small return
angle



SWITCH

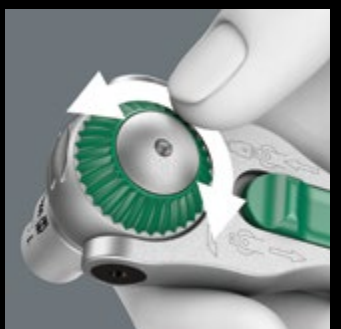

simple
direction change



The Zyklop Speed range



8000 A Zyklop Speed ratchet, 1/4" drive



Code			mm
05003500001	1/4"	152.0	



8000 B Zyklop Speed ratchet, 3/8" drive



Code			mm
05003550001	3/8"	199.0	

8000 C Zyklop Speed ratchet, 1/2" drive



Code			mm
05003600001	1/2"	277.0	



Zyklop Speed sets in textile boxes



8100 SA 6 Zyklop Speed Ratchet Set, 1/4" drive, metric

28-piece set

Code		
05004016001	● 8000 A	1 x 1/4"x152,0
	● 8790 HMA	1 x 5,0x23,0; 1 x 5,5x23,0; 1 x 6,0x23,0; 1 x 7,0x23,0; 1 x 8,0x23,0; 1 x 10,0x23,0; 1 x 11,0x23,0; 1 x 12,0x23,0; 1 x 13,0x23,0
	● 8794 LA	1 x 1/4"x150,0
	● 8794 A	1 x 1/4"x56,0
	● 8784 A1	1 x 1/4"x1/4"x37,0
	⊕ 851/4 TZ PH	1 x PH 1x50; 1 x PH 2x50; 1 x PH 3x50
	⊕ 855/4 TZ PZ	1 x PZ 1x50; 1 x PZ 2x50
	⊕ 867/4 Z TORX®	1 x TX 10x50; 1 x TX 15x50; 1 x TX 20x50; 1 x TX 25x50; 1 x TX 27x50; 1 x TX 30x50
	○ 840/4 Z Hex-Plus	1 x 3,0x50; 1 x 4,0x50; 1 x 5,0x50; 1 x 6,0x50



8100 SB 6 Zyklop Speed Ratchet Set, 3/8" drive, metric

29-piece set

Code		
05004046001	● 8000 B	1 x 3/8"x199,0
	● 8790 HMB	1 x 8,0x29,0; 1 x 10,0x29,0; 1 x 12,0x29,0; 1 x 13,0x29,0; 1 x 15,0x29,0; 1 x 16,0x30,0; 1 x 17,0x30,0; 1 x 18,0x30,0; 1 x 19,0x30,0
	● 8794 LB	1 x 3/8"x200,0
	● 8794 B	1 x 3/8"x76,0
	● 8784 B1	1 x 1/4"x3/8"x44,0
	⊕ 851/4 TZ PH	1 x PH 1x50; 1 x PH 2x50; 1 x PH 3x50
	⊕ 855/4 TZ PZ	1 x PZ 1x50; 1 x PZ 2x50; 1 x PZ 3x50
	⊕ 867/4 Z TORX®	1 x TX 20x50; 1 x TX 25x50; 1 x TX 27x50; 1 x TX 30x50; 1 x TX 40x50
	○ 840/4 Z Hex-Plus	1 x 4,0x50; 1 x 5,0x50; 1 x 6,0x50; 1 x 8,0x50
	● 800/4 Z	1 x 1,0x5,5x50

8100 SA 9 Zyklop Speed Ratchet Set, 1/4" drive, imperial

28-piece set

Code		
05004019001	● 8000 A	1 x 1/4"x152,0
	● 8790 HMA	1 x 3/16"x23,0; 1 x 7/32"x23,0; 1 x 1/4"x23,0; 1 x 9/32"x23,0; 1 x 5/16"x23,0; 1 x 11/32"x23,0; 1 x 3/8"x23,0; 1 x 7/16"x23,0; 1 x 1/2"x23,0
	● 8794 LA	1 x 1/4"x150,0
	● 8794 A	1 x 1/4"x56,0
	● 8784 A1	1 x 1/4"x1/4"x37,0
	⊕ 851/4 TZ PH	1 x PH 1x50; 1 x PH 2x50; 1 x PH 3x50
	⊕ 855/4 TZ PZ	1 x PZ 1x50; 1 x PZ 2x50
	⊕ 867/4 Z TORX®	1 x TX 10x50; 1 x TX 15x50; 1 x TX 20x50; 1 x TX 25x50; 1 x TX 27x50; 1 x TX 30x50
	○ 840/4 Z Hex-Plus	1 x 5/32"x50; 1 x 3/16"x50; 1 x 7/32"x50; 1 x 1/4"x50

8100 SB 9 Zyklop Speed Ratchet Set, 3/8" drive, imperial

29-piece set

Code		
05004049001	● 8000 B	1 x 3/8"x199,0
	● 8790 HMB	1 x 1/4"x29,0; 1 x 5/16"x29,0; 1 x 3/8"x29,0; 1 x 7/16"x29,0; 1 x 1/2"x29,0; 1 x 9/16"x29,0; 1 x 5/8"x30,0; 1 x 11/16"x30,0; 1 x 3/4"x30,0
	● 8794 LB	1 x 3/8"x200,0
	● 8794 B	1 x 3/8"x76,0
	● 8784 B1	1 x 1/4"x3/8"x44,0
	⊕ 851/4 TZ PH	1 x PH 1x50; 1 x PH 2x50; 1 x PH 3x50
	⊕ 855/4 TZ PZ	1 x PZ 1x50; 1 x PZ 2x50; 1 x PZ 3x50
	⊕ 867/4 Z TORX®	1 x TX 20x50; 1 x TX 25x50; 1 x TX 27x50; 1 x TX 30x50; 1 x TX 40x50
	○ 840/4 Z Hex-Plus	1 x 3/16"x50; 1 x 7/32"x50; 1 x 1/4"x50; 1 x 5/16"x50
	● 800/4 Z	1 x 1,0x5,5x50



8100 SC 6 Zyklop Speed Ratchet Set, 1/2" drive, metric

28-piece set

Code		
05004076001	● 8000 C	1 x 1/2"x277,0
	● 8790 HMC	1 x 10,0x37,0; 1 x 11,0x37,0; 1 x 12,0x37,0; 1 x 13,0x37,0; 1 x 14,0x37,0; 1 x 15,0x37,0; 1 x 16,0x37,0; 1 x 17,0x37,0; 1 x 18,0x37,0; 1 x 19,0x37,0
	● 8794 LC	1 x 1/2"x250,0
	● 8794 C	1 x 1/2"x52,0
	● 8784 C2	1 x 5/16"x1/2"x50,0
	⊕ 851/2 Z PH	1 x PH 2x32; 1 x PH 3x32
	⊕ 855/2 Z PZ	1 x PZ 2x32; 1 x PZ 3x32
	⊕ 867/2 Z TORX®	1 x TX 20x35; 1 x TX 25x35; 1 x TX 30x35; 1 x TX 40x35; 1 x TX 45x35; 1 x TX 50x35
	○ 840/2 Z	1 x 5x30; 1 x 6x30; 1 x 8x30; 1 x 10x30

8100 SC 9 Zyklop Speed Ratchet Set, 1/2" drive, imperial

28-piece set

Code		
05004079001	● 8000 C	1 x 1/2"x277,0
	● 8790 HMC	1 x 3/8"x37,0; 1 x 7/16"x37,0; 1 x 1/2"x37,0; 1 x 9/16"x37,0; 1 x 19/32"x37,0; 1 x 5/8"x37,0; 1 x 11/16"x37,0; 1 x 3/4"x37,0; 1 x 25/32"x37,0; 1 x 13/16"x37,0
	● 8794 LC	1 x 1/2"x250,0
	● 8794 C	1 x 1/2"x52,0
	● 8784 C2	1 x 5/16"x1/2"x50,0
	⊕ 851/2 Z PH	1 x PH 2x32; 1 x PH 3x32
	⊕ 855/2 Z PZ	1 x PZ 2x32; 1 x PZ 3x32
	⊕ 867/2 Z TORX®	1 x TX 20x35; 1 x TX 25x35; 1 x TX 30x35; 1 x TX 40x35; 1 x TX 45x35; 1 x TX 50x35
	○ 840/2 Z	1 x 7/32"x30; 1 x 1/4"x30; 1 x 5/16"x30; 1 x 3/8"x30



New: All bits in sets with particularly long-term corrosion protection.

Zyklop Speed sets in strong metal c



8100 SA 1 Zyklop Speed ratchet set, 1/4" drive, metric
18-piece set

Code	
05003532001	<ul style="list-style-type: none"> ○ 8000 A 1 x 1/4"x152,0 ○ 8789 A 1 x 1/4"x110,0 ● 8790 HMA 1 x 4,0x23,0; 1 x 4,5x23,0; 1 x 5,0x23,0; 1 x 5,5x23,0; 1 x 6,0x23,0; 1 x 7,0x23,0; 1 x 8,0x23,0; 1 x 9,0x23,0; 1 x 10,0x23,0; 1 x 11,0x23,0; 1 x 12,0x23,0; 1 x 13,0x23,0; 1 x 14,0x23,0 ●○ 8794 LA 1 x 1/4"x150,0 ●○ 8794 SA 1 x 1/4"x75,0 ●○ 8795 A 1 x 1/4"x35,5

8100 SA 3 Zyklop Speed ratchet set, 1/4" drive, imperial
15-piece set

Code	
05003534001	<ul style="list-style-type: none"> ○ 8000 A 1 x 1/4"x152,0 ○ 8789 A 1 x 1/4"x110,0 ● 8790 HMA 1 x 3/16"x23,0; 1 x 7/32"x23,0; 1 x 1/4"x23,0; 1 x 9/32"x23,0; 1 x 5/16"x23,0; 1 x 11/32"x23,0; 1 x 3/8"x23,0; 1 x 7/16"x23,0; 1 x 1/2"x23,0; 1 x 9/16"x23,0 ●○ 8794 LA 1 x 1/4"x150,0 ●○ 8794 SA 1 x 1/4"x75,0 ●○ 8795 A 1 x 1/4"x35,5



8100 SA 2 Zyklop Speed ratchet set, 1/4" drive, metric
42-piece set

Code	
05003533001	<ul style="list-style-type: none"> ○ 8000 A 1 x 1/4"x152,0 ● 800/1 Z 1 x 0,6x4,5x25; 1 x 1,0x5,5x25; x 1,2x8,0x25 ○ 840/1 Z Hex-Plus 1 x 3,0x25; 1 x 4,0x25; 1 x 5,0x25; 1 x 6,0x25; 1 x 8,0x25 ⊕ 851/1 Z PH 1 x PH 1x25; 1 x PH 2x25; 1 x PH 3x25 ⊕ 855/1 Z PZ 1 x PZ 1x25; 1 x PZ 2x25; 1 x PZ 3x25 ⊕ 867/1 Z TORX® B0 1 x TX 8x25; 1 x TX 9x25; 1 x TX 10x25; 1 x TX 15x25; 1 x TX 20x25; 1 x TX 25x25; 1 x TX 30x25; 1 x TX 40x25 ●○ 8784 A1 1 x 1/4"x1/4"x37,0 ○ 8789 A 1 x 1/4"x110,0 ● 8790 HMA 1 x 4,0x23,0; 1 x 4,5x23,0; 1 x 5,0x23,0; 1 x 5,5x23,0; 1 x 6,0x23,0; 1 x 7,0x23,0; 1 x 8,0x23,0; 1 x 9,0x23,0; 1 x 10,0x23,0; 1 x 11,0x23,0; 1 x 12,0x23,0; 1 x 13,0x23,0; 1 x 14,0x23,0 ●○ 8794 A 1 x 1/4"x56,0 ●○ 8795 A 1 x 1/4"x35,5 ●○ 8796 LA 1 x 1/4"x150,0 ●○ 8796 SA 1 x 1/4"x75,0

8100 SA 4 Zyklop Speed ratchet set, 1/4" drive, imperial
41-piece set

Code	
05003535001	<ul style="list-style-type: none"> ○ 8000 A 1 x 1/4"x152,0 ● 800/1 Z 1 x 0,6x4,5x25; 1 x 1,0x5,5x25; 1 x 1,2x8,0x25 ○ 840/1 Z Hex-Plus 1 x 5/64"x25; 1 x 3/32"x25; 1 x 1/8"x25; 1 x 9/64"x25; 1 x 5/32"x25; 1 x 3/16"x25; 1 x 7/32"x25 ⊕ 851/1 Z PH 1 x PH 1x25; 1 x PH 2x25; 1 x PH 3x25 ⊕ 855/1 Z PZ 1 x PZ 1x25; 1 x PZ 2x25; 1 x PZ 3x25 ⊕ 867/1 Z TORX® B0 1 x TX 8x25; 1 x TX 9x25; 1 x TX 10x25; 1 x TX 15x25; 1 x TX 20x25; 1 x TX 25x25; 1 x TX 30x25; 1 x TX 40x25 ●○ 8784 A1 1 x 1/4"x1/4"x37,0 ○ 8789 A 1 x 1/4"x110,0 ● 8790 HMA 1 x 3/16"x23,0; 1 x 7/32"x23,0; 1 x 1/4"x23,0; 1 x 9/32"x23,0; 1 x 5/16"x23,0; 1 x 11/32"x23,0; 1 x 3/8"x23,0; 1 x 7/16"x23,0; 1 x 1/2"x23,0; 1 x 9/16"x23,0 ●○ 8794 A 1 x 1/4"x56,0 ●○ 8795 A 1 x 1/4"x35,5 ●○ 8796 LA 1 x 1/4"x150,0 ●○ 8796 SA 1 x 1/4"x75,0

New: All bits in sets with particularly long-term corrosion protection.



8100 SB 1 Zyklop Speed ratchet set, 3/8" drive, metric
23-piece set

Code	
05003593001	<ul style="list-style-type: none"> ○ 8000 B 1 x 3/8"x199.0 ○ 8789 B 1 x 3/8"x165.0 ● 8790 HMB 1 x 6.0x29.0; 1 x 7.0x29.0; 1 x 8.0x29.0; 1 x 9.0x29.0; 1 x 10.0x29.0; 1 x 11.0x29.0; 1 x 12.0x29.0; 1 x 13.0x29.0; 1 x 14.0x29.0; 1 x 15.0x29.0; 1 x 16.0x30.0; 1 x 17.0x30.0; 1 x 18.0x30.0; 1 x 19.0x30.0; 1 x 20.0x30.0; 1 x 21.0x30.0; 1 x 22.0x30.0; 1 x 24.0x32.0 ●○ 8794 LB 1 x 3/8"x200.0 ●○ 8794 SB 1 x 3/8"x125.0 ●○ 8795 B 1 x 3/8"x50.0

8100 SB 3 Zyklop Speed ratchet set, 3/8" drive, imperial
17-piece set

Code	
05003595001	<ul style="list-style-type: none"> ○ 8000 B 1 x 3/8"x199.0 ○ 8789 B 1 x 3/8"x165.0 ● 8790 HMB 1 x 1/4"x29.0; 1 x 5/16"x29.0; 1 x 11/32"x29.0; 1 x 3/8"x29.0; 1 x 7/16"x29.0; 1 x 1/2"x29.0; 1 x 9/16"x29.0; 1 x 5/8"x30.0; 1 x 11/16"x30.0; 1 x 3/4"x30.0; 1 x 13/16"x30.0; 1 x 7/8"x30.0 ●○ 8794 LB 1 x 3/8"x200.0 ●○ 8794 SB 1 x 3/8"x125.0 ●○ 8795 B 1 x 3/8"x50.0



8100 SB 2 Zyklop Speed ratchet set, 3/8" drive, metric
43-piece set

Code	
05003594001	<ul style="list-style-type: none"> ○ 8000 B 1 x 3/8"x199.0 ● 800/1 Z 1 x 1.0x5.5x25 ○ 840/1 Z Hex-Plus 1 x 3.0x25; 1 x 4.0x25; 1 x 5.0x25; 1 x 6.0x25; 1 x 8.0x25; 1 x 10.0x25 ⊕ 851/1 Z PH 1 x PH 2x25; 1 x PH 3x25 ⊕ 855/1 Z PZ 1 x PZ 2x25; 1 x PZ 3x25 ⊕ 867/1 Z TORX® BO 1 x TX 10x25; 1 x TX 15x25; 1 x TX 20x25; 1 x TX 25x25; 1 x TX 27x25; 1 x TX 30x25; 1 x TX 40x25 ●○ 8784 B1 1 x 1/4"x3/8"x44.0 ○ 8789 B 1 x 3/8"x165.0 ● 8790 HMB 1 x 6.0x29.0; 1 x 7.0x29.0; 1 x 8.0x29.0; 1 x 9.0x29.0; 1 x 10.0x29.0; 1 x 11.0x29.0; 1 x 12.0x29.0; 1 x 13.0x29.0; 1 x 14.0x29.0; 1 x 15.0x29.0; 1 x 16.0x30.0; 1 x 17.0x30.0; 1 x 18.0x30.0; 1 x 19.0x30.0; 1 x 20.0x30.0; 1 x 21.0x30.0; 1 x 22.0x30.0; 1 x 24.0x32.0 ●○ 8794 B 1 x 3/8"x76.0 ●○ 8795 B 1 x 3/8"x50.0 ●○ 8796 LB 1 x 3/8"x200.0 ●○ 8796 SB 1 x 3/8"x125.0

8100 SB 4 Zyklop Speed ratchet set, 3/8" drive, imperial
38-piece set

Code	
05003596001	<ul style="list-style-type: none"> ● 800/1 Z 1 x 1.0x5.5x25 ○ 840/1 Z Hex-Plus 1 x 5/64"x25; 1 x 3/32"x25; 1 x 1/8"x25; 1 x 9/64"x25; 1 x 5/32"x25; 1 x 3/16"x25; 1 x 7/32"x25 ⊕ 851/1 Z PH 1 x PH 2x25; 1 x PH 3x25 ⊕ 855/1 Z PZ 1 x PZ 2x25; 1 x PZ 3x25 ⊕ 867/1 Z TORX® BO 1 x TX 10x25; 1 x TX 15x25; 1 x TX 20x25; 1 x TX 25x25; 1 x TX 27x25; 1 x TX 30x25; 1 x TX 40x25 ●○ 8784 B1 1 x 1/4"x3/8"x44.0 ○ 8789 B 1 x 3/8"x165.0 ● 8790 HMB 1 x 1/4"x29.0; 1 x 5/16"x29.0; 1 x 11/32"x29.0; 1 x 3/8"x29.0; 1 x 7/16"x29.0; 1 x 1/2"x29.0; 1 x 9/16"x29.0; 1 x 5/8"x30.0; 1 x 11/16"x30.0; 1 x 3/4"x30.0; 1 x 13/16"x30.0; 1 x 7/8"x30.0 ●○ 8794 B 1 x 3/8"x76.0 ●○ 8795 B 1 x 3/8"x50.0 ●○ 8796 LB 1 x 3/8"x200.0 ●○ 8796 SB 1 x 3/8"x125.0



8100 SC 1 Zyklop Speed ratchet set, 1/2" drive, metric

22-piece set

Code	
05003644001	<ul style="list-style-type: none"> ● 8000 C 1 x 1/2"x277.0 ● 8789 C 1 x 1/2"x250.0 ● 8790 HMC 1 x 10.0x37.0; 1 x 11.0x37.0; 1 x 12.0x37.0; 1 x 13.0x37.0; 1 x 14.0x37.0; 1 x 15.0x37.0; 1 x 16.0x37.0; 1 x 17.0x37.0; 1 x 18.0x37.0; 1 x 19.0x37.0; 1 x 20.0x37.0; 1 x 21.0x37.0; 1 x 22.0x37.0; 1 x 24.0x37.0; 1 x 27.0x40.0; 1 x 30.0x42.0; 1 x 32.0x42.0 ● 8794 LC 1 x 1/2"x250.0 ● 8794 SC 1 x 1/2"x125.0 ● 8795 C 1 x 1/2"x69.0

8100 SC 3 Zyklop Speed ratchet set, 1/2" drive, imperial

23-piece set

Code	
05003646001	<ul style="list-style-type: none"> ● 8000 C 1 x 1/2"x277.0 ● 8789 C 1 x 1/2"x250.0 ● 8790 HMC 1 x 3/8"x37.0; 1 x 7/16"x37.0; 1 x 1/2"x37.0; 1 x 9/16"x37.0; 1 x 19/32"x37.0; 1 x 5/8"x37.0; 1 x 11/16"x37.0; 1 x 3/4"x37.0; 1 x 25/32"x37.0; 1 x 13/16"x37.0; 1 x 7/8"x37.0; 1 x 15/16"x37.0; 1 x 31/32"x37.0; 1 x 1"x40.0; 1 x 1 1/16"x40.0; 1 x 1 1/8"x40.0; 1 x 1 3/16"x42.0; 1 x 1 1/4"x42.0 ● 8794 LC 1 x 1/2"x250.0 ● 8794 SC 1 x 1/2"x125.0 ● 8795 C 1 x 1/2"x69.0



8100 SC 2 Zyklop Speed ratchet set, 1/2" drive, metric

37-piece set

Code	
05003645001	<ul style="list-style-type: none"> ● 8000 C 1 x 1/2"x277.0 ● 840/2 Z Hex-Plus 1 x 5x30; 1 x 6x30; 1 x 8x30; 1 x 10x30 ⊕ 851/2 Z PH 1 x PH 3x32 ⊕ 855/2 Z PZ 1 x PZ 3x32 ⊕ 867/2 Z TORX® 1 x TX 20x35; 1 x TX 25x35; 1 x TX 30x35; 1 x TX 40x35; 1 x TX 45x35; 1 x TX 50x35; 1 x TX 55x35 ● 8784 C2 1 x 1/2"x5/16"x50.0 ● 8789 C 1 x 1/2"x250.0 ● 8790 HMC 1 x 10.0x37.0; 1 x 11.0x37.0; 1 x 12.0x37.0; 1 x 13.0x37.0; 1 x 14.0x37.0; 1 x 15.0x37.0; 1 x 16.0x37.0; 1 x 17.0x37.0; 1 x 18.0x37.0; 1 x 19.0x37.0; 1 x 20.0x37.0; 1 x 21.0x37.0; 1 x 22.0x37.0; 1 x 24.0x37.0; 1 x 27.0x40.0; 1 x 30.0x42.0; 1 x 32.0x42.0 ● 8794 C 1 x 1/2"x52.0 ● 8795 C 1 x 1/2"x69.0 ● 8796 LC 1 x 1/2"x250.0 ● 8796 SC 1 x 1/2"x125.0

8100 SC 4 Zyklop Speed ratchet set, 1/2" drive, imperial

38-piece set

Code	
05003647001	<ul style="list-style-type: none"> ● 8000 C 1 x 1/2"x277.0 ● 840/2 Z Hex-Plus 1 x 7/32"x30; 1 x 1/4"x30; 1 x 5/16"x30; 1 x 3/8"x30 ⊕ 851/2 Z PH 1 x PH 3x32 ⊕ 855/2 Z PZ 1 x PZ 3x32 ⊕ 867/2 Z TORX® 1 x TX 20x35; 1 x TX 25x35; 1 x TX 30x35; 1 x TX 40x35; 1 x TX 45x35; 1 x TX 50x35; 1 x TX 55x35 ● 8784 C2 1 x 1/2"x5/16"x50.0 ● 8789 C 1 x 1/2"x250.0 ● 8790 HMC 1 x 3/8"x37.0; 1 x 7/16"x37.0; 1 x 1/2"x37.0; 1 x 9/16"x37.0; 1 x 19/32"x37.0; 1 x 5/8"x37.0; 1 x 11/16"x37.0; 1 x 3/4"x37.0; 1 x 25/32"x37.0; 1 x 13/16"x37.0; 1 x 7/8"x37.0; 1 x 15/16"x37.0; 1 x 31/32"x37.0; 1 x 1"x40.0; 1 x 1 1/16"x40.0; 1 x 1 1/8"x40.0; 1 x 1 3/16"x42.0; 1 x 1 1/4"x42.0 ● 8794 C 1 x 1/2"x52.0 ● 8795 C 1 x 1/2"x69.0 ● 8796 LC 1 x 1/2"x250.0 ● 8796 SC 1 x 1/2"x125.0

New: All bits in sets with particularly long-term corrosion protection.



8100 SA/SC 2 Zyklop Speed ratchet set, 1/4" drive and 1/2" drive, metric

43-piece set

Code	
05160785001	<ul style="list-style-type: none"> ○ 8000 A 1 x 1/4"x152,0 ○ 8000 C 1 x 1/2"x277,0 ● 816 R 1 x 1/4"x119,0 ⊖ 800/4 Z 1 x 1,0x5,5x89 ○ 840/4 Z Hex-Plus 1 x 3,0x89; 1 x 4,0x89; 1 x 5,0x89; 1 x 6,0x89 ⊕ 851/4 Z PH 1 x PH 1x89; 1 x PH 2x89; 1 x PH 3x89 ⊕ 855/4 Z PZ 1 x PZ 1x89; 1 x PZ 2x89; 1 x PZ 3x89 ⊕ 867/4 Z TORX® BO 1 x TX 10x89; 1 x TX 15x89; 1 x TX 20x89; 1 x TX 25x89; 1 x TX 30x89 ● 8784 A1 1 x 1/4"x1/4"x37,0 ● 8790 HMA 1/4" 1 x 4,0x23,0; 1 x 4,5x23,0; 1 x 5,0x23,0; 1 x 5,5x23,0; 1 x 6,0x23,0; 1 x 7,0x23,0; 1 x 8,0x23,0; 1 x 9,0x23,0; 1 x 10,0x23,0; 1 x 12,0x23,0; 1 x 13,0x23,0 ● 8790 HMC 1/2" 1 x 13,0x37,0; 1 x 14,0x37,0; 1 x 15,0x37,0; 1 x 16,0x37,0; 1 x 17,0x37,0; 1 x 18,0x37,0; 1 x 19,0x37,0; 1 x 21,0x37,0; 1 x 22,0x37,0; 1 x 24,0x37,0 ● 8796 LC 1 x 1/2"x250,0 ● 8796 LA 1 x 1/4"x150,0

Zyklop Mini

The Bit Ratchet



EXTRA
SLIM

slim design



6°
FINE
TOOTH

small return
angle



SWITCH

simple
switching



SPEED

thumbwheel enables
rapid screwdriving



FULL
STEEL

incredibly robust
(>65 Nm)



ULTRA
COMPACT

compact sets





8001 A Zyklop Mini Bit Ratchet, 1/4" drive + adaptor for 1/4" sockets

2-piece set

Code		
05073230001	● 8001 A	1 x 1/4"x87,0
	○ 870/1	1 x 1/4"x1/4"x25,0



Bit-Check BR 30 Universal + 8001 A 1/4"

31-piece set

Code		
05073640001	● 8001 A	1 x 1/4"x87,0
	● 889/4/1 K	1 x 1/4"x50,0
	○ 870/1	1 x 1/4"x1/4"x25,0
	● 800/1 TZ	1 x 1,0x5,5x25
	○ 840/1 Z Hex-Plus	1 x 3,0x25; 1 x 4,0x25; 1 x 5,0x25; 1 x 6,0x25; 1 x 8,0x25
	⊕ 851/1 TZ PH	2 x PH 1x25; 3 x PH 2x25; 1 x PH 3x25
	⊕ 855/1 TZ PZ	1 x PZ 1x25; 3 x PZ 2x25; 1 x PZ 3x25
	⊕ 867/1 TZ TORX®	1 x TX 10x25; 1 x TX 15x25; 1 x TX 20x25; 1 x TX 25x25; 1 x TX 30x25; 1 x TX 40x25
	⊕ 867/1 Z TORX® BO	1 x TX 10x25; 1 x TX 15x25; 1 x TX 20x25; 1 x TX 25x25; 1 x TX 30x25



Tool-Check 1

38-piece set

Code		
05073220001	● 8001 A	1 x 1/4"x87,0
	○ 870/1	1 x 1/4"x25
	● 889/4/1 K	1 x 1/4"x50
	⊕ 851/1 TZ PH	2 x PH 1x25; 3 x PH 2x25; 1 x PH 3x25
	⊕ 855/1 TH PZ	1 x PZ 1x25; 3 x PZ 2x25; 1 x PZ 3x25
	⊕ 867/1 TZ TORX®	1 x TX 10x25; 1 x TX 15x25; 1 x TX 20x25; 1 x TX 25x25; 1 x TX 30x25; 1 x TX 40x25
	⊕ 867/1 Z TORX® BO	1 x TX 10x25; 1 x TX 15x25; 1 x TX 20x25; 1 x TX 25x25; 1 x TX 30x25
	● 800/1 TZ	1 x 1,0x5,5x25
	○ 840/1 Z Hex-Plus	1 x 3,0x25; 1 x 4,0x25; 1 x 5,0x25; 1 x 6,0x25; 1 x 8,0x25
	● 8790 HMA	1 x 5,5x23,0; 1 x 6,0x23,0; 1 x 7,0x23,0; 1 x 8,0x23,0; 1 x 10,0x23,0; 1 x 12,0x23,0; 1 x 13,0x23,0



Tool-Check PLUS

39-piece set

Code		
05056490001	● 8001 A	1 x 1/4"x87,0
	● 813	1 x 1/4"x78
	● 889/4/1 K	1 x 1/4"x50
	○ 870/1	1 x 1/4"x25
	● 8790 HMA	1 x 5,5x23,0; 1 x 6,0x23,0; 1 x 7,0x23,0; 1 x 8,0x23,0; 1 x 10,0x23,0; 1 x 12,0x23,0; 1 x 13,0x23,0
	⊕ 851/1 TZ PH	2 x PH 1x25; 3 x PH 2x25; 1 x PH 3x25
	⊕ 855/1 TH PZ	1 x PZ 1x25; 3 x PZ 2x25; 1 x PZ 3x25
	⊕ 867/1 TZ TORX®	1 x TX 10x25; 1 x TX 15x25; 1 x TX 20x25; 1 x TX 25x25; 1 x TX 30x25; 1 x TX 40x25
	⊕ 867/1 Z TORX® BO	1 x TX 10x25; 1 x TX 15x25; 1 x TX 20x25; 1 x TX 25x25; 1 x TX 30x25
	○ 840/1 Z Hex-Plus	1 x 3,0x25; 1 x 4,0x25; 1 x 5,0x25; 1 x 6,0x25; 1 x 8,0x25
	● 800/1 TZ	1 x 1,0x5,5x25

The Zyklop accessories, 1/4"

Flexible-Lock

By activating this system, attachments can be fixed to the extension permanently, preventing slipping and any unintentional loss of the attachment.

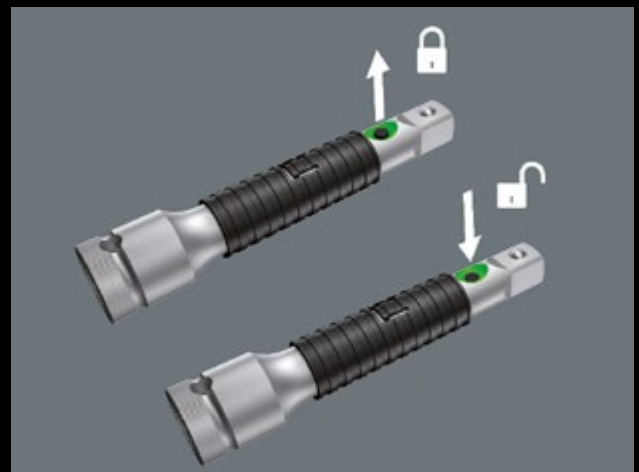

8796 SA Zyklop "flexible-lock" extension with free-turning sleeve, short, 1/4"

Code	mm
05003530001	75.0



8796 LA Zyklop "flexible-lock" extension with free-turning sleeve, long, 1/4"

Code	mm
05003531001	150.0



8790 HMA Zyklop 1/4" socket

Code	mm	mm	mm	mm	mm
05003501001	4.0	23.0	6.9	13.0	10.0
05003502001	4.5	23.0	7.5	13.0	10.0
05003503001	5.0	23.0	8.2	13.0	10.0
05003504001	5.5	23.0	8.8	13.0	10.0
05003505001	6.0	23.0	9.4	13.0	10.0
05003506001	7.0	23.0	11.0	13.0	10.0
05003507001	8.0	23.0	12.0	13.0	10.0
05003508001	9.0	23.0	13.0	14.0	10.0
05003509001	10.0	23.0	14.5	14.5	-
05003510001	11.0	23.0	16.0	15.0	13.0
05003511001	12.0	23.0	17.0	16.0	13.0
05003512001	13.0	23.0	18.0	17.0	13.0
05003513001	14.0	23.0	20.0	18.0	13.0
05003514001	3/16"	23.0	7.5	13.0	10.0
05003515001	7/32"	23.0	8.8	13.0	10.0
05003516001	1/4"	23.0	11.0	13.0	10.0
05003517001	9/32"	23.0	11.0	13.0	10.0
05003518001	5/16"	23.0	12.0	13.0	10.0
05003519001	11/32"	23.0	13.0	14.0	10.0
05003520001	3/8"	23.0	14.5	14.5	-
05003521001	7/16"	23.0	16.0	15.0	13.0
05003522001	1/2"	23.0	18.0	17.0	13.0
05003523001	9/16"	23.0	20.0	18.0	13.0



8789 A Zyklop sliding T-handle, 1/4"

Code	mm
05003524001	110.0



8795 A Zyklop universal joint, 1/4"

Code	mm
05003528001	35.5



8794 SA Zyklop extension with free-turning sleeve, short, 1/4"

Code	mm
05003525001	75.0



8794 A Zyklop wobble extension, 1/4"

Code	mm
05003527001	56.0



8794 LA Zyklop extension with free-turning sleeve, long, 1/4"

Code	mm
05003526001	150.0



8784 A1 Zyklop adaptor, 1/4"

Code	mm
05003529001	37.0

The Zyklop accessories, 3/8"



8790 HMB Zyklop
3/8" socket

Code	mm	mm	mm	mm	mm
05003551001	6.0	29.0	10.5	13.0	18.0
05003552001	7.0	29.0	11.0	13.0	18.0
05003553001	8.0	29.0	12.2	13.0	18.0
05003554001	9.0	29.0	13.5	13.0	18.0
05003555001	10.0	29.0	14.5	13.0	18.0
05003556001	11.0	29.0	16.0	13.0	18.0
05003557001	12.0	29.0	17.0	13.0	18.0
05003558001	13.0	29.0	18.5	14.0	20.0
05003559001	14.0	29.0	19.5	14.5	22.0
05003560001	15.0	29.0	21.0	15.0	24.0
05003561001	16.0	30.0	22.0	16.0	24.0
05003562001	17.0	30.0	23.5	17.0	24.0
05003563001	18.0	30.0	24.5	18.0	24.0
05003564001	19.0	30.0	26.0	13.0	24.0
05003565001	20.0	30.0	28.0	13.0	25.0
05003566001	21.0	30.0	28.0	13.0	25.0
05003567001	22.0	30.0	32.0	13.0	25.0
05003568001	24.0	32.0	32.0	13.0	25.0
05003569001	1/4"	29.0	11.0	18.0	12.0
05003570001	5/16"	29.0	12.2	18.0	12.0
05003571001	11/32"	29.0	13.5	18.0	12.0
05003572001	3/8"	29.0	14.5	18.0	12.0
05003573001	7/16"	29.0	16.0	18.0	12.0
05003574001	1/2"	29.0	18.5	20.0	12.0
05003575001	9/16"	29.0	19.5	22.0	12.0
05003576001	5/8"	30.0	22.0	24.0	12.0
05003577001	11/16"	30.0	23.0	24.0	18.0
05003578001	3/4"	30.0	26.0	24.0	18.0
05003579001	13/16"	30.0	28.0	25.0	18.0
05003580001	7/8"	30.0	32.0	25.0	18.0

The manual and machine sockets (ISO 2725-Part 3) can be used both for hand and power tools use (non-impact). Users need just one socket set for all applications.



8796 SB Zyklop "flexible-lock" extension with free-turning sleeve, short, 3/8"

Code	mm
05003591001	125.0





8796 LB Zyklop "flexible-lock" extension with free-turning sleeve, long, 3/8"

Code	mm
05003592001	200.0





8789 B Zyklop sliding T-handle, 3/8"

Code			mm
05003581001	3/8"		165.0





8795 B Zyklop universal joint, 3/8"

Code			mm
05003585001	3/8"		50.0





8794 SB Zyklop extension with free-turning sleeve, short, 3/8"

Code			mm
05003582001	3/8"		125.0





8794 B Zyklop wobble extension, 3/8"

Code			mm
05003584001	3/8"		76.0





8794 LB Zyklop extension with free-turning sleeve, long, 3/8"

Code			mm
05003583001	3/8"		200.0









8784 B1 Zyklop adaptor, 3/8"

Code				mm
05003590001	1/4"	3/8"		44.0

The Zyklop accessories, 1/2"





8790 HMC Zyklop
1/2" socket

Code						
Code	mm		mm	mm	mm	mm
05003601001	10.0		37.0	15.5	24.0	17.0
05003602001	11.0		37.0	16.5	24.0	17.0
05003603001	12.0		37.0	17.5	24.0	17.0
05003604001	13.0		37.0	19.0	24.0	17.0
05003605001	14.0		37.0	20.0	24.0	17.0
05003606001	15.0		37.0	21.0	24.0	17.0
05003607001	16.0		37.0	22.5	24.0	17.0
05003608001	17.0		37.0	24.0	26.0	17.0
05003609001	18.0		37.0	25.0	26.0	17.0
05003610001	19.0		37.0	26.5	26.0	20.0
05003611001	20.0		37.0	28.0	26.0	20.0
05003612001	21.0		37.0	29.0	26.0	20.0
05003613001	22.0		37.0	30.5	26.0	20.0
05003614001	24.0		37.0	33.0	28.0	20.0
05003615001	27.0		40.0	36.5	32.0	23.0
05003616001	30.0		42.0	40.0	34.0	25.0
05003617001	32.0		42.0	42.0	36.0	25.0
05003618001		3/8"	37.0	15.5	24.0	17.0
05003619001		7/16"	37.0	16.5	24.0	17.0
05003620001		1/2"	37.0	19.0	24.0	17.0
05003621001		9/16"	37.0	20.0	24.0	17.0
05003622001		19/32"	37.0	21.0	24.0	17.0
05003623001		5/8"	37.0	22.5	24.0	17.0
05003624001		11/16"	37.0	25.5	26.0	17.0
05003625001		3/4"	37.0	26.5	26.0	20.0
05003626001		25/32"	37.0	28.0	26.0	20.0
05003627001		13/16"	37.0	29.0	26.0	20.0
05003628001		7/8"	37.0	30.5	26.0	20.0
05003629001		15/16"	37.0	33.0	28.0	20.0
05003630001		31/32"	37.0	33.0	28.0	20.0
05003631001		1"	40.0	36.5	32.0	23.0
05003632001		1 1/16"	40.0	36.5	32.0	23.0
05003633001		1 1/8"	40.0	40.0	34.0	23.0
05003634001		1 3/16"	42.0	40.0	34.0	25.0
05003635001		1 1/4"	42.0	42.0	36.0	25.0

The Zyklop wobble extensions pivot through 15° in all directions. This enables rapid and precise work in concealed or confined installation areas.





8796 SC Zyklop "flexible-lock" extension with free-turning sleeve, short, 1/2"

Code			mm
05003642001	1/2"	125.0	



8796 LC Zyklop "flexible-lock" extension with free-turning sleeve, long, 1/2"

Code			mm
05003643001	1/2"	250.0	



8789 C Zyklop T-handle, 1/2"

Code	mm
05003638001	250.0



8795 C Zyklop universal joint, 1/2"

Code	mm
05003640001	69.0



8794 SC Zyklop extension with free-turning sleeve, short, 1/2"

Code	mm
05003637001	125.0



8794 C Zyklop wobble extension, 1/2"

Code	mm
05003639001	52.0



8794 LC Zyklop extension with free-turning sleeve, long, 1/2"

Code	mm
05003638001	250.0



8784 C2 Zyklop adaptor, 1/2", 5/16"

Code	mm
05003641001	50.0

Koloss

The ratchet with hammer function



hammer
function



push-through
square



dual ratchet
teeth



A ratchet is often improperly used as a hammer – particularly when things need to be done quickly. This causes damage to the ratchet head and it quickly becomes unfit for use.

The solution for this problem is the Koloss from Wera – the ratchet that can also safely and officially be used as a hammer! The Koloss is a reversible, heavy-duty ratchet that can be used with a load of at least 600 Newton meters. Dual ratchet teeth: gives the robust 30 saw teeth the precision engineering effect of 60 fine teeth with a 6° return angle.

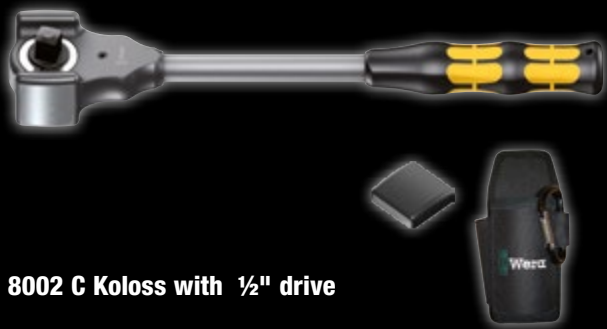

8002 C Koloss with 1/2" drive

Code		
05073232001	8002 C	1 x 1/2"x341,0
	8782 C	1 x 50,0x50,0
	Holster	1 x



8780 C Koloss extension

Code	mm
05003695001	341,0

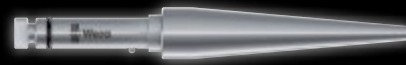

8781 C Koloss centring pin

Code	mm	mm	mm
05003696001	135,0	85,0	5,3-18,0



8002 C Koloss 1/2" all inclusive Set SB

Code		
05133862001	8002 C	1 x 1/2"x341,0
	8782 C	1 x 50,0x50,0
	8780 C	1 x Koloss extension
	Extension release pin	1 x
	Holster	1 x

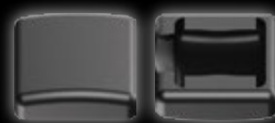

8782 C Koloss pad set

Code		
05003697001	8782 C	2 x 50,0x50,0



Wera Werk · Germany
Korzerter Straße 21–25
D-42349 Wuppertal

Phone: +49 (0)2 02 / 40 45-322
Fax: +49 (0)2 02 / 40 36 34
E-Mail: info@wera.de

www.wera.de
www.weratools.com