

OPERATION

7. SWITCHING ON/OFF

Switching On

1. Hold the pruner firmly with both hands.

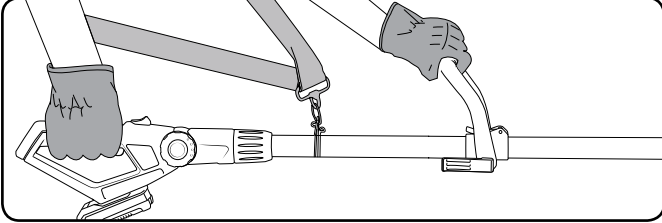

2. Slide the switch lock (a) to the front with your thumb and hold, then squeeze the trigger switch (b).
3. The chain will now be running ready to make a cut. Release the switch lock (a).

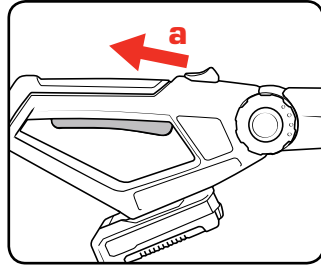
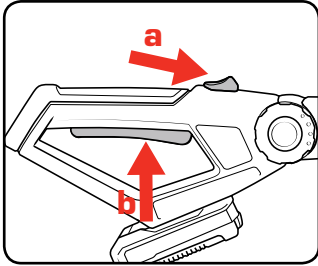

Switching Off

3. Release the trigger switch. The chain and motor will quickly stop.

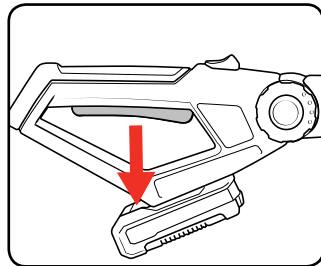

APPLICATIONS

WARNING! IF THE CHAIN COMES IN CONTACT WITH A HARD OBJECT, VISUALLY INSPECT THE CHAIN & BAR FOR DAMAGE. IF THE CHAIN OR BAR IS DAMAGED, DO NOT CONTINUE TO OPERATE THE POLE PRUNER.

WARNING! NEVER USE THE POLE PRUNER WHEN STANDING ON A LADDER OR UNEVEN GROUND. DO NOT OVERREACH. ALWAYS USE BOTH HANDS TO HOLD THE POLE PRUNER.

CAUTION: ALWAYS USE THE BUCKING SPIKES WHEN PERFORMING CUTS WITH THE POLE PRUNER TO AVOID KICKBACK (REFER TO OPERATION SECTION OF MANUAL).

CAUTION: ENSURE APPROPRIATE CARE IS TAKEN WHEN CUTTING ABOVE SHOULDER HEIGHT.

Limbing

- Limbing is the process of removing the branches from a fallen tree. Check the direction in which a branch will bend before cutting it. Always cut on the opposite side to the bending direction so that the guide bar is not pinched in the cut. For large limbs that cannot be removed in one cut, make an initial cut from the bent side and finish by sawing from the opposite direction. Do not remove limbs that are supporting the fallen tree on the ground until the tree has been cut into lengths.

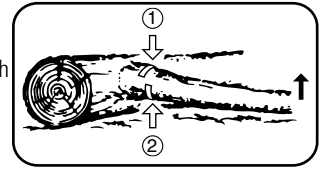

Pruning

- Pruning is the removal of a limb or branch from a standing tree.

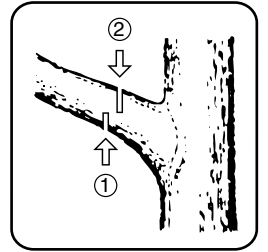

Sawing Techniques

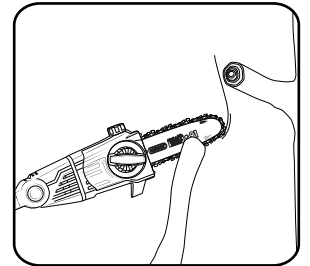
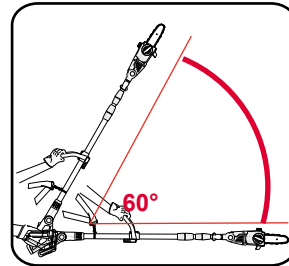

- When removing branches, hold the pruner at an angle ranging from a maximum 60° to horizontal in order to avoid being struck by a falling branch.
- At the end of the cut, the weight of the pruner suddenly increases for the user, because it is no longer supported on the branch. There is the risk of losing control of the pruner.

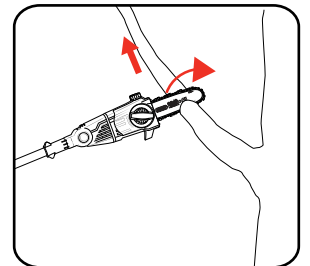
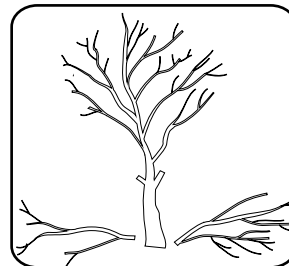

- Saw off the lower branches on the tree first. By doing so, it is easier for the cut branches to fall to the ground.
- Only pull the pruner out of the cut with the chain running. By doing so, you can prevent it from getting jammed.

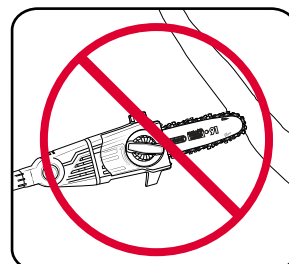

- Do not saw with the tip of the guide bar. This could lead to kick back and possible injury.

MAINTENANCE

WARNING: BEFORE CLEANING YOUR POLE PRUNER OR CARRYING OUT ANY MAINTENANCE PROCEDURE, MAKE SURE THAT THE MOTOR IS OFF AND THE BATTERY REMOVED TO PREVENT ACCIDENTAL STARTING.

CAUTION: ALWAYS WEAR GLOVES WHEN HANDLING THE CHAIN AS IT IS VERY SHARP AND CAN CUT YOU WHEN IT IS NOT MOVING.

Maintaining the guide bar

1. Remove any sawdust from the guide bar, including the groove. Oil and sawdust combine and emit a burning smell during operation if the blade is not regularly cleaned.
2. Make sure that the oil port is not clogged. Grease the nose sprocket at the tip of the guide bar.
3. Check for oil leakage and loose fastenings, especially those securing the handles and the guide bar.
4. Reverse the guide bar every 8 working hours to ensure uniform wear. Check the guide rails frequently and if necessary remove burrs and square up the rails using a flat file.

Chain Sharpening

Chain File: 3.96mm (5/32")

Chain Pitch: 9.53mm (3/8")

Chain Gauge: 1.3mm (0.050")

Sharpen the chain regularly to maintain optimum performance of the saw. Signs of a dull chain are:

- The sawdust becomes powder-like
- Extra force is required to execute a cut
- The cut does not track in a straight line
- Increased vibration

Sharpen each cutter using a round 3.96mm (5/32") chain file. Keep the file level with the top plate of the tooth. Always use outward strokes and maintain a 30° angle between the chain and file. After sharpening, the cutters must all have the same width and length.

After every 3–4 uses get an authorised repair centre to professionally sharpen your chain. They have the special tools necessary to ensure the correct cutting angles and depths.

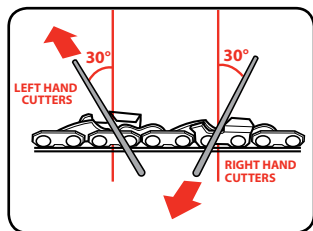

SPARE PARTS

Chain Replacement:

The chain can be purchased through Ozito spare parts or from your local Bunnings Warehouse. The correct chain can be purchased by matching the pitch, gauge and number of links as shown below:

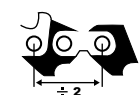

9.53 mm (3/8)



1.3 mm (0.050")



33 Links

Spare parts can be ordered from the Special Orders Desk at your local Bunnings Warehouse.

For further information, or any parts not listed here, visit www.ozito.com.au or contact Ozito Customer Service:

Australia 1800 069 486

New Zealand 0508 069 486

E-mail: enquires@ozito.com.au

DESCRIPTION OF SYMBOLS

| | | | |
|--------|--|---|-----------------------------------|
| dc/--- | Direct current | V | Volts |
| /min | Revolutions or reciprocation per minute | | Double insulated |
| | Regulator compliance mark | | Transformer Energy Rating (MEPS) |
| | Read instruction manual | | Wear eye, ear and head protection |
| | Wear safety gloves | | Keep bystanders away |
| No | No load speed | | Warning |
| | Wear safety boots | | Sound pressure level |
| | Do not saw in the rain or leave the pole pruner outdoors while raining. | | |
| | Maintain a minimum clearance of 10 m from current-carrying lines. Life-threatening danger from electric shock. | | |

BATTERY AND CHARGER SAFETY WARNINGS

THIS MANUAL CONTAINS IMPORTANT SAFETY AND OPERATING INSTRUCTIONS FOR YOUR BATTERY CHARGER.

1. Before using the charger read all instructions and cautionary markings on the charger, battery pack and the product using the battery pack.
2. This charger is not intended for any uses other than charging rechargeable batteries. Any other use may result in risk of fire, electric shock or electrocution.
3. Do not place any object on top of the charger or place the charger on a soft surface that may result in excessive internal heat. Place the charger in a position away from any heat source.
4. To reduce risk of damage to the electric plug and cord, pull by the plug rather than the cord when disconnecting the charger.
5. Make sure the cord is located so that it will not be stepped on, tripped over, or otherwise subjected to damage or stress.
6. An extension cord should not be used unless absolutely necessary. Use of an improper extension cord could result in the risk of fire, electric shock or electrocution.
7. Do not operate the charger if it has received a sharp blow, been dropped or otherwise damaged in any way. Have it checked by an electrician or power tool repairer.
8. Do not disassemble charger. Take it to an electrician or power tool repairer when service or repair is required. Incorrect reassembly may result in a risk of electric shock, electrocution or fire.
9. To reduce risk of electric shock, unplug the charger from the outlet before attempting any cleaning. Removing the battery pack will not reduce this risk.
10. Never attempt to connect 2 chargers together.
11. DO NOT store or use the tool and battery pack in locations where the temperature may reach or exceed 40°C (such as inside sheds or metal buildings in summer).
12. The charger is designed to operate on standard household electrical power (240 volts). Do not attempt to use it on any other voltage!
13. The battery pack is not fully charged out of the carton. First read the safety instructions and then follow the charging notes and procedures.
14. The longest life and best performance can be obtained if the battery pack is charged when the air temperature is between 18 - 24°C. Do not charge the battery pack in an air temperature below 10°C or above 40°C. This is important and will prevent damage to the battery pack.
15. Do not incinerate the battery pack even if it is seriously damaged or is completely worn out. The battery can explode in a fire.
16. Never attempt to open the battery pack for any reason. If the plastic housing of the battery pack breaks or cracks, immediately discontinue use and do not recharge.
17. During charging, the battery must be placed in a well ventilated area.

CARING FOR THE ENVIRONMENT



Power tools that are no longer usable should not be disposed of with household waste but in an environmentally friendly way. Please recycle where facilities exist. Check with your local council authority for recycling advice.



Recycling packaging reduces the need for landfill and raw materials. Reuse of recycled material decreases pollution in the environment. Please recycle packaging where facilities exist. Check with your local council authority for recycling advice.



ELECTRICAL SAFETY



WARNING! When using mains-powered tools, basic safety precautions, including the following, should always be followed to reduce risk of fire, electric shock, personal injury and material damage.

Read the whole manual carefully and make sure you know how to switch the tool off in an emergency, before operating the tool. Save these instructions and other documents supplied with this tool for future reference.

The charger has been designed for 230V and 240V only. Always check that the power supply corresponds to the voltage on the rating plate.

Note: The supply of 230V and 240V on Ozito chargers are interchangeable for Australia and New Zealand.



This tool's charger is double insulated; therefore no earth wire is required.

If the supply cord is damaged, it must be replaced by an electrician or a power tool repairer in order to avoid a hazard.

Note: Double insulation does not take the place of normal safety precautions when operating this tool. The insulation system is for added protection against injury resulting from a possible electrical insulation failure within the tool.

The power supply for this product's charger should be protected by a residual current device (rated at 30mA or less). A residual current device reduces the risk of electric shock.



GENERAL POWER TOOL SAFETY WARNINGS



WARNING! Read all safety warnings and all instructions. Failure to follow the warnings and instructions may result in electric shock, fire and/or serious injury.

Save all warnings and instructions for future reference. The term "power tool" in the warnings refers to your mains-operated (corded) power tool or battery-operated (cordless) power tool.

1. Work area safety

- Keep work area clean and well lit.** Cluttered or dark areas invite accidents.
- Do not operate power tools in explosive atmospheres, such as in the presence of flammable liquids, gases or dust.** Power tools create sparks which may ignite the dust or fumes.
- Keep children and bystanders away while operating a power tool.** Distractions can cause you to lose control.

2. Electrical safety

- Power tool plugs must match the outlet. Never modify the plug in any way. Do not use any adapter plugs with earthed (grounded) power tools.** Unmodified plugs and matching outlets will reduce risk of electric shock.
- Avoid body contact with earthed or grounded surfaces, such as pipes, radiators, ranges and refrigerators.** There is an increased risk of electric shock if your body is earthed or grounded.
- Do not expose power tools to rain or wet conditions.** Water entering a power tool will increase the risk of electric shock.
- Do not abuse the cord. Never use the cord for carrying, pulling or unplugging the power tool. Keep cord away from heat, oil, sharp edges or moving parts.** Damaged or entangled cords increase the risk of electric shock.
- When operating a power tool outdoors, use an extension cord suitable for outdoor use.** Use of a cord suitable for outdoor use reduces the risk of electric shock.
- If operating a power tool in a damp location is unavoidable, use a residual current device (RCD) protected supply.** Use of an RCD reduces the risk of electric shock.

3. Personal safety

- Stay alert, watch what you are doing and use common sense when operating a power tool. Do not use a power tool while you are tired or under the influence of drugs, alcohol or medication.** A moment of inattention while operating power tools may result in serious personal injury.
- Use personal protective equipment. Always wear eye protection.** Protective equipment such as dust mask, non-skid safety shoes, hard hat, or hearing protection used for appropriate conditions will reduce personal injuries.
- Prevent unintentional starting. Ensure the switch is in the off-position before connecting to power source and/or battery pack, picking up or carrying the tool.** Carrying power tools with your finger on the switch or energising power tools that have the switch on invites accidents.
- Remove any adjusting key or wrench before turning the power tool on.** A wrench or a key left attached to a rotating part of the power tool may result in personal injury.
- Do not overreach. Keep proper footing and balance at all times.** This enables better control of the

power tool in unexpected situations.

- Dress properly. Do not wear loose clothing or jewellery. Keep your hair, clothing and gloves away from moving parts.** Loose clothes, jewellery or long hair can be caught in moving parts.
 - If devices are provided for the connection of dust extraction and collection facilities, ensure these are connected and properly used.** Use of dust collection can reduce dust-related hazards.
- ## 4. Power tool use and care
- Do not force the power tool. Use the correct power tool for your application.** The correct power tool will do the job better and safer at the rate for which it was designed.
 - Do not use the power tool if the switch does not turn it on and off.** Any power tool that cannot be controlled with the switch is dangerous and must be repaired.
 - Disconnect the plug from the power source and/or the battery pack from the power tool before making any adjustments, changing accessories, or storing power tools.** Such preventive safety measures reduce the risk of starting the power tool accidentally.
 - Store idle power tools out of the reach of children and do not allow persons unfamiliar with the power tool or these instructions to operate the power tool.** Power tools are dangerous in the hands of untrained users.
 - Maintain power tools. Check for misalignment or binding of moving parts, breakage of parts and any other condition that may affect the power tool's operation. If damaged, have the power tool repaired before use.** Many accidents are caused by poorly maintained power tools.
 - Keep cutting tools sharp and clean.** Properly maintained cutting tools with sharp cutting edges are less likely to bind and are easier to control.
 - Use the power tool, accessories and tool bits etc. in accordance with these instructions, taking into account the working conditions and the work to be performed.** Use of the power tool for operations different from those intended could result in a hazardous situation.
- ## 5. Battery tool use and care
- Recharge only with the charger specified by the manufacturer.** A charger that is suitable for one type of battery pack may create a risk of fire when used with another battery pack.
 - Use power tools only with specifically designated battery packs.** Use of any other battery packs may create a risk of injury and fire.
 - When battery pack is not in use, keep it away from other metal objects, like paper clips, coins, keys, nails, screws or other small metal objects, that can make a connection from one terminal to another.** Shorting the battery terminals together may cause burns or a fire.
 - Under abusive conditions, liquid may be ejected from the battery; avoid contact. If contact accidentally occurs, flush with water. If liquid contacts eyes, additionally seek medical help.** Liquid ejected from the battery may cause irritation or burns.
- ## 6. Service
- Have your power tool serviced by a qualified repair person using only identical replacement parts.** This will ensure that the safety of the power tool is maintained.



POLE PRUNER SAFETY WARNINGS

This appliance is not intended for use by persons (including children) with reduced physical, sensory or mental capabilities, or lack of experience and knowledge, unless they have been given supervision or instruction concerning use of the appliance by a person responsible for their safety.

Young children should be supervised to ensure that they do not play with the appliance.

Recommendations for the use of a residual current device with a rated residual current of 30mA or less.

- Keep all parts of the body away from the saw chain when the chain saw is operating. Before you start the chain saw, make sure the saw chain is not contacting anything.** A moment of inattention while operating chain saws may cause entanglement of your clothing or body with the saw chain.
- Always hold the chain saw with your right hand on the rear handle and your left hand on the front handle.** Holding the chain saw with a reversed hand configuration increases the risk of personal injury and should never be done.
- Wear safety glasses and hearing protection. Further protective equipment for head, hands, legs and feet is recommended.** Adequate protective clothing will reduce personal injury by flying debris or accidental contact with the saw chain.
- Do not operate a chain saw in a tree.** Operation of a chain saw while up in a tree may result in personal injury.
- Always keep proper footing and operate the chain saw only when standing on fixed, secure and level surface.** Slippery or unstable surfaces such as ladders may cause a loss of balance or control of the chain saw.
- When cutting a limb that is under tension be alert for spring back.** When the tension in the wood fibres is released the spring loaded limb may strike the operator and/or throw the chain saw out of control.
- Use extreme caution when cutting brush and saplings.** The slender material may catch the saw chain and be whipped toward you or pull you off balance.
- Carry the chain saw by the front handle with the chain saw switched off and away from your body. When transporting or storing the chain saw always fit the guide bar cover. Proper handling of the chain saw will reduce the likelihood of accidental contact with the moving saw chain.**
- Follow instructions for lubricating, chain tensioning and changing accessories.** Improperly tensioned or lubricated chain may either break or increase the chance for kickback.
- Keep handles dry, clean, and free from oil and grease.** Greasy, oily handles are slippery causing loss of control.
- Cut wood only. Do not use chain saw for purposes not intended. For example: do not use chain saw for cutting plastic, masonry or non-wood building materials.** Use of the chain saw for operations different than intended could result in a hazardous

Kickback

Kickback may occur when the nose or tip of the guide bar touches an object, or when the wood closes in and pinches the saw chain in the cut.

Tip contact in some cases may cause a sudden reverse reaction, kicking the guide bar up and back towards the operator.

Pinching the saw chain along the top of the guide bar may push the guide bar rapidly back towards the operator.

Either of these reactions may cause you to lose control of the saw which could result in serious personal injury. Do not rely exclusively upon the safety devices built into your saw. As a chain saw user, you should take several steps to keep your cutting jobs free from accident or injury.

Kickback is the result of tool misuse and/or incorrect operating procedures or conditions and can be avoided by taking proper precautions as given below:

- Maintain a firm grip, with thumbs and fingers encircling the chain saw handles, with both hands on the saw and position your body and arm to allow you to resist kickback forces. Kickback forces can be controlled by the operator, if proper precautions are taken. Do not let go of the chain saw.
- Do not overreach and do not cut above shoulder height. This helps prevent unintended tip contact and enables better control of the chain saw in unexpected situations.
- Only use replacement bars and chains specified by the manufacturer. Incorrect replacement bars and chains may cause chain breakage and/or kickback.
- Follow the manufacturer's sharpening and maintenance instructions for the saw chain. Decreasing the depth gauge height can lead to increased kickback.

Push Back

Push back will occur if an attempt is made to saw with the top of the guide bar, if the chain touches against a rigid object and jams in the cut.

Pull Forward

If the bucking spikes are not set against the timber, the chain at the bottom of the guide bar will pull the saw forward; this can jam the chain in the timber.

To avoid this always have the bucking spikes set against the timber when performing a cut.



18V LITHIUM ION

CORDLESS POLE PRUNER

INSTRUCTION MANUAL



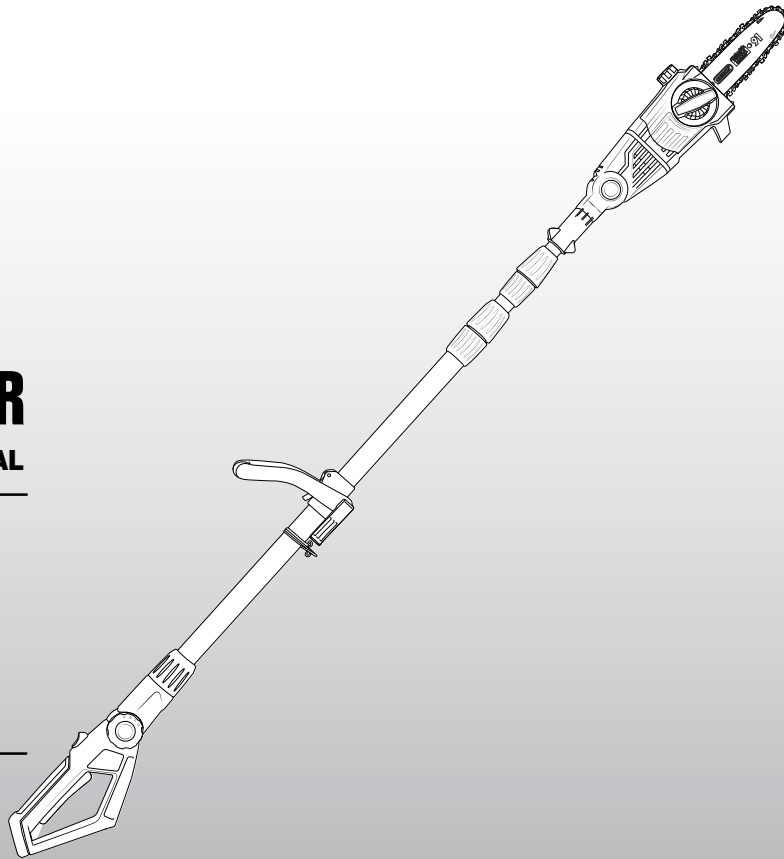

SPECIFICATIONS

| | |
|----------------------|--------------|
| Input: | 18V |
| Bar Length: | 200mm |
| Cutting Length Max.: | 170mm |
| Chain Speed: | 3.76m/s |
| Oil Tank Capacity: | 125ml |
| Length: | 1.83 - 2.77m |
| Weight: | 3.9kg |

ozito.com.au

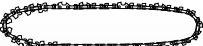

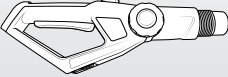
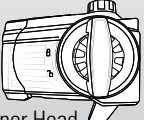
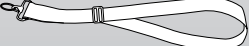
WHAT'S IN THE BOX

-  Pole
-  Chain
-  Guide Bar
-  Guide Bar Cover
-  Rear Handle
-  Pruner Head
-  Shoulder Strap
-  Auxiliary Handle

5 YEAR
REPLACEMENT WARRANTY*

PXCPPHTC-418

WARRANTY

IN ORDER TO MAKE A CLAIM UNDER THIS WARRANTY YOU MUST RETURN THE PRODUCT TO YOUR NEAREST BUNNINGS WAREHOUSE WITH YOUR BUNNINGS REGISTER RECEIPT. PRIOR TO RETURNING YOUR PRODUCT FOR WARRANTY PLEASE TELEPHONE OUR CUSTOMER SERVICE HELPLINE:

Australia 1800 069 486
New Zealand 0508 069 486

TO ENSURE A SPEEDY RESPONSE PLEASE HAVE THE MODEL NUMBER AND DATE OF PURCHASE AVAILABLE. A CUSTOMER SERVICE REPRESENTATIVE WILL TAKE YOUR CALL AND ANSWER ANY QUESTIONS YOU MAY HAVE RELATING TO THE WARRANTY POLICY OR PROCEDURE.

WARNING

The following actions will result in the warranty being void.

- If the tool has been operated on a supply voltage other than that specified on the tool.
- If the tool shows signs of damage or defects caused by or resulting from abuse, accidents or alterations.
- Failure to perform maintenance as set out within the instruction manual.
- If the tool is disassembled or tampered with in any way.

The benefits provided under this warranty are in addition to other rights and remedies which are available to you at law.

Our goods come with guarantees that cannot be excluded at law. You are entitled to a replacement or refund for a major failure and for compensation for any other reasonably foreseeable loss or damage. You are also entitled to have the goods repaired or replaced if the goods fail to be of acceptable quality and the failure does not amount to a major failure.

Generally you will be responsible for all costs associated with a claim under this warranty, however, where you have suffered any additional direct loss as a result of a defective product you may be able to claim such expenses by contacting our customer service helpline above.

5 YEAR REPLACEMENT WARRANTY

Your Product is guaranteed for a period of 60 months from the original date of purchase and is intended for DIY (Do It Yourself) use only. If a product is defective it will be replaced in accordance with the terms of this warranty. **Lithium Ion batteries and chargers are covered by a 36 month warranty** Warranty excludes consumable parts, for example: guide bar, chain and included accessories.

KNOW YOUR PRODUCT

CORDLESS POLE PRUNER

1. Chain
2. Guide Bar
3. Oil Cap
4. Side Cover
5. Pivoting Pruner Head Release
6. Telescopic Tube Lock
7. Main Tube
8. Auxiliary Handle
9. Shoulder Strap Holder
10. Assembly Nut
11. Pivoting Handle Release
12. Rear Handle
13. Chain Cover Lock
14. Chain Tension Adjustment Dial
15. Switch Lock
16. Auxiliary Handle Lever
17. Trigger Switch
18. Battery Seating
19. Mounting Attachment Lever

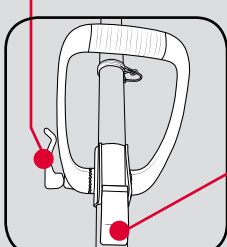
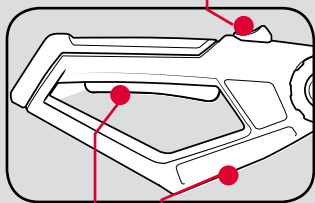
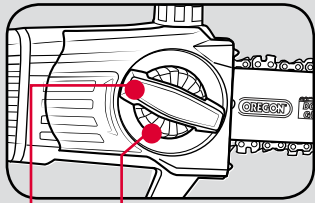
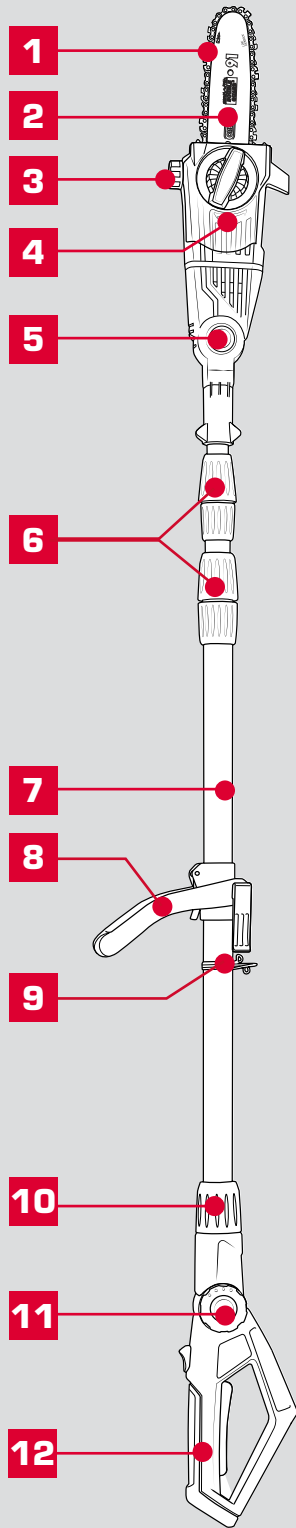

ONLINE MANUAL

Scan this QR Code with your mobile device to take you to the online manual.

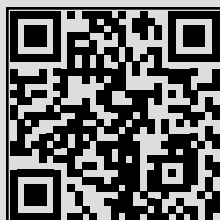

SETUP & PREPARATION

1. ASSEMBLY

CAUTION: ENSURE THE TOOL IS OFF & THE BATTERY REMOVED BEFORE PERFORMING ANY OF THE FOLLOWING OPERATIONS.

Fitting Rear Handle

1. Push the rear handle fully onto tube aligning the internal prongs.

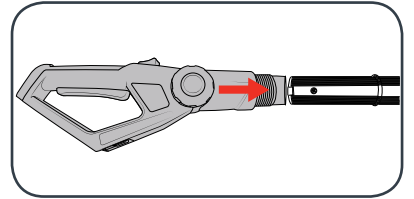

2. Screw tight with the assembly nut.

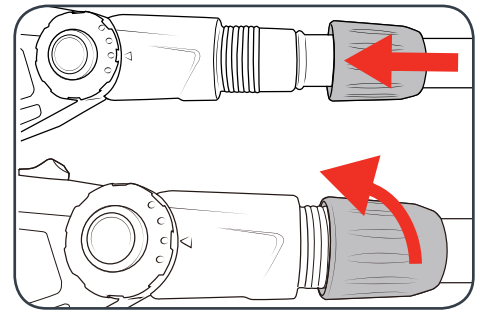

Fitting Auxiliary Handle

1. Place the Auxiliary Handle onto the mounting attachment.

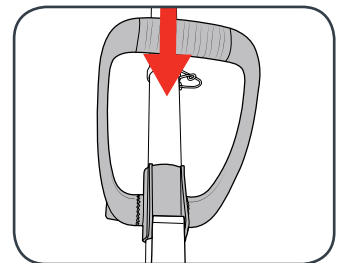

2. Pass the bolt through the auxiliary handle and screw the lever to the end of the bolt.

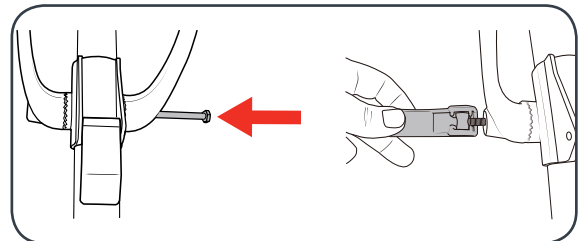

3. Select the most comfortable position and close the lever to lock the auxiliary handle in position.

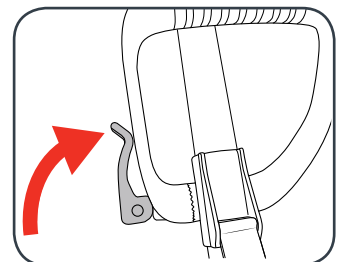

5 YEAR
REPLACEMENT WARRANTY*

Fitting Pruner Head

1. Align the pruner head and the motor head so the arrows on both coincide.

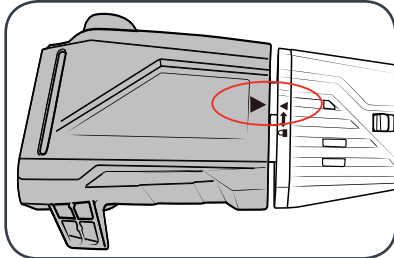

2. (a) Press the pruner head against the motor head. This will cause the lock button to be pushed to the right.
(b) Turn the pruner head clockwise. The pruner head will lock onto the motor head and is then secured in place.

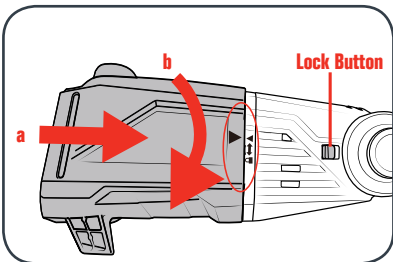

Note: The Lock Button will "CLICK" back to the left (original position) when the pruner head is correctly secured in place.

Fitting Guide Bar & Chain

1. Loosen the chain cover lock and remove the side cover.

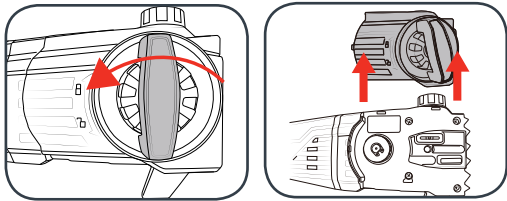

CAUTION: THE CHAIN HAS SHARP EDGES. FOR YOUR OWN SAFETY, PLEASE WEAR WORK GLOVES.

2. Place the chain in the groove of the guide bar as shown. Refer to the image printed on the guide bar that indicates the direction that the chain should face.

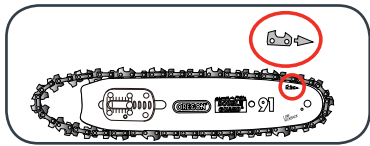

IMPORTANT: IF THE CHAIN IS INSTALLED BACKWARDS (CHAIN CUTTERS ARE FACING IN THE OPPOSITE DIRECTION OF ROTATION) THE POLE PRUNER WILL VIBRATE EXCESSIVELY AND NOT CUT.

3. Place onto the mount, ensuring that the chain sits around the chain sprocket.

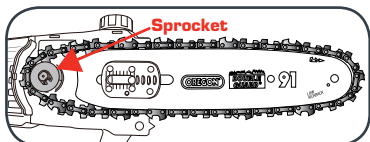

4. Re-mount and finger-tighten the side cover with the chain cover lock.

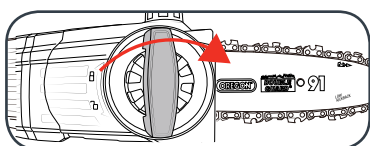

Note: Only tighten the chain cover locking knob securely once the chain tension has been adjusted (see: Tensioning the chain.)

2. TENSIONING THE CHAIN

CAUTION: THE CHAIN HAS SHARP EDGES. FOR YOUR OWN SAFETY, PLEASE WEAR WORK GLOVES.

1. Loosen the chain cover lock. Do not remove the side cover.

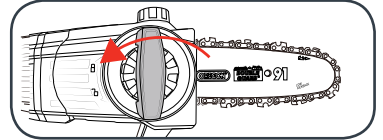

CAUTION: IF YOU TRY TO ROTATE THE CHAIN TENSIONING ADJUSTMENT DIAL WHILST THE CHAIN COVER LOCK IS TIGHT, IT WILL RESULT IN THE CHAIN NOT LOOSENING AND POSSIBLE DAMAGE TO THE MECHANISM.

2. Adjust the chain tension with the chain tensioning adjustment dial. Turning the dial CLOCKWISE increases the chain tension, turning it COUNTER-CLOCKWISE decreases the chain tension.

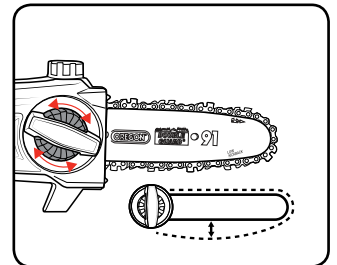

For the correct chain tension, firmly pull up on the chain at the middle of the top of the exposed guide bar. When the chain is pulled up to its highest point, the bottom tip of the links should only just stay in the track [middle of the guide bar]

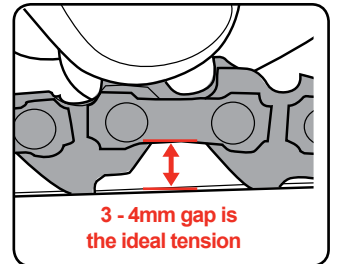

3. After the chain has been accurately tensioned, lock the guide bar in place with the chain cover locking knob.

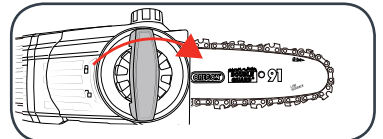

Note: Proper tension of the chain is extremely important and must be checked before starting, as well as during any cutting operation. Taking the time to make adjustments to the chain will result in improved cutting performance and prolonged chain life.

3. OIL

IMPORTANT: ONLY USE OIL THAT IS EXPRESSLY LABELLED "CHAIN BAR OIL".

1. Remove the chain bar oil cap.

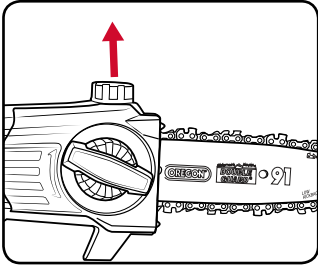

2. Fill the tank with chain bar oil. The capacity of the chain oil tank is 125ml. Do not over fill.

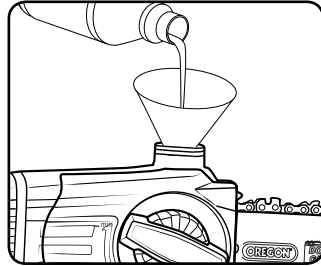

3. Refit cap and clean any oil spillage.

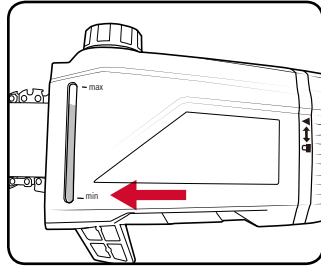

4. Always fill oil tank when the oil level is below the minimum mark on the oil level window.

WARNING! NEVER START WORK UNLESS THE CHAIN AND BAR ARE LUBRICATED

4. To check the lubricating system, switch on the pole pruner and hold it with the guide bar and chain above some light coloured paper such as newspaper. A steadily increasing stain caused by oil spray shows the lubricating system is working.

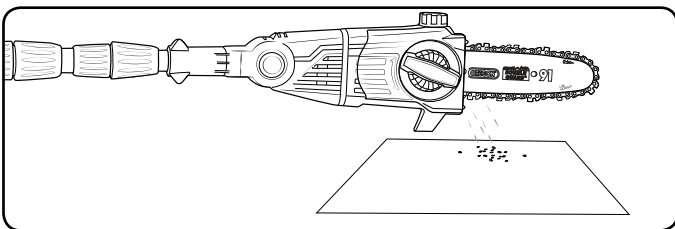

Note: Chain bar oil may leak if the tool is left for long periods. This is normal. If the tool is to be left unused for an extended time, drain the oil from the tool. Refill before use.

4. PREPARATION

Adjusting the telescope length

1. To unlock the telescopic tube lock, twist it in a clockwise direction while pointing the chain away from the user.

Note: The locking and unlocking directions are indicated on the locking collar.

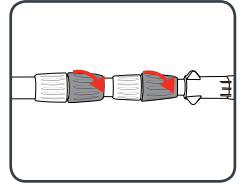

2. Pull out the telescopic tubes to suit the required working height.

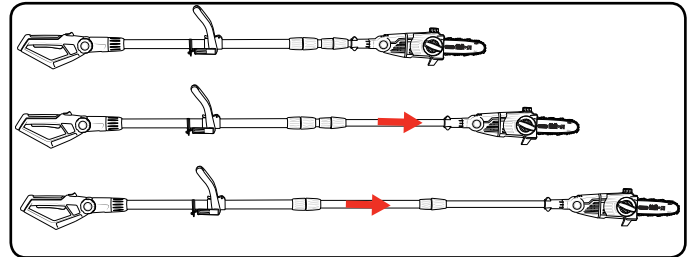

3. To lock in the desired position, twist the telescopic tube lock in a counter-clockwise direction.

Adjusting the Rear Handle

1. Press the two pivoting handle releases, one each side and adjust the angle of the handle up or down to any of 4 positions.

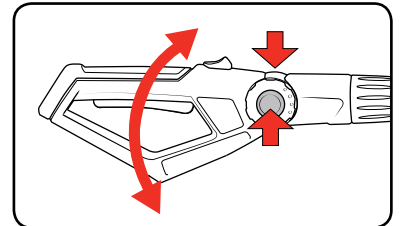

Adjusting the Auxiliary Handle

1. (a) Open the handle lever and set the required (b) tilt of the auxiliary handle, close to lock into position.
2. (a) Open the mounting bracket lever and (b) slide the auxiliary handle into the required position, close to lock into position.

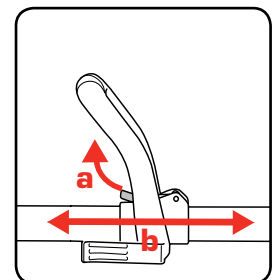
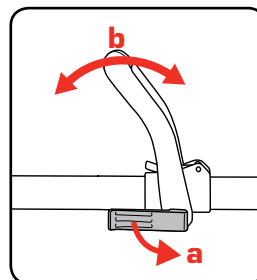

Attaching the Shoulder Strap

1. Fasten to the shoulder strap holder on the main tube.
2. Wear the shoulder strap so that it lies over the left shoulder.

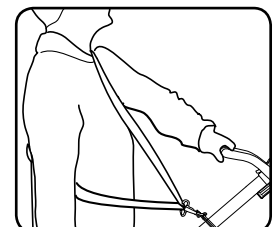
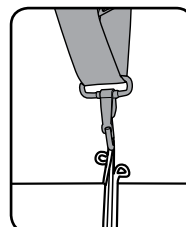

5. PRUNER HEAD

Adjusting the Pruner Head

• Pivoting the Pruner Head

1. Press the two pivoting head releases, one each side and adjust the angle of the pruner head up or down to any of 7 positions.

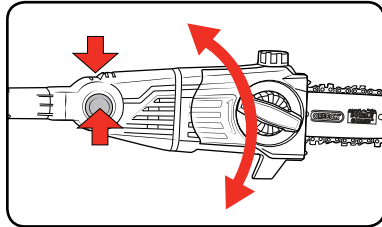

• Adjusting the Pruner Head 90°

1. Pull the lock button to the right then rotate the Pruner Head 90° clockwise

Note: Keep the pruner head pressed against the motor head when rotating.

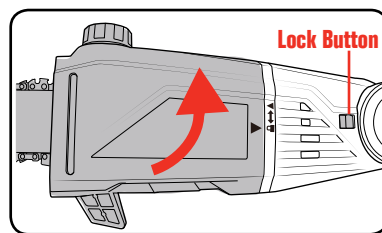

2. The pruner head will lock onto the motor head and is then secured in place.

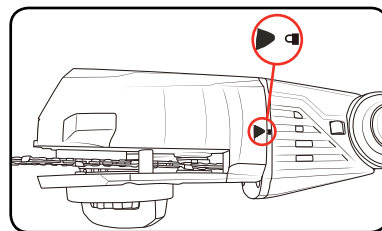

Note: The Lock Button will "CLICK" back to the left (original position) when the pruner head is correctly secured in place.

Removing the Pruner Head

1. (a) Pull and hold the Lock Button to the right.
(b) Turn the Pruner Head anti-clockwise so the arrows on the Motor Head and the Pruner Head coincide, allowing the Pruner Head to be removed.

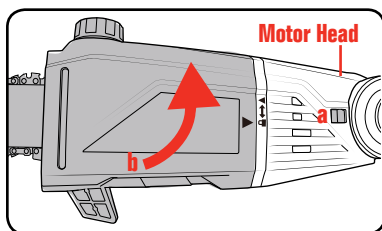

6. INSERTING & REMOVING THE BATTERY

Installing a Battery into the Pole Pruner

1. Align the ribs of the battery with the recess below the handle

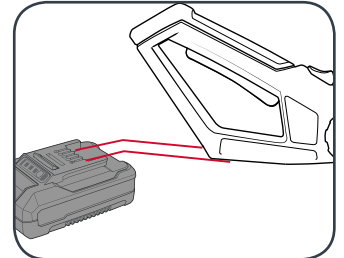

2. Slide the battery in so that it clicks into place.

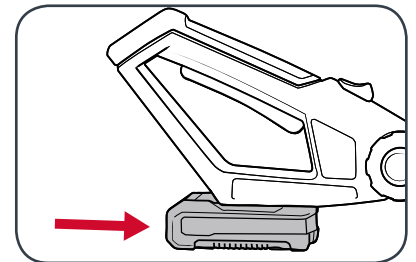

Removing a Battery from the Pole Pruner

1. Press and hold the battery release tab to release the battery.

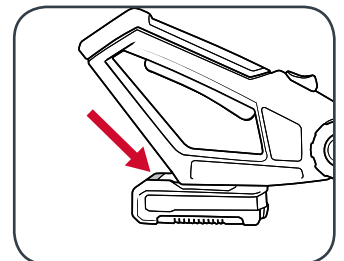

2. Slide the battery out.

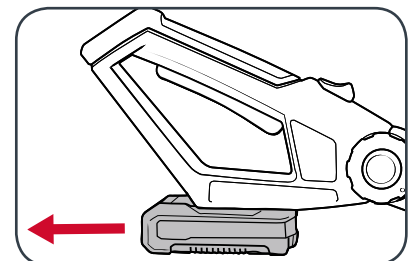

OPERATION

5. SWITCHING ON/OFF

Switching On

1. Hold the pole hedge trimmer firmly with both hands.

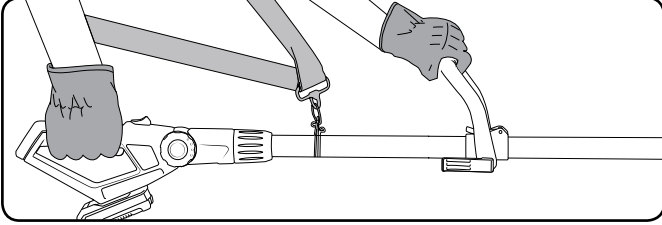

2. Slide the switch lock (a) to the front with your thumb and hold, then squeeze the trigger switch (b).
3. The blade will now be running ready to make a cut. Release the switch lock (a).

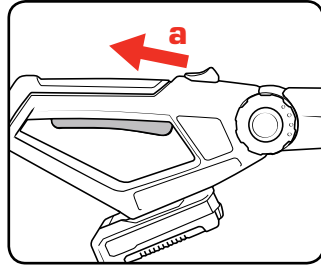
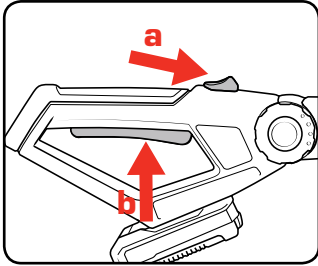

Switching Off

3. Release the trigger switch. The blade and motor will quickly stop.

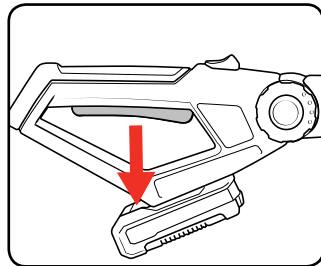

Trimming

- **Working position.** Maintain proper footing and balance and do not overreach. Wear safety goggles, non-slip footwear and rubber gloves when trimming. Hold the pole hedge trimmer firmly in both hands before turning the pole hedge trimmer on. Always hold the pole hedge trimmer with one hand on the rear handle and one hand on the auxiliary handle.

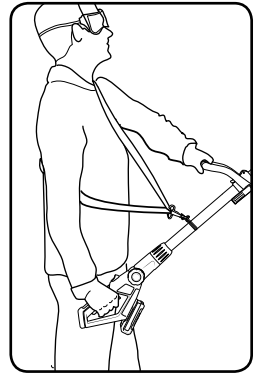

- **Trimming new growth.** Using a wide sweeping motion, feed the blade teeth through the twigs. A slight downward tilt of the blade, in the direction of motion gives the best cut.

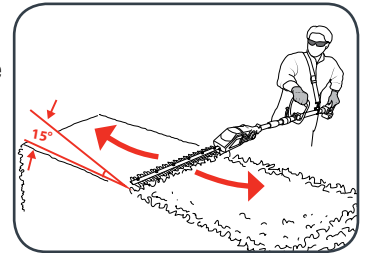

Note: Do not use the pole hedge trimmer for cutting stems greater than 12mm. Use the trimmer only for cutting normal shrubbery found around houses and buildings.

- **Level hedges.** To obtain exceptionally level hedges a piece of string can be stretched along the length of the hedge as a guide.
- **Side-trimming hedges.** Hold the pole hedge trimmer and begin at the bottom and sweep up.
- **Cutting sequence.** First cut both sides, starting at the bottom and work to the top: this prevents cuttings from falling into the area where you are still working.
- **Trimming the top.** Where the branches have grown extremely long, cut back the hedge in several stages.

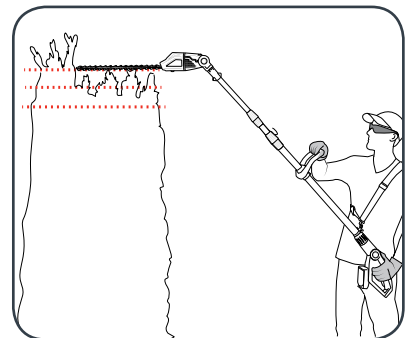

- **General information.** When older hedges are to be cut back a substantial amount, use pruning shears or some other device to trim thicker branches (greater than 12mm diameter) to the desired length before starting work with the pole hedge trimmer. Ensure the blades do not come into contact with any object made of hard material that could damage the blades, such as wire fencing or metal plant supports.

APPLICATIONS

WARNING! FAMILIARISE YOURSELF WITH SURROUNDING HAZARDS SUCH AS POWER LINES, PHONE LINES, METAL FENCES AND OTHER OBJECTS THAT COULD BE IN YOUR TRIMMING PATH, FAILURE TO DO SO COULD RESULT IN ELECTRICAL SHOCK, PERSONAL INJURY OR DAMAGE TO YOUR POLE HEDGE TRIMMER.

WARNING! NEVER USE THE POLE HEDGE TRIMMER WHEN STANDING ON A LADDER OR UNEVEN GROUND. DO NOT OVERREACH. ALWAYS USE BOTH HANDS TO HOLD THE POLE HEDGE TRIMMER.

CAUTION! ENSURE APPROPRIATE CARE IS TAKEN WHEN CUTTING ABOVE SHOULDER HEIGHT.

CAUTION! IF THE BLADES COME IN CONTACT WITH A HARD OBJECT, VISUALLY INSPECT THE BLADE FOR DAMAGE. IF THE BLADE IS DAMAGED, DO NOT CONTINUE TO OPERATE THE POLE HEDGE TRIMMER.

MAINTENANCE

WARNING: BEFORE CLEANING YOUR POLE HEDGE TRIMMER OR CARRYING OUT ANY MAINTENANCE PROCEDURE, ENSURE THE TOOL IS OFF & THE BATTERY REMOVED.

- When not in use, the Pole Hedge Trimmer should be stored in a dry, frost free location not within the reach of children.
- Keep ventilation slots of the Pole Hedge Trimmer clean at all times and prevent any foreign matter from entering.
- If the enclosure of the Pole Hedge Trimmer requires cleaning do not use solvents but a moist cloth only.
- There are no user serviceable parts in the Pole Hedge Trimmer; if a fault is suspected, please contact Ozito customer service.
- The blade rail should be cleaned and treated with light machine oil or spray lubricant (such as WD40, CRC 5.56 or RP7) after each use. When a job lasts for a longer period of time it is recommended that the blade rail also be treated with spray lubricant at regular intervals during operation.

TROUBLESHOOTING

Battery protection system

The tool is equipped with the battery protection system, which helps to ensure a long service life.

The output power automatically cuts off during operation when the tool and/or battery are placed under the following situations:

- When the tool is overloaded:**
If this occurs, release the trigger switch and remove causes of overload, then pull the switch trigger again to restart.
- When the remaining battery capacity becomes low:**
Recharge the battery pack.

Note: The battery protection system does not in any way damage the tool.

Note: The indicated capacity may be lower than the actual level during use or immediately after using the tool.

LED lights do not illuminate on charger

Check the charging adaptor is securely plugged into the wall outlet.

Check the battery is firmly connected to the charging cradle.

Check that the charging jack is securely connected to the charging cradle.

The battery has a short run time

Ensure the battery is properly charged. It will take 4-5 charging cycles before the battery reaches optimum charge and run time.

Sparking visible through the housing air vents

A small amount of sparking may be visible through the housing vents. This is normal and does not indicate a problem.

CARING FOR THE ENVIRONMENT



Power tools that are no longer usable should not be disposed of with household waste but in an environmentally friendly way. Please recycle where facilities exist. Check with your local council authority for recycling advice.



Recycling packaging reduces the need for landfill and raw materials. Reuse of recycled material decreases pollution in the environment. Please recycle packaging where facilities exist. Check with your local council authority for recycling advice.

DESCRIPTION OF SYMBOLS

| | | | |
|--------------------------|--|-----------|--|
| v | Volts | Hz | Hertz |
| dc/--- | Direct current | no | No load speed |
| /min⁻¹ | Revolutions or reciprocation per minute | | Double insulated |
| | Regulator compliance mark | | Transformer Energy Rating (MEPS) |
| | Read instruction manual | | Wear eye, ear and head protection |
| | Wear safety gloves | | Keep bystanders away |
| | Keep hands away from blade | | Warning |
| | Wear safety boots | | Sound pressure level |
| | Do not use in the rain or leave the pole hedge trimmer outdoors while raining. | | |
| | Maintain a minimum clearance of 10 m from current-carrying lines. Life-threatening danger from electric shock. | | |
| ac/~ | Alternating Current | W | Watts |
| mA | Milliamperes | Ah | Amp Hour |
| | Lithium Ion Battery | | Do not use or store battery in temperatures exceeding 50°C |
| | Recycle Battery | | Do not put in the rubbish |
| | Do not incinerate | | Do not get battery wet |
| | Indoor use only | | Thermal cut out protection |

BATTERY AND CHARGER SAFETY WARNINGS

THIS MANUAL CONTAINS IMPORTANT SAFETY AND OPERATING INSTRUCTIONS FOR YOUR BATTERY CHARGER.

- Before using the charger read all instructions and cautionary markings on the charger, battery pack and the product using the battery pack.
- This charger is not intended for any uses other than charging rechargeable batteries. Any other use may result in risk of fire, electric shock or electrocution.
- Do not place any object on top of the charger or place the charger on a soft surface that may result in excessive internal heat. Place the charger in a position away from any heat source.
- To reduce risk of damage to the electric plug and cord, pull by the plug rather than the cord when disconnecting the charger.
- Make sure the cord is located so that it will not be stepped on, tripped over, or otherwise subjected to damage or stress.
- An extension cord should not be used unless absolutely necessary. Use of an improper extension cord could result in the risk of fire, electric shock or electrocution.
- Do not operate the charger if it has received a sharp blow, been dropped or otherwise damaged in any way. Have it checked by an electrician or power tool repairer.
- Do not disassemble charger. Take it to an electrician or power tool repairer when service or repair is required. Incorrect reassembly may result in a risk of electric shock, electrocution or fire.
- To reduce risk of electric shock, unplug the charger from the outlet before attempting any cleaning. Removing the battery pack will not reduce this risk.
- Never attempt to connect 2 chargers together.
- DO NOT store or use the tool and battery pack in locations where the temperature may reach or exceed 40°C (such as inside sheds or metal buildings in summer).
- The charger is designed to operate on standard household electrical power (240 volts). Do not attempt to use it on any other voltage!
- The battery pack is not fully charged out of the carton. First read the safety instructions and then follow the charging notes and procedures.
- The longest life and best performance can be obtained if the battery pack is charged when the air temperature is between 18 - 24°C. Do not charge the battery pack in an air temperature below 10°C or above 40°C. This is important and will prevent damage to the battery pack.
- Do not incinerate the battery pack even if it is seriously damaged or is completely worn out. The battery can explode in a fire.
- Never attempt to open the battery pack for any reason. If the plastic housing of the battery pack breaks or cracks, immediately discontinue use and do not recharge.
- During charging, the battery must be placed in a well ventilated area.



ELECTRICAL SAFETY



WARNING! When using mains-powered tools, basic safety precautions, including the following, should always be followed to reduce risk of fire, electric shock, personal injury and material damage.

Read the whole manual carefully and make sure you know how to switch the tool off in an emergency, before operating the tool. Save these instructions and other documents supplied with this tool for future reference.

The charger has been designed for 230V and 240V only. Always check that the power supply corresponds to the voltage on the rating plate.

Note: The supply of 230V and 240V on Ozito chargers are interchangeable for Australia and New Zealand.



This tool's charger is double insulated; therefore no earth wire is required.

If the supply cord is damaged, it must be replaced by an electrician or a power tool repairer in order to avoid a hazard.

Note: Double insulation does not take the place of normal safety precautions when operating this tool. The insulation system is for added protection against injury resulting from a possible electrical insulation failure within the tool.

The power supply for this product's charger should be protected by a residual current device (rated at 30mA or less). A residual current device reduces the risk of electric shock.



GENERAL POWER TOOL SAFETY WARNINGS



WARNING! Read all safety warnings and all instructions. Failure to follow the warnings and instructions may result in electric shock, fire and/or serious injury.

Save all warnings and instructions for future reference. The term "power tool" in the warnings refers to your mains-operated (corded) power tool or battery-operated (cordless) power tool.

1. Work area safety

- Keep work area clean and well lit.** Cluttered or dark areas invite accidents.
- Do not operate power tools in explosive atmospheres, such as in the presence of flammable liquids, gases or dust.** Power tools create sparks which may ignite the dust or fumes.
- Keep children and bystanders away while operating a power tool.** Distractions can cause you to lose control.

2. Electrical safety

- Power tool plugs must match the outlet. Never modify the plug in any way. Do not use any adapter plugs with earthed (grounded) power tools.** Unmodified plugs and matching outlets will reduce risk of electric shock.
- Avoid body contact with earthed or grounded surfaces, such as pipes, radiators, ranges and refrigerators.** There is an increased risk of electric shock if your body is earthed or grounded.
- Do not expose power tools to rain or wet conditions.** Water entering a power tool will increase the risk of electric shock.
- Do not abuse the cord. Never use the cord for carrying, pulling or unplugging the power tool. Keep cord away from heat, oil, sharp edges or moving parts.** Damaged or entangled cords increase the risk of electric shock.
- When operating a power tool outdoors, use an extension cord suitable for outdoor use.** Use of a cord suitable for outdoor use reduces the risk of electric shock.
- If operating a power tool in a damp location is unavoidable, use a residual current device (RCD) protected supply.** Use of an RCD reduces the risk of electric shock.

3. Personal safety

- Stay alert, watch what you are doing and use common sense when operating a power tool. Do not use a power tool while you are tired or under the influence of drugs, alcohol or medication.** A moment of inattention while operating power tools may result in serious personal injury.
- Use personal protective equipment. Always wear eye protection.** Protective equipment such as dust mask, non-skid safety shoes, hard hat, or hearing protection used for appropriate conditions will reduce personal injuries.
- Prevent unintentional starting. Ensure the switch is in the off-position before connecting to power source and/or battery pack, picking up or carrying the tool.** Carrying power tools with your finger on the switch or energising power tools that have the switch on invites accidents.
- Remove any adjusting key or wrench before turning the power tool on.** A wrench or a key left attached to a rotating part of the power tool may result in personal injury.
- Do not overreach. Keep proper footing and balance at all times.** This enables better control of the power tool in unexpected situations.

- Dress properly. Do not wear loose clothing or jewellery. Keep your hair, clothing and gloves away from moving parts.** Loose clothes, jewellery or long hair can be caught in moving parts.

- If devices are provided for the connection of dust extraction and collection facilities, ensure these are connected and properly used.** Use of dust collection can reduce dust-related hazards.

4. Power tool use and care

- Do not force the power tool. Use the correct power tool for your application.** The correct power tool will do the job better and safer at the rate for which it was designed.
- Do not use the power tool if the switch does not turn it on and off.** Any power tool that cannot be controlled with the switch is dangerous and must be repaired.
- Disconnect the plug from the power source and/or the battery pack from the power tool before making any adjustments, changing accessories, or storing power tools.** Such preventive safety measures reduce the risk of starting the power tool accidentally.
- Store idle power tools out of the reach of children and do not allow persons unfamiliar with the power tool or these instructions to operate the power tool.** Power tools are dangerous in the hands of untrained users.
- Maintain power tools. Check for misalignment or binding of moving parts, breakage of parts and any other condition that may affect the power tool's operation. If damaged, have the power tool repaired before use.** Many accidents are caused by poorly maintained power tools.
- Keep cutting tools sharp and clean.** Properly maintained cutting tools with sharp cutting edges are less likely to bind and are easier to control.
- Use the power tool, accessories and tool bits etc. in accordance with these instructions, taking into account the working conditions and the work to be performed.** Use of the power tool for operations different from those intended could result in a hazardous situation.

5. Battery tool use and care

- Recharge only with the charger specified by the manufacturer.** A charger that is suitable for one type of battery pack may create a risk of fire when used with another battery pack.
- Use power tools only with specifically designated battery packs.** Use of any other battery packs may create a risk of injury and fire.
- When battery pack is not in use, keep it away from other metal objects, like paper clips, coins, keys, nails, screws or other small metal objects, that can make a connection from one terminal to another.** Shorting the battery terminals together may cause burns or a fire.
- Under abusive conditions, liquid may be ejected from the battery; avoid contact. If contact accidentally occurs, flush with water. If liquid contacts eyes, additionally seek medical help.** Liquid ejected from the battery may cause irritation or burns.

6. Service

- Have your power tool serviced by a qualified repair person using only identical replacement parts.** This will ensure that the safety of the power tool is maintained.



POLE HEDGE TRIMMER SAFETY WARNINGS

- Keep all parts of the body away from the cutter blade.** Do not remove cut material or hold material to be cut when blades are moving. Make sure the switch is off when clearing jammed material. A moment of inattention while operating the hedge trimmer may result in serious personal injury.
- Carry the hedge trimmer by the handle with the cutter blade stopped.** When transporting or storing the hedge trimmer always fit the blade cover. Proper handling of the hedge trimmer will reduce possible personal injury from the cutter blades.
- Hold the power tool by insulated gripping surfaces only, because the cutter blade may contact hidden wiring or its own cord.** Cutter blades contacting a "live" wire may make exposed metal parts of the power tool "live" and could give the operator an electric shock.
- Perform visual inspection on the hedge being trimmed.** Ensure that there are no wire fences or foreign objects that may come into contact with the Pole Hedge Trimmer during operation.
- Inspect and maintain the Pole Hedge Trimmer regularly.** Have the Pole Hedge Trimmer repaired by an authorized repairer.
 - Never allow children or people unfamiliar with these instructions to use the Pole Hedge Trimmer.
 - Avoid using the Pole Hedge Trimmer, while people, especially children or pets are nearby.
 - Use the Pole Hedge Trimmer only in daylight.
 - Never operate the Pole Hedge Trimmer with a damaged cutting blade.
 - Switch on the Pole Hedge Trimmer only when hands and feet are away from the cutting blades.
 - Use only manufacturer's recommended replacement parts and accessories.
 - Always disconnect the battery from the Pole Hedge Trimmer and put the blade cover on when leaving the Pole Hedge Trimmer unattended.

- Disconnect the battery from the Pole Hedge Trimmer before carrying out any maintenance or cleaning work.
- When not in use, store the Pole Hedge Trimmer out of the reach of children
- Face the cutting blades away from yourself, other people and animals while the power is connected to the Pole Hedge Trimmer (especially during operation).
- Use both handles and shoulder strap.
- Keep ventilation openings clear of debris. Keep handles dry, clean and free of oil and grease.
- Never reach underneath the Pole Hedge Trimmer cutting blades until it has completely stopped and the power has been disconnected.

This appliance is not intended for use by persons (including children) with reduced physical, sensory or mental capabilities, or lack of experience and knowledge, unless they have been given supervision or instruction concerning use of the appliance by a person responsible for their safety.

SPARE PARTS

Spare parts can be ordered from the Special Orders Desk at your local Bunnings Warehouse.

For further information, or any parts not listed here, visit www.ozito.com.au or contact Ozito Customer Service:

Australia 1800 069 486

New Zealand 0508 069 486

E-mail: enquires@ozito.com.au



18V LITHIUM ION

CORDLESS POLE HEDGE TRIMMER

INSTRUCTION MANUAL

SPECIFICATIONS

| | |
|------------------------|--------------|
| Input: | 18V |
| Cutting Length: | 400mm |
| Max. Cutting Capacity: | 12mm |
| No Load Speed: | 1,700/min |
| Length: | 2.10 – 3.04m |
| Battery: | 4.0Ah Li-ion |
| Charge Time: | 80min |
| Weight: | 4.28kg |

ozito.com.au



WHAT'S IN THE BOX



Hedge Trimmer Head

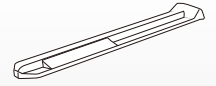

Blade Cover

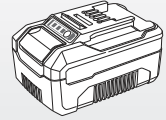

4.0Ah Battery

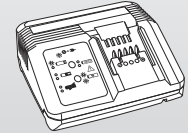

Fast Charger

5 YEAR
REPLACEMENT WARRANTY*

PXCPPHTC-418

WARRANTY

IN ORDER TO MAKE A CLAIM UNDER THIS WARRANTY YOU MUST RETURN THE PRODUCT TO YOUR NEAREST BUNNINGS WAREHOUSE WITH YOUR BUNNINGS REGISTER RECEIPT. PRIOR TO RETURNING YOUR PRODUCT FOR WARRANTY PLEASE TELEPHONE OUR CUSTOMER SERVICE HELPLINE:

Australia 1800 069 486
New Zealand 0508 069 486

TO ENSURE A SPEEDY RESPONSE PLEASE HAVE THE MODEL NUMBER AND DATE OF PURCHASE AVAILABLE. A CUSTOMER SERVICE REPRESENTATIVE WILL TAKE YOUR CALL AND ANSWER ANY QUESTIONS YOU MAY HAVE RELATING TO THE WARRANTY POLICY OR PROCEDURE.

WARNING

The following actions will result in the warranty being void.

- If the tool has been operated on a supply voltage other than that specified on the tool.
- If the tool shows signs of damage or defects caused by or resulting from abuse, accidents or alterations.
- Failure to perform maintenance as set out within the instruction manual.
- If the tool is disassembled or tampered with in any way.

The benefits provided under this warranty are in addition to other rights and remedies which are available to you at law.

Our goods come with guarantees that cannot be excluded at law. You are entitled to a replacement or refund for a major failure and for compensation for any other reasonably foreseeable loss or damage. You are also entitled to have the goods repaired or replaced if the goods fail to be of acceptable quality and the failure does not amount to a major failure.

Generally you will be responsible for all costs associated with a claim under this warranty, however, where you have suffered any additional direct loss as a result of a defective product you may be able to claim such expenses by contacting our customer service helpline above.

5 YEAR REPLACEMENT WARRANTY

Your Product is guaranteed for a period of 60 months from the original date of purchase and is intended for DIY (Do It Yourself) use only. If a product is defective it will be replaced in accordance with the terms of this warranty. **Lithium Ion batteries and chargers are covered by a 36 month warranty** Warranty excludes consumable parts, for example: blade and included accessories.

KNOW YOUR PRODUCT

CORDLESS POLE HEDGE TRIMMER

1. Blade
2. Trimmer Head

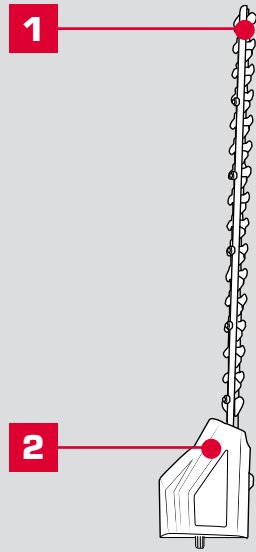

BATTERY & CHARGER

3. Battery Charge LED's
4. Battery Charge Indicator Bottom
5. Charger LED's
6. Charger

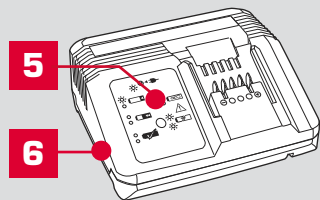
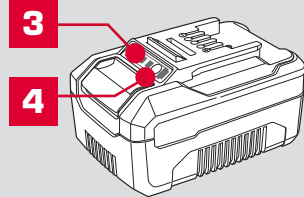

ONLINE MANUAL

Scan this QR Code with your mobile device to take you to the online manual.



SETUP & PREPARATION

1. ASSEMBLY

CAUTION: ENSURE THE TOOL IS OFF & THE BATTERY REMOVED BEFORE PERFORMING ANY OF THE FOLLOWING OPERATIONS.

Fitting Rear Handle

1. Push the rear handle fully onto tube aligning the internal prongs.

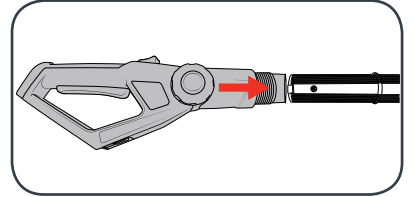

2. Screw tight with the assembly nut.

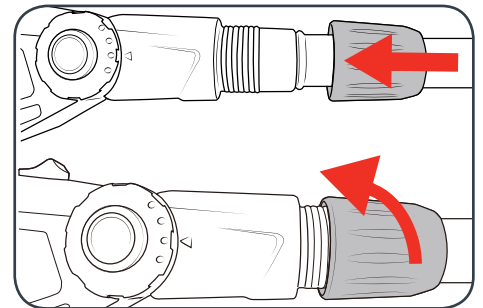

Fitting Auxiliary Handle

1. Place the Auxiliary Handle onto the mounting attachment.

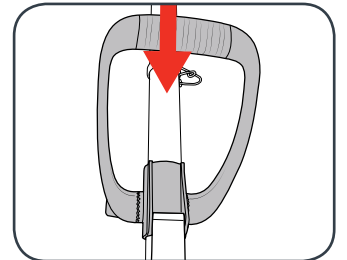

2. Pass the bolt through the auxiliary handle and screw the lever to the end of the bolt.

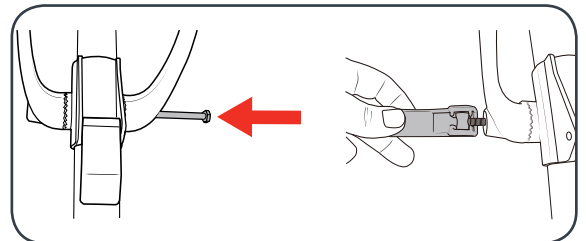

3. Select the most comfortable position and close the lever to lock the auxiliary handle in position.

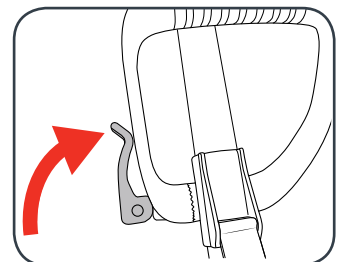

5 YEAR
REPLACEMENT WARRANTY*

Fitting Trimmer Head

CAUTION: THE BLADE HAS SHARP EDGES. FOR YOUR OWN SAFETY, PLEASE WEAR WORK GLOVES.

1. Align the Trimmer head and the motor head so the arrows on both coincide.

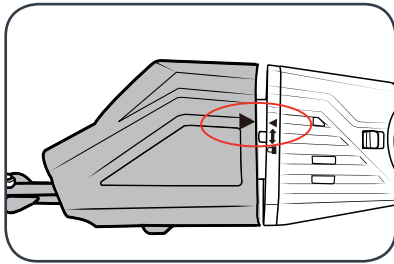

2. (a) Press the trimmer head against the motor head. This will cause the lock button to be pushed to the right.
(b) Turn the trimmer head clockwise. The trimmer head will lock onto the motor head and is then secured in place.

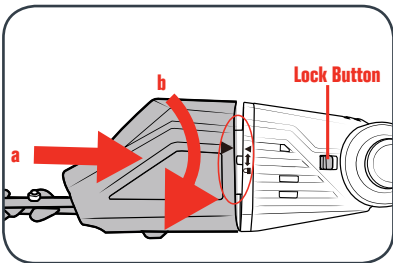

Note: The Lock Button will “CLICK” back to the left (original position) when the trimmer head is correctly secured in place.

Removing Trimmer Head

1. (a) Pull and hold the Lock Button to the right.
(b) Turn the Trimmer Head anti-clockwise so the arrows on the Motor Head and the Trimmer Head coincide, allowing the Trimmer Head to be removed.

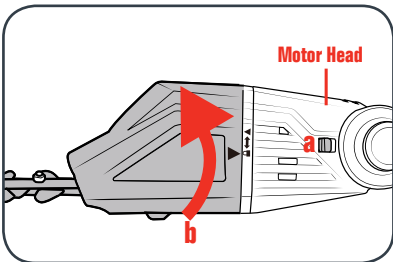

2. BATTERY & CHARGING



CAUTION: THE CHARGER FOR THIS PRODUCT SHOULD BE PROTECTED BY A RESIDUAL CURRENT DEVICE (RATED AT 30mA OR LESS).

The purchased battery will be shipped in a low charge condition, and requires charging prior to use. Allow several cycles of charging and discharging (through use of the tool) for the battery to reach its optimum performance / runtime.

Charging your lithium ion battery - Fast Charger

1. Connect the charger into a mains power outlet.

2. The charger LED will flash green showing power is being supplied to the charger.

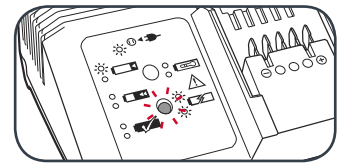

3. With the charger sitting on a flat surface, align the raised ribs on the battery with the recess in the charger and slide onto the charger ensuring a firm connection.

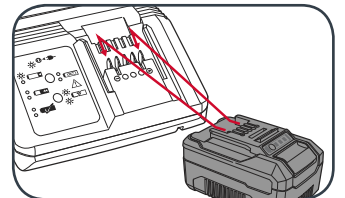

4. The charger LED will illuminate red signifying that the battery is charging.

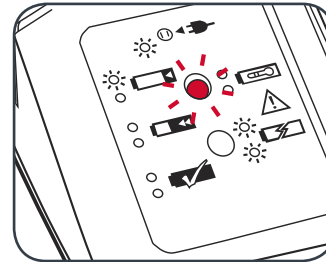

5. The charger LED will illuminate green once the battery is fully charged.

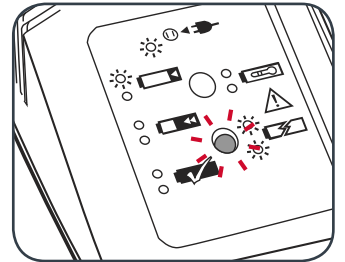

Charger LED Indicator

| LED Indicator | Situation |
|---------------------|--|
| GREEN (Flashing) | Stand By (no battery pack is inserted) |
| RED (Flashing) | Battery is charging (low charge) |
| RED (Illuminated) | Battery is charging (mid charge) |
| GREEN (Illuminated) | Battery is fully charged |
| BOTH (Illuminated) | Battery pack is too hot or too cold (charging will begin automatically when battery reaches correct charging temperature). |
| BOTH (Flashing) | Defective battery. Never charge a defective battery pack! Remove battery pack from charger. |

Battery Charge Indicator

The purchased battery is equipped with a battery charge indicator to show the state of the battery charge.

Press the charge indicator button and look to see which LED lights.

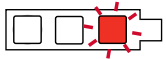
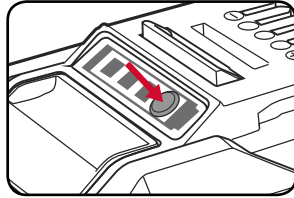

Battery requires immediate charging

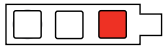

Low state of charge, requires charging soon.

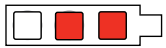

Mid state of charge

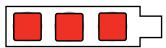

Full state of charge.

Note: The battery needs to be removed from the tool to check the state of charge.

3. PREPARATION

Adjusting the telescope length

1. To unlock the telescopic tube lock, twist it in a clockwise direction while pointing the trimmer blade away from the user.

Note: The locking and unlocking directions are indicated on the locking collar.

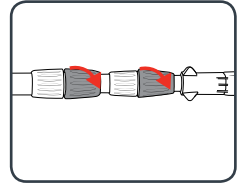
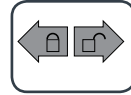

2. Pull out the telescopic tubes to suit the required working height.

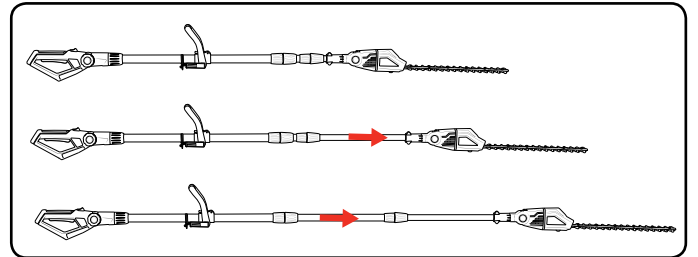

3. To lock in the desired position, twist the telescopic tube lock in a counter-clockwise direction.

Adjusting the Rear Handle

1. Press the two pivoting handle releases, one each side and adjust the angle of the handle up or down to any of 4 positions.

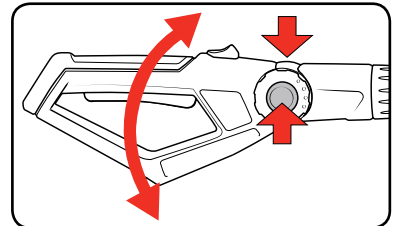

Adjusting the Additional Handle

1. (a) Open the handle lever and set the required (b) tilt of the additional handle, close to lock into position.
2. (a) Open the mounting bracket lever and (b) slide the additional handle into the required position, close to lock into position.

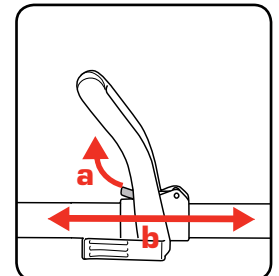
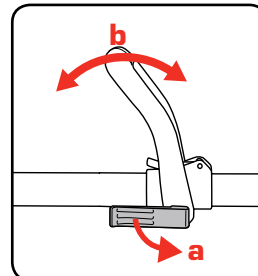

Pivoting the Trimmer Head

1. Press the two pivoting head releases, one each side and adjust the angle of the trimmer head up or down to any of 7 positions.

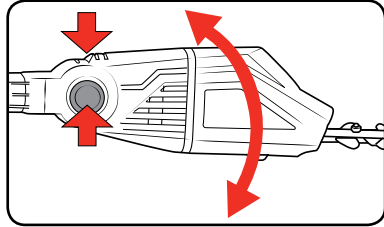

Attaching the Shoulder Strap

1. Fasten to the shoulder strap holder on the main tube.

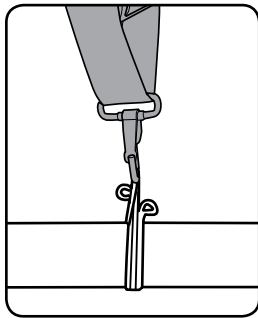

2. Wear the shoulder strap so that it lies over the left shoulder.

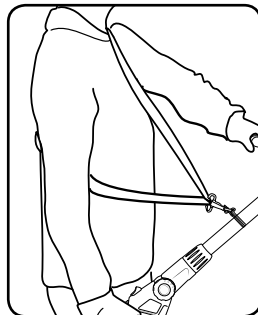

4. INSERTING & REMOVING THE BATTERY

Installing a Battery into the Pole Trimmer

1. Align the ribs of the battery with the recess below the handle.

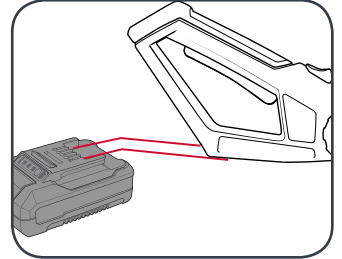

2. Slide the battery in so that it clicks into place.

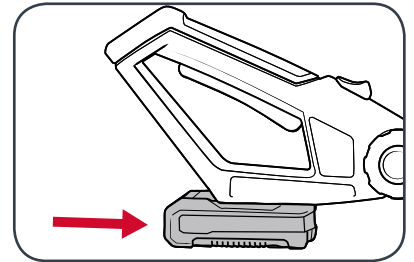

Removing a Battery from the Pole Trimmer

1. Press and hold the battery release tab to release the battery.

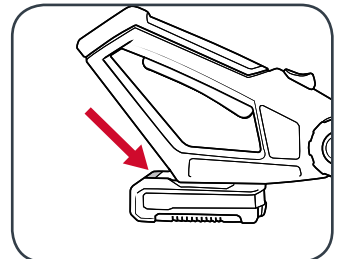

2. Slide the battery out.

