

# bellessi

## Splashbacks for Kitchen, Bathroom & Laundry



**SPECIAL  
ORDERS**



Available at  
**BUNNINGS**  
warehouse

**Take This Brochure** to the Special Orders Desk to place an order



# What is Bellessi?

The new, environmentally friendly way to add colour, functionality and durability to your home. It is perfect for use in kitchens, bathrooms, laundries, or virtually any vertical surface – Bellessi adds colour for life! It's light weight, cost effective, easy to cut to size and install on site.

Bellessi is a highly engineered polymer enhanced with colour. It is 50% lighter than glass and 25 times more impact resistant. Bellessi is the logical alternative to glass in your home as it won't shatter, crack or chip when hit with force and is on average 40% cheaper to install.

On average Bellessi can reduce installation time by more than 4 weeks over glass splashbacks as they can be cut on site and installed by almost anyone. Best of all, it lets your colourful ideas shine through.



## Can I use Bellessi behind cooktops?

### Electric Cooktops

You can install your 6mm thick Bellessi splashback directly behind any induction, ceramic or electric cooktop. (Please see *Heat Tolerance* section for warranty information)

### Gas Cooktops

When installation is behind a gas cooktop you must use a non combustible material such as our unique colour matched glass panels the width of your cooktop.

At Bellessi we've made things easy for installing splashbacks behind gas cooktops. Simply order one of our colour matched glass panels and your colour will flow almost seamlessly throughout your kitchen.

## Bathrooms, Kitchens & Laundries

Enhanced with colour, Bellessi splashbacks deliver a beautiful high gloss finish that is extremely DIY friendly to install.

In fact your Bellessi splashback can be installed onto basically any indoor vertical surface – with only standard tools required.



# Ordering checklist



1. Choose your colour or design \_\_\_\_\_
2. Confirm what sheet sizes and thickness will meet your requirements \_\_\_\_\_
3. Do you need a glass filler panel for Gas cooktop \_\_\_\_\_
4. Fill in all the details on your order form \_\_\_\_\_
5. Hand to Bunnings special order team member \_\_\_\_\_

## Installation

### Induction/Electric/Ceramic Cooktops

Bellessi can be used directly behind induction, electric and ceramic cooktops reducing time and hassles associated with colour back glass. Cooktops must be covered with cookware to avoid damage.

### Gas Cooktops

Bellessi can provide the option of a 200mm or 650mm high colour matched glass panel to suit 600mm or 900 mm wide cooktops which can be ordered through your Bunnings special order department.

\*200mm glass panel not available in Motiv range

### DIY Tools Required

- Drill
- Circular Saw
- Electric Plane
- Jigsaw
- Level
- Tape Measure
- Neutral Cure Silicone
- Double Sided VHB Tape
- Marking Pen
- Drill Bits
- Hole Saws
- Ruler
- Square
- Clamps

Support Bellessi panel back on plywood or MDF sheet or solid work top when cutting

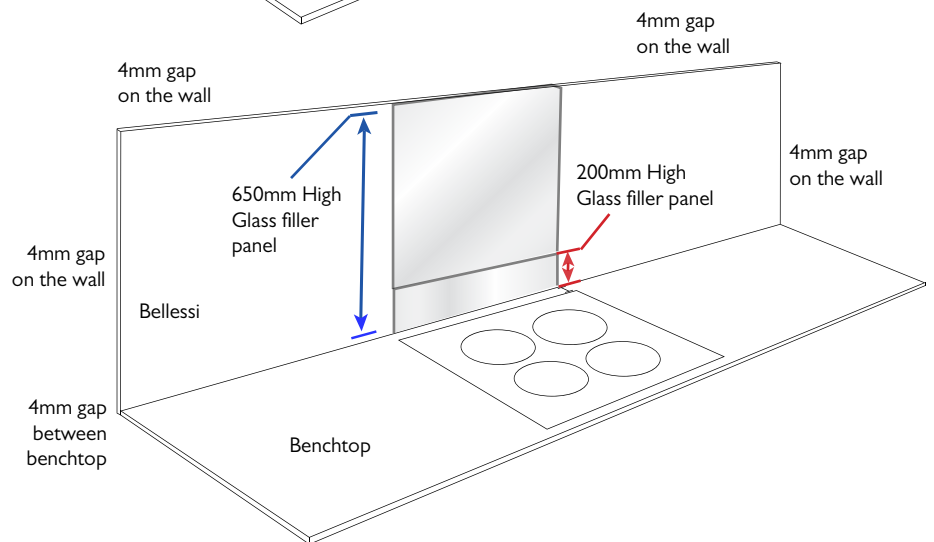
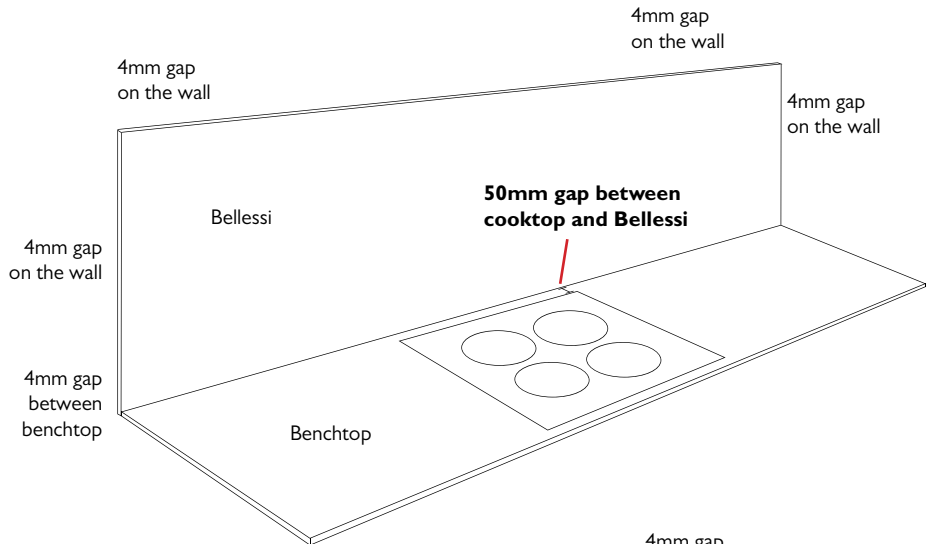
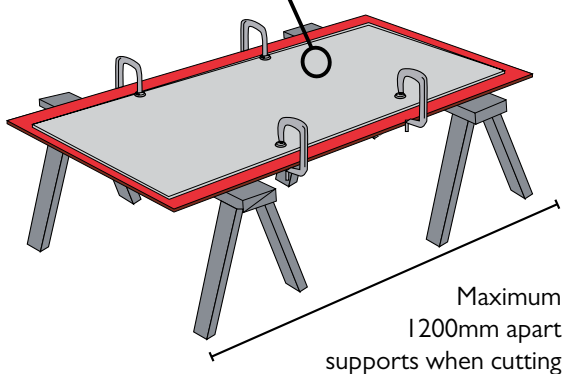

### Heat Tolerance

Do not leave your hot plate uncovered. An exposed cooktop emits far greater radiant heat than when covered and this can damage your splashback.

Bellessi is only covered under warranty against normal wear and tear.

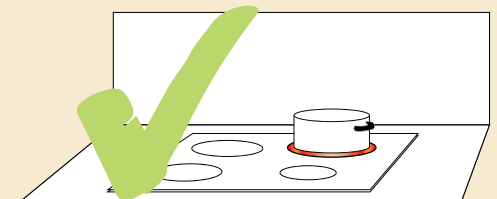
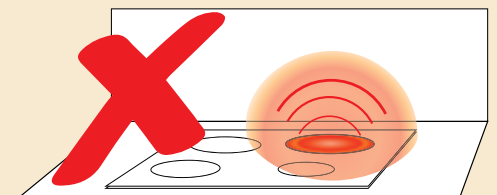

# 20 Vibrant Colours

\* Metallic



## Custom Colours

Ask your Bunnings team member how we can produce any panel in almost any colour.

We can produce any non-metallic paint colour stocked by Bunnings, giving you the option to further personalise your purchase of Bellessi products.

Special Order colours can simply be ordered by providing the relevant information on the attached order form in this brochure.

Note - Special Order colours can vary slightly from the original and from each batch. At times they can be difficult to match due to the age of the original product and lighting effect in the original location. In particular when using the glass colour matched panel system, slight differences can occur due to the nature of glass composition. Everything possible will be done to deliver the best match however due to the above factors a perfect match cannot always be guaranteed every time.

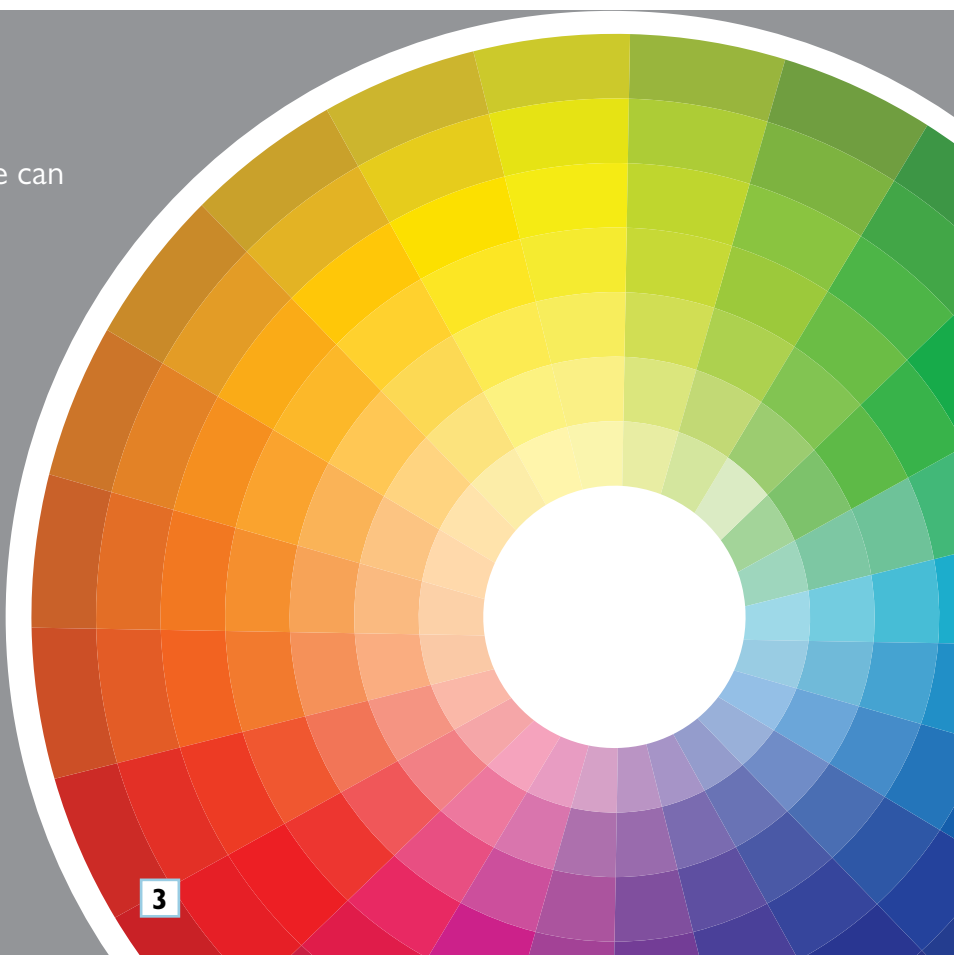

# bellessi motiv

Bellessi Motiv is a revolutionary new way to bring life to your kitchen, bathroom, shower area or entertaining space. It is proudly manufactured in Australia using an innovative, unique, environmentally friendly process.

With the same quality and features of our standard Bellessi range, Bellessi Motiv will offer a modern and vibrant look without the costly price tag of similar products that are available.

We offer many vibrant designs giving you the option to coordinate with just about any decor. Bellessi Motiv will be the envy of your friends making any space a feature of your home.

Bellessi Motiv is an investment in your home not just an investment in a great product.



Bellessi Motiv can also be installed behind any electric, induction or ceramic cooktop. Like the standard Bellessi range, you can use a colour matched glass panel behind gas cooktops. By using the order form attached and measuring your space correctly, your chosen design will flow almost seamlessly through the join with the glass filler panel.

## Bellessi Motiv Panel Range

### 6mm Thickness

725mm x 2440mm  
(Perfect for Splashbacks)

## Bellessi Motiv Glass Filler Panel Range

### 6mm Thickness

650mm x 600mm  
650mm x 900mm

Everything possible will be done to deliver the best match however due to the nature of paint a perfect match cannot always be guaranteed every time.



# 40 Eye Catching Designs

**bellessi**  
motiv



Blue Storm



Dust Storm



Beach Circles



Beach Dream



Morning Dew



Life's a Blur

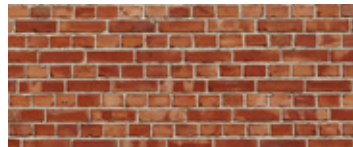

Red Wall



White Wall



Dandelion



Blue Horizon



Green Horizon



Green Grass

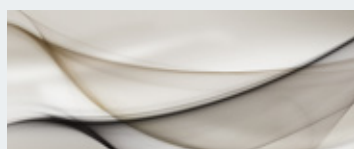

Latte Steam

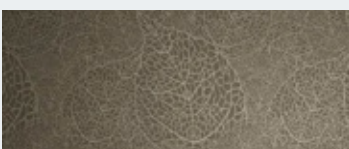

Fossil



Black Marble



White Marble



Grey Marble



Granite Grey

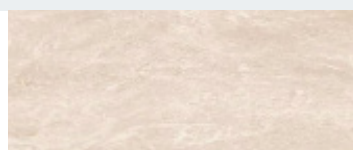

Sandstone



Sandy Desert

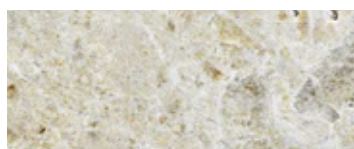

Grey Gravel

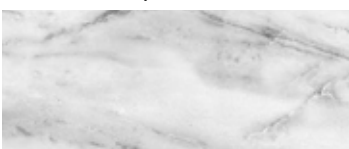

Smoke Marble



Grecian Marble

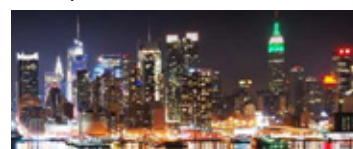

Manhattan Night



Skyline



Herringbone



Blue Drops



Purple Drops



White Lady



Manhattan Blues



Turbulent

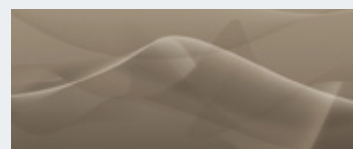

Desert



Winter Forest

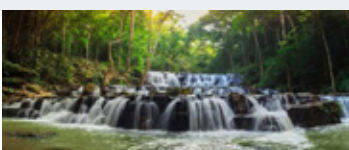

Cascades



Allsorts Yellow



Allsorts Blue



Allsorts Green

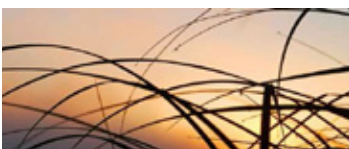

Sunset Strands



Venice



Whitewash Boards

Everything possible will be done to deliver the best match however due to the nature of paint a perfect match cannot always be guaranteed every time.

## Bellessi Polymer Panel Range

### 4mm Thickness

900mm x 2440mm

Ideal for Island back panels

920mm x 2000mm

1220mm x 2000mm

1220mm x 2440mm

1220mm x 3050mm

Ideal for Island back panels

145mm x 2440mm

Ideal for Kickboards

### 6mm Thickness

725mm x 1200mm

725mm x 2440mm

(Perfect for Splashbacks)

725mm x 3050mm

920mm x 2000mm

1220mm x 2000mm

1220mm x 2440mm

1220mm x 3050mm

145mm x 2440mm

Ideal for Kickboards

## Bellessi Glass Filler Panel Range

### 6mm Thickness

200mm x 600mm

200mm x 900mm

650mm x 600mm

650mm x 900mm

For use behind  
gas cooktops

When combining your Bellessi polymer panels with our unique colour matched glass panel system for use behind gas cooktop, you will have the complete DIY splashback solution which meets Australian standards.

## Key Features of the Complete Bellessi Range

- 10 year indoor U.V. warranty
- Easy to clean and maintain – soap and mould won't build up
- Beautiful high gloss finish for an eye catching result
- Perfect for use in kitchens, bathrooms and laundries
- Colour matched glass panels available for use behind gas cooktops
- Special order colours available – speak to your Bunnings team member
- Extremely durable – abrasion resistant
- Sanitary grade polymer
- 25 times more impact resistant than glass
- 50% lighter than glass – much quicker installation time
- All Bellessi polymer panels can be cut, drilled, planed, polished on site – the perfect DIY splashback
- Scratches can simply be polished out
- No grout lines – unlike tiles – making it easier to clean

Everything possible will be done to deliver the best match however due to the nature of paint a perfect match cannot always be guaranteed every time. Lighter colours can appear darker on glass panels due to the iron content of the glass.



## Where can I use it?

- Kitchen splashbacks
- Kickboards
- Island back panels
- Cupboard doors
- Showers
- Bathrooms
- Internal feature walls





# Bellessi Custom Range Order Form

CUSTOMER NAME \_\_\_\_\_ PURCHASE ORDER NUMBER \_\_\_\_\_

CUSTOMER CONTACT NUMBER \_\_\_\_\_ BUNNINGS STORE \_\_\_\_\_

DATE OF ORDER \_\_\_\_\_

Please specify the Bellessi size and colour choice by indicating the Item number, the Bellessi colour or the Bunnings paint code and the quantity you require.

I/N	Bellessi Colour or Paint Code	Dimensions	QTY	I/N	Bellessi Colour or Paint Code	Dimensions	QTY
		Bellessi 145 X 2440 4mm Polymer				Bellessi 920 X 2000 6mm Polymer	
		Bellessi 920 X 2000 4mm Polymer				Bellessi 1220 X 2000 6mm Polymer	
		Bellessi 900 X 2440 4mm Polymer				Bellessi 1220 X 2440 6mm Polymer	
		Bellessi 1220 X 2000 4mm Polymer				Bellessi 1220 X 3050 6mm Polymer	
		Bellessi 1220 X 2440 4mm Polymer		<b>Glass Panels Short</b>			
		Bellessi 1220 X 3050 4mm Polymer				Bellessi 200 x 600 x 6mm Glass	
		Bellessi 145 X 2440 6mm Polymer				Bellessi 200 x 900 x 6mm Glass	
		Bellessi 725 X 1200 6mm Polymer		<b>Glass Panels Tall</b>			
		Bellessi 725 X 2440 6mm Polymer				Bellessi 650 x 600 x 6mm Glass	
		Bellessi 725 X 3050 6mm Polymer				Bellessi 650 x 900 x 6mm Glass	

Note: While every effort is made to achieve the best colour match due to the composition of glass the coloured glass filler panels can vary up to 10% in difference from polymer panel colour.

## bellessi motiv

Please specify the Bellessi Motiv size, design choice and position of your cooktop if a glass panel is required.

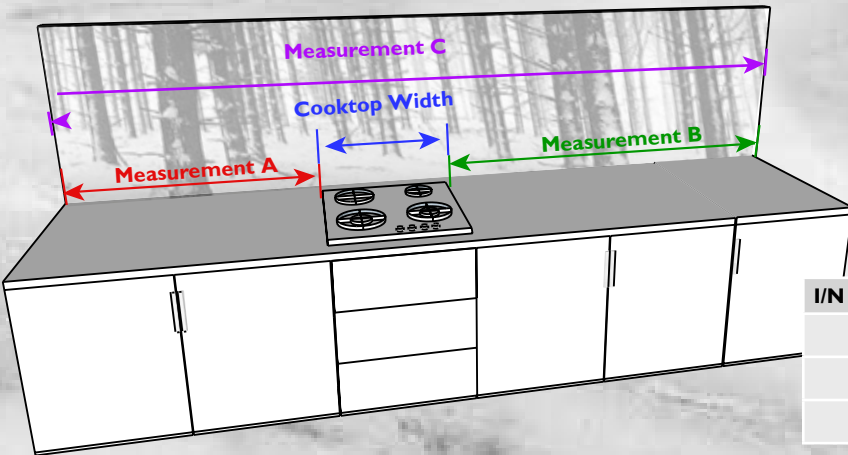

Measurement A  mm

Measurement B  mm

Measurement C  mm

Cooktop Width  
 600mm  900mm

Note: Bellessi Motiv Images are designed to suit an overall length of 2440mm. A section from your 2440mm Polymer splashback the width of your cooktop will be discarded to allow for the glass insert where required.

I/N	Motiv Design	Dimensions	QTY
		725mm H x 2440mm W x 6mm T	
		650mm H x 600mm W x 6mm T	
		650mm H x 900mm W x 6mm T	

Note: 200mm glass in-fill panels not available with Motive range.

Please note: All measurements, dimensions and/or colour details provided are the sole responsibility of the customer providing them. Bellessi holds no responsibility for mistakes, incorrect measurements or information supplied and will only manufacture our products to the information provided on this form. Special order colours can vary slightly from the original and from each batch. At times they can be difficult to match due to the age of original product and lighting effect in the original location. In particular when using the glass colour matched panel system slight differences can occur due to the nature of glass composition. Everything possible will be done to deliver the best match, however due to the above factors a perfect match cannot always be guaranteed every time.

T: 1800 45 47 44 E: [orders@composite.com.au](mailto:orders@composite.com.au) W: [www.bellessi.com.au](http://www.bellessi.com.au)

**More Choice**  
From Special Orders



Order through the  
**SPECIAL ORDERS** Desk

**BUNNINGS**  
warehouse