



18V LITHIUM ION

# CORDLESS WET & DRY VACUUM/ INFLATOR

## INSTRUCTION MANUAL

### SPECIFICATIONS

Input:	18V
Max. Suction Power:	80mbar
Inlet Air Flow:	20L/s
Container Capacity:	10L
Hose Length:	0.66-2m
Hose Diameter:	Ø35mm
Weight:	3.95kg

ozito.com.au

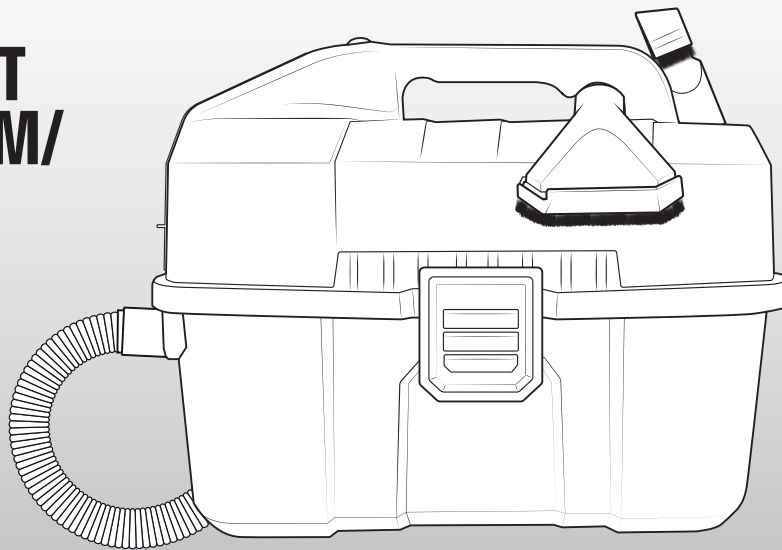

### STANDARD EQUIPMENT

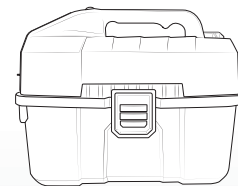

Cordless Wet & Dry Vacuum/Inflator

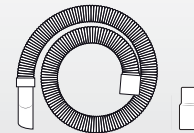

2m Extendable Flexible Hose & Hose Adaptor



2-in-1 Surface Tool, 2-in-1 Crevice Tool & 3 x Inflation Nozzles,

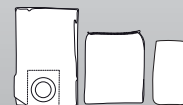

Dust Bag, Filter Bag & Foam Filter

PXWDVS-1080

5 YEAR REPLACEMENT WARRANTY

## WARRANTY

IN ORDER TO MAKE A CLAIM UNDER THIS WARRANTY YOU MUST RETURN THE PRODUCT TO YOUR NEAREST BUNNINGS WAREHOUSE WITH YOUR BUNNINGS REGISTER RECEIPT. PRIOR TO RETURNING YOUR PRODUCT FOR WARRANTY PLEASE TELEPHONE OUR CUSTOMER SERVICE HELPLINE:

**Australia 1800 069 486**  
**New Zealand 0508 069 486**

TO ENSURE A SPEEDY RESPONSE PLEASE HAVE THE MODEL NUMBER AND DATE OF PURCHASE AVAILABLE. A CUSTOMER SERVICE REPRESENTATIVE WILL TAKE YOUR CALL AND ANSWER ANY QUESTIONS YOU MAY HAVE RELATING TO THE WARRANTY POLICY OR PROCEDURE.

### WARNING

The following actions will result in the warranty being void.

- If the tool has been operated on a supply voltage other than that specified on the tool.
- If the tool shows signs of damage or defects caused by or resulting from abuse, accidents or alterations.
- Failure to perform maintenance as set out within the instruction manual.
- If the tool is disassembled or tampered with in any way.

The benefits provided under this warranty are in addition to other rights and remedies which are available to you at law.

Our goods come with guarantees that cannot be excluded at law. You are entitled to a replacement or refund for a major failure and for compensation for any other reasonably foreseeable loss or damage. You are also entitled to have the goods repaired or replaced if the goods fail to be of acceptable quality and the failure does not amount to a major failure.

Generally you will be responsible for all costs associated with a claim under this warranty, however, where you have suffered any additional direct loss as a result of a defective product you may be able to claim such expenses by contacting our customer service helpline above.

### 5 YEAR REPLACEMENT WARRANTY

Your Product is guaranteed for a period of 60 months from the original date of purchase and is intended for DIY (Do It Yourself) use only. If a product is defective it will be replaced in accordance with the terms of this warranty. **Lithium Ion batteries and chargers are covered by a 36 month warranty** and are excluded from the warranty extension. Warranty excludes consumable parts.

# KNOW YOUR PRODUCT

## CORDLESS WET & DRY VACUUM/ INFLATOR

- |                            |                            |
|----------------------------|----------------------------|
| 1. Battery Housing Lid     | 6. Container               |
| 2. On/Off Switch           | 7. Lid Locking Clips       |
| 3. Carry Handle            | 8. Motor Housing           |
| 4. Accessory Storage Slots | 9. Vacuum & Deflation Port |
| 5. Blower & Inflation Port |                            |

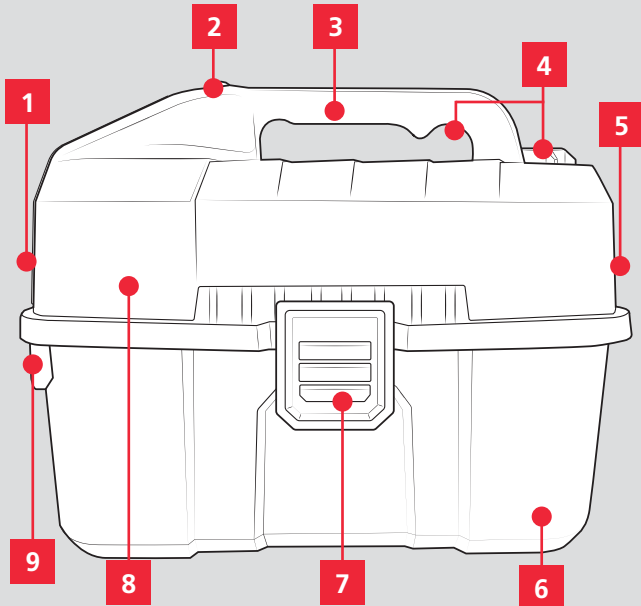

## ACCESSORIES

- |                         |                              |
|-------------------------|------------------------------|
| 10. Dust Bag            | 14. 2-in-1 Crevice Tool      |
| 11. Filter Bag          | 15. Flexible Extendable Hose |
| 12. Foam Filter         | 16. Hose Adaptor             |
| 13. 2-in-1 Surface Tool | 17. 3 x Inflation Nozzles    |

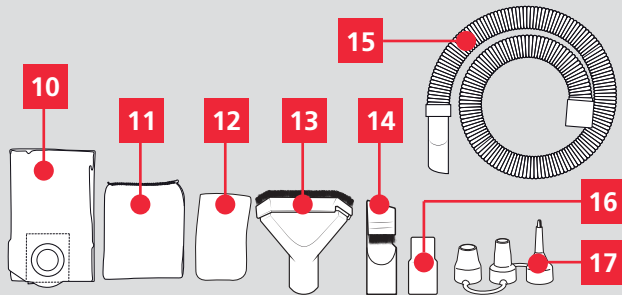

## BATTERY & CHARGER

This tool is compatible with all batteries & chargers from the Ozito Power X Change range.

### ONLINE MANUAL

Scan this QR Code with your mobile device to take you to the online manual.



# SETUP & PREPARATION

## 1. FITTING THE BATTERY

### Installing The Battery Pack

1. Lift the battery slot cover.

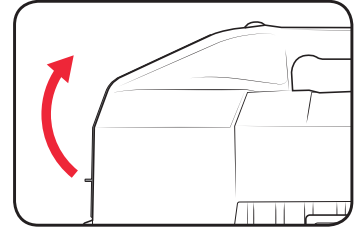

2. Insert a battery into the slot and make sure it slides into place.

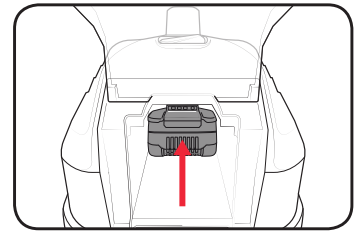

3. Lower the lid back into place and ensure it clicks shut.

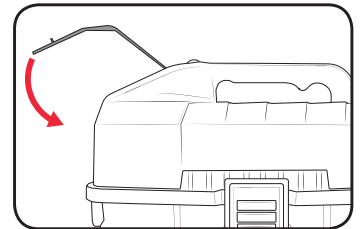

### Removing The Battery Pack

1. Lift the battery slot cover.

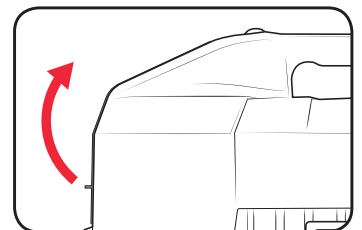

2. Hold down the battery release button and then slide the battery out.

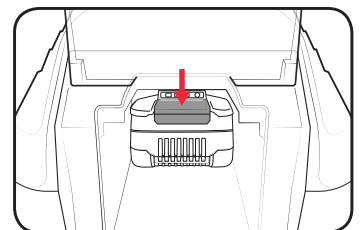

3. Lower the lid back into place and ensure it clicks shut.

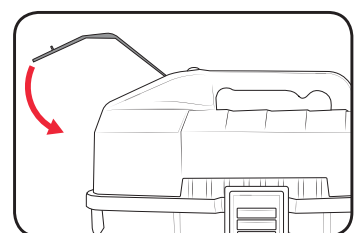

**5 YEAR**  
REPLACEMENT WARRANTY

## 2. FILTER SELECTION

**WARNING!** NEVER USE THE WET & DRY VACUUM WITHOUT A FILTER. ALWAYS ENSURE THAT THE FILTERS ARE PERFECTLY SECURE.

### Fitting the Filter Bag - Vacuuming Dry Matter

For dry vacuum cleaning always use the blue filter bag. Attach the filter bag so that no air is sucked through the filter cage without being filtered.

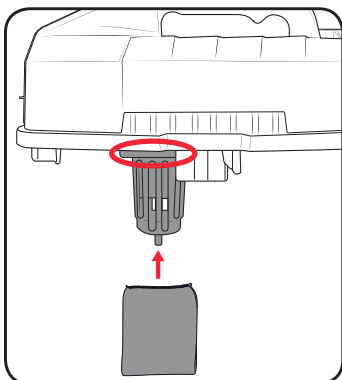

**Note:** Ensure the elastic mouth of the filter bag is fitted over the filter cage base. When fitted correctly, the bag should not slide off the filter cage unit.

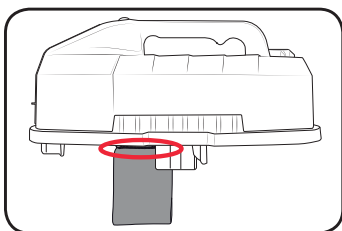

**NOTE:** Do not use the **foam filter** when vacuuming dry matter.

### Fitting the Foam Filter - Vacuuming Liquid

For wet-vacuuming, slip the supplied foam filter over the filter cage.

**Note:** The foam filter does not need to be stretched over the filter cage base.

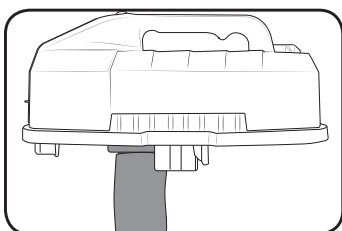

**NOTE:** Do not use the filter bag and/or dust bag when vacuuming liquid.

**WARNING!** SWITCH OFF THE EQUIPMENT IF LIQUID OR FOAM IS EMITTED WITH THE EXHAUST AIR WHEN WET VACUUM CLEANING.

**WARNING!** THE WET & DRY VACUUM IS NOT SUITABLE FOR THE VACUUMING OF COMBUSTIBLE LIQUIDS.

## 3. WASTE DISPOSAL

### Fitting a Dust Bag - Vacuuming Dry Matter

For vacuuming dry waste, it is recommended that you fit a dust bag over the inlet inside the container. This will ensure that the filter bag does not clog up so quickly and help maintain the vacuuming power. A dust bag is suitable for dry vacuuming only. Using the dust bag makes it easier to dispose of the dust that has been collected.

1. To attach, slip the dust bag over the vacuum inlet on the inside of the tank.

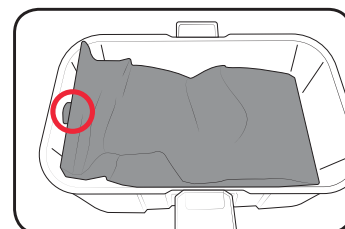

### Emptying The Container

Spills and puddles can be vacuumed directly into the tank with the addition of the foam filter for easy clean up and disposal.

1. Disconnect the hose from the vacuum port.

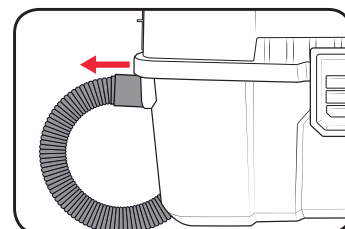

2. Undo the latches on the sides of the unit.

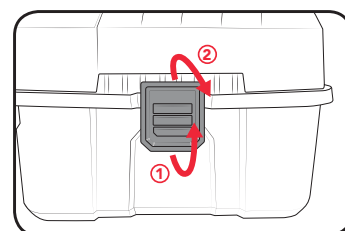

3. Empty the container into a bin or sink depending on the type of waste collected.
4. Clean and dry the container if necessary before replacing the vacuum lid.

**Note:** Only dispose of liquid waste into household sinks & drains if safe to do so. Improper disposal of hazardous waste can cause pollution and harm.

# OPERATION

## 4. TOOL SELECTION

### 2-in-1 Surface Tool

The surface tool is for vacuuming solids and liquids over small to medium areas. Use the brush when vacuuming hard surfaces.

The bristles of the surface tool can be removed when using it on soft surfaces, such as on upholstery or when vacuuming liquids. Gently squeeze the mouth of the tool to disengage the tab, then slide the brush head off the tool.

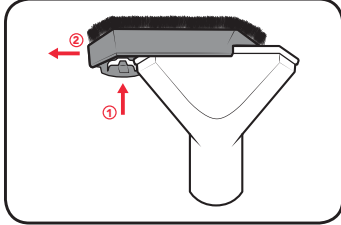

### 2-in-1 Crevice Tool

The crevice tool is designed for cleaning nooks and edges. Use the straight edge for soft surfaces such as carpet or upholstery.

Flip the brush head out to use the crevice tool on hard surfaces.

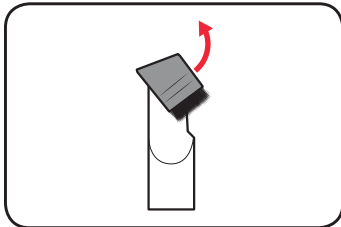

### Inflation Nozzles

The inflation nozzles can be used to suit a range of valve sizes, depending on the item being inflated/deflated. The supplied hose adaptor will need to be fitted to use the nozzles with the hose.

1. To inflate an object, fit the hose onto the blower & inflation port.

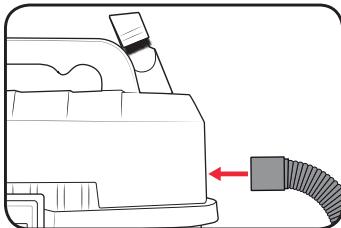

2. Attach the hose adaptor onto the other end of the hose, then connect the required inflation nozzle to the adaptor.

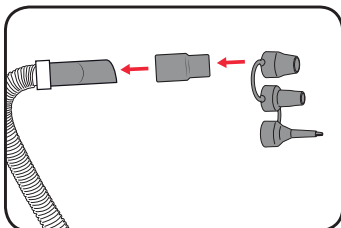

3. To deflate an object, connect the hose to the vacuum & deflation port, then follow Step 2 above.

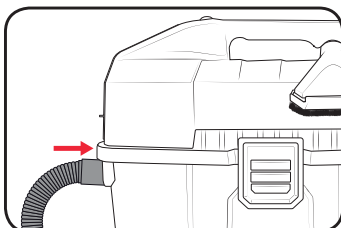

## 4. PORT SELECTION & CONTROLS



**WARNING!** WHEN WET VACUUMING, THE SAFETY FLOAT TURNS OFF THE VACUUM AUTOMATICALLY WHEN THE MAXIMUM LEVEL IS REACHED.

### Vacuuming & Deflation

Connect the suction hose to the vacuum & deflation port.

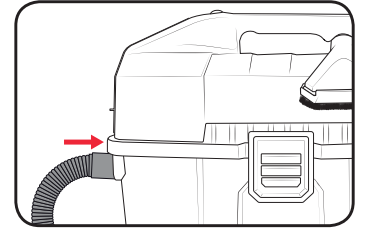

### Blowing & Inflation

Connect the suction hose to the blower and inflation port.

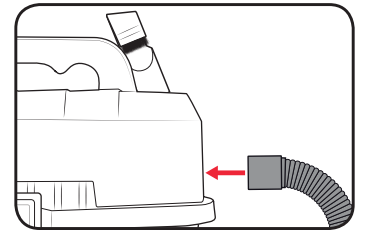

### On/Off Switch

1. To start vacuum, press the on/off switch to the on position ('1').

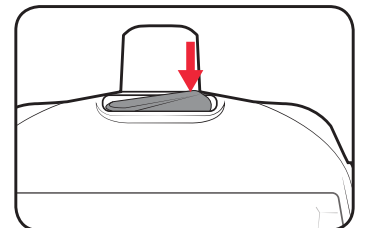

2. To stop vacuum, press the on/off switch to the off position ('0').

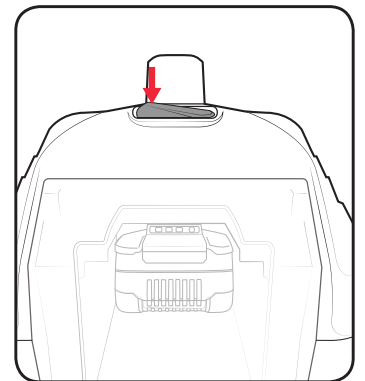

# TROUBLESHOOTING



**WARNING!** ENSURE THE TOOL IS SWITCHED OFF AND THE BATTERY IS REMOVED BEFORE PERFORMING ANY OF THE FOLLOWING TASKS.

Problem	Cause	Remedy
Vacuum is not starting	Battery charge is low	Charge battery
	Battery not inserted properly	Insert battery pack correctly
	Possible clogging	Empty the debris container and clean the filter.
Vacuum is not operating at full capacity	Possible clogging	Empty the debris container and clean the filter.
Motor stops while vacuuming	Battery has no power	Charge battery

# MAINTENANCE



**WARNING!** BEFORE CLEANING OR CARRYING OUT ANY MAINTENANCE PROCEDURE, ENSURE THAT THE BATTERIES HAVE BEEN REMOVED.

## Cleaning

- We recommend that you clean the appliance immediately after you use it.
- Keep the safety devices, air vents, and the motor housing free of dirt and dust as much as possible. Wipe the equipment with a clean cloth.
- Do not use cleaning agents or solvents; these may be aggressive to the plastic parts in the appliance.
- The tank can be cleaned with a damp cloth and some soft soap or under running water, depending on the amount of dirt.
- Clean the foam filter with a little soft soap under running water and allow it to air-dry.

## Storage

Ensure the Wet & Dry Vac has been fully emptied of any dry matter or liquid before it is stored.

Keep all the accessories with the unit to avoid losing them. The 2-in-1 surface tool and 2-in-1 crevice tool can be stored in the accessory storage slots. Ensure the accessories are mounted securely on the slot; press the tools firmly onto the slot to ensure they do not wobble and fall off.

Keep in a dry place out of reach of children.

**Note:** Ozito Industries will not be responsible for any damage or injuries caused by repair of the staple nail gun by an unauthorised person or by mishandling.

# DESCRIPTION OF SYMBOLS

<b>V</b>	Volts	<b>L/s</b>	Litres per second
<b>mbar</b>	Millibar		Double Insulated
	Regulatory Compliance Mark (RCM)		Warning
	Read Instruction Manual		

# CARING FOR THE ENVIRONMENT



Power tools that are no longer usable should not be disposed of with household waste but in an environmentally friendly way. Please recycle where facilities exist. Check with your local council authority for recycling advice.



Recycling packaging reduces the need for landfill and raw materials. Reuse of recycled material decreases pollution in the environment. Please recycle packaging where facilities exist. Check with your local council authority for recycling advice.

# SPARE PARTS

Spare parts can be ordered from the Special Orders Desk at your local Bunnings Warehouse.

For further information, or any parts not listed here, visit [www.ozito.com.au](http://www.ozito.com.au) or contact Ozito Customer Service:

Australia 1800 069 486

New Zealand 0508 069 486

E-mail: [enquiries@ozito.com.au](mailto:enquiries@ozito.com.au)

# ELECTRICAL SAFETY

 **WARNING!** When using mains-powered tools, basic safety precautions, including the following, should always be followed to reduce risk of fire, electric shock, personal injury and material damage.

Read the whole manual carefully and make sure you know how to switch the tool off in an emergency, before operating the tool.

Save these instructions and other documents supplied with this tool for future reference.

The charger has been designed for 230V and 240V only. Always check that the power supply corresponds to the voltage on the rating plate.

**Note:** The supply of 230V and 240V on Ozito tools are interchangeable for Australia and New Zealand.

 This tools charger is double insulated; therefore no earth wire is required.

Note: Double insulation does not take the place of normal safety precautions when operating this tool. The insulation system is for added protection against injury resulting from a possible electrical insulation failure within the tool.

If the supply cord is damaged, it must be replaced by an electrician or a power tool repairer in order to avoid a hazard.

Using an Extension Lead

Always use an approved extension lead suitable for the power input of this tool. Before use, inspect the extension lead for signs of damage, wear and ageing. Replace the extension lead if damaged or defective.

When using an extension lead on a reel, always unwind the lead completely. Use of an extension lead not suitable for the power input of the tool or which is damaged or defective may result in a risk of fire and electric shock.

The power supply for this products charger should be protected by a residual current device (rated at 30mA or less). A residual current device reduces the risk of electric shock.

# GENERAL POWER TOOL SAFETY WARNINGS

 **WARNING!** Read all safety warnings and all instructions. Failure to follow the warnings and instructions may result in electric shock, fire and/or serious injury.

Save all warnings and instructions for future reference. The term "power tool" in the warnings refers to your mains-operated (corded) power tool or battery-operated (cordless) power tool.

## 1. Work area safety

- Keep work area clean and well lit.** Cluttered or dark areas invite accidents.
- Do not operate power tools in explosive atmospheres, such as in the presence of flammable liquids, gases or dust.** Power tools create sparks which may ignite the dust or fumes.
- Keep children and bystanders away while operating a power tool.** Distractions can cause you to lose control.

## 2. Electrical safety

- Power tool plugs must match the outlet.** Never modify the plug in any way. Do not use any adapter plugs with earthed (grounded) power tools. Unmodified plugs and matching outlets will reduce risk of electric shock.
- Avoid body contact with earthed or grounded surfaces, such as pipes, radiators, ranges and refrigerators.** There is an increased risk of electric shock if your body is earthed or grounded.
- Do not expose power tools to rain or wet conditions.** Water entering a power tool will increase the risk of electric shock.
- Do not abuse the cord.** Never use the cord for carrying, pulling or unplugging the power tool. Keep cord away from heat, oil, sharp edges or moving parts. Damaged or entangled cords increase the risk of electric shock.
- When operating a power tool outdoors, use an extension cord suitable for outdoor use.** Use of a cord suitable for outdoor use reduces the risk of electric shock.

## 3. Personal safety

- Stay alert, watch what you are doing and use common sense when operating a power tool.** Do not use a power tool while you are tired or under the influence of drugs, alcohol or medication. A moment of inattention while operating power tools may result in serious personal injury.
- Use personal protective equipment.** Always wear eye protection. Protective equipment such as dust mask, non-skid safety shoes, hard hat, or hearing protection used for appropriate conditions will reduce personal injuries.
- Prevent unintentional starting.** Ensure the switch is in the off-position before connecting to power source and/or battery pack, picking up or carrying the tool. Carrying power tools with your finger on the switch or energising power tools that have the switch on invites accidents.

- Remove any adjusting key or wrench before turning the power tool on.** A wrench or a key left attached to a rotating part of the power tool may result in personal injury.
- Do not overreach.** Keep proper footing and balance at all times. This enables better control of the power tool in unexpected situations.
- Dress properly.** Do not wear loose clothing or jewellery. Keep your hair, clothing and gloves away from moving parts. Loose clothes, jewellery or long hair can be caught in moving parts.
- If devices are provided for the connection of dust extraction and collection facilities, ensure these are connected and properly used.** Use of dust collection can reduce dust-related hazards.
- Do not let familiarity gained from frequent use of tools allow you to become complacent and ignore tool safety principles.** A careless action can cause severe injury within a fraction of a second.

## 4. Power tool use and care

- Do not force the power tool.** Use the correct power tool for your application. The correct power tool will do the job better and safer at the rate for which it was designed.
- Do not use the power tool if the switch does not turn it on and off.** Any power tool that cannot be controlled with the switch is dangerous and must be repaired.
- Disconnect the plug from the power source and/or the battery pack from the power tool before making any adjustments, changing accessories, or storing power tools.** Such preventive safety measures reduce the risk of starting the power tool accidentally.
- Store idle power tools out of the reach of children and do not allow persons unfamiliar with the power tool or these instructions to operate the power tool.** Power tools are dangerous in the hands of untrained users.
- Maintain power tools.** Check for misalignment or binding of moving parts, breakage of parts and any other condition that may affect the power tool's operation. If damaged, have the power tool repaired before use. Many accidents are caused by poorly maintained power tools.
- Keep cutting tools sharp and clean.** Properly maintained cutting tools with sharp cutting edges are less likely to bind and are easier to control.
- Use the power tool, accessories and tool bits etc. in accordance with these instructions, taking into account the working conditions and the work to be performed.** Use of the power tool for operations different from those intended could result in a hazardous situation.
- Keep handles and grasping surfaces dry, clean and free from oil and grease.** Slippery handles and grasping surfaces do not allow for safe handling and control of the tool in unexpected situations.

## 5. Service

- Have your power tool serviced by a qualified repair person using only identical replacement parts.** This will ensure that the safety of the power tool is maintained.

# WET & DRY VACUUM SAFETY WARNINGS

 This appliance is not intended for use by persons (including children) with reduced physical, sensory or mental capabilities, or lack of experience and knowledge, unless they have been given supervision or instruction concerning use of the appliance by a person responsible for their safety.

- Do not leave appliance unattended when connected to the power supply. Remove battery when not in use and before servicing and cleaning.
- To avoid electric shock, do not expose to rain. Store indoors.
- Never use in the presence of explosive liquids, vapours or explosive dust – such as coal or grain.
- Use only manufacturer's recommended attachments and consumables.
- Never modify the cleaner in any way - this is dangerous and will invalidate the warranty.
- Do not use cleaner without the correct filter in place.
- If motor sound becomes higher pitched always check for the following:
  - Blocked hose or accessory.
  - Blocked filter.
  - Full container.
- When lifting the unit, always lift it with the handle or under rim of container. Beware of excess weight.

- Always ensure the motor housing is securely locked onto the container before using or transporting the vacuum.
- The wet and dry vacuum cleaner is designed for wet and dry vacuuming using the appropriate filter. The appliance is not suitable for the vacuuming of combustible, explosive or harmful substances.
- Do not aim the hose at other persons or animals.
- Never pick up asbestos or asbestos dust.
- Wood dust and shavings in a confined area can give rise to fire or an explosion.
- Guard against possible ignition sources.
- Do not pick up any material that is burning or smouldering such as metal grinding dust, cigarette ends, matches etc.
- Always switch the unit off before changing attachments, filters and emptying the tank.
- Always check that the filter is clear and not blocked. Keep all openings clear of any blockages.
- The equipment is to be used only for its prescribed purpose. Any other use is deemed to be a case of misuse. The user / operator and not the manufacturer will be liable for any damage or injuries of any kind caused as a result of this.