

Installation Instructions

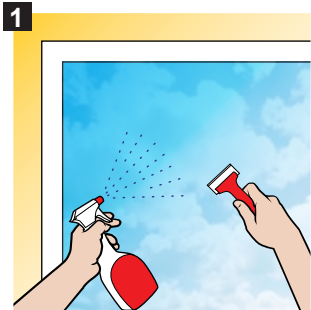

Tools Required

- Spray Bottle
- Application Solution
(2% baby shampoo in filtered water)
- Squeegee/Applicator
- Craft Knife
- Lint-free Cloth
- Straight Edge
- Measuring Tape



1 Thoroughly clean glass to remove all dirt and debris using an ammonia-free cleaner, scraper & lint-free cloth.

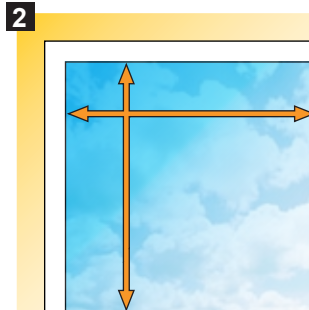

2 Measure width and height of glass area to cover using a metal tape measure for accuracy.

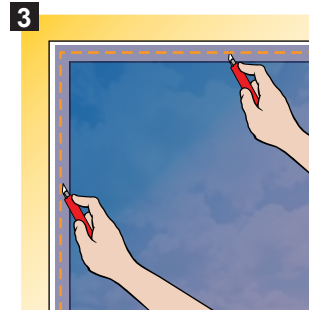

3 On a clean flat surface, cut window film 20-25mm wider than required along all sides to ensure coverage.

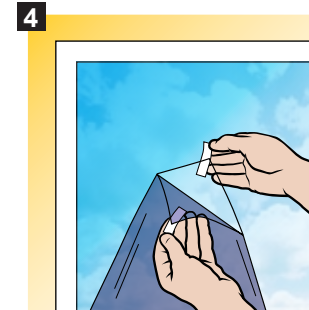

4 Peel away backing by placing a small piece of masking tape front and back on 1 corner of film and separate.

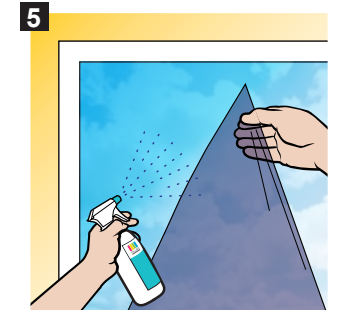

5 Apply a generous amount of **Application Solution** to glass and **BOTH** sides of window film to allow for easy installation.

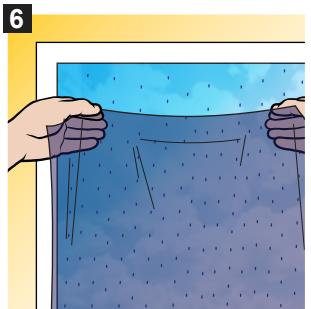

6 Place adhesive side of film against glass and gently manoeuvre film into position. Smooth out bubbles by hand.

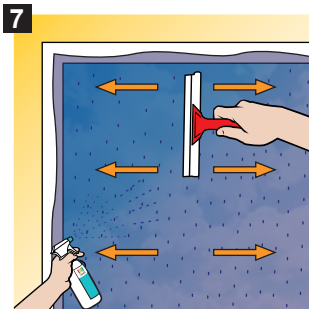

7 For extra lubrication spray more **Application Solution**. Starting from top-centre, use **Applicator Tool** to work out bubbles to edges.

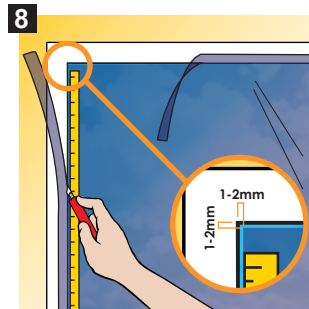

8 Using a Straight Edge, trim excess film leaving a 1-2mm gap for any water residue to escape.

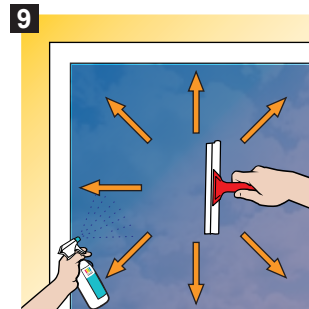

9 Lightly spray with more **Application Solution** and work out any remaining bubbles. Use cloth to capture excess moisture.

This product is for internal use only on flat glass.

Do not install inside showers, on hot glass or under 10°C.

Not to be used on double glazed windows or as automotive film.