

ozito

ELECTRIC AIR PUMP

130W

INSTRUCTION MANUAL

SPECIFICATIONS

Voltage:	220-240V ~50Hz
Power:	130W
Max. Current:	0.62A
Max. Pressure:	0.6PSI
Flow Rate:	440L/Min
Inflation Time:	Under 2min (double air mattress)
Max. Run Time:	15min
Weight:	0.55kg

ozito.com.au

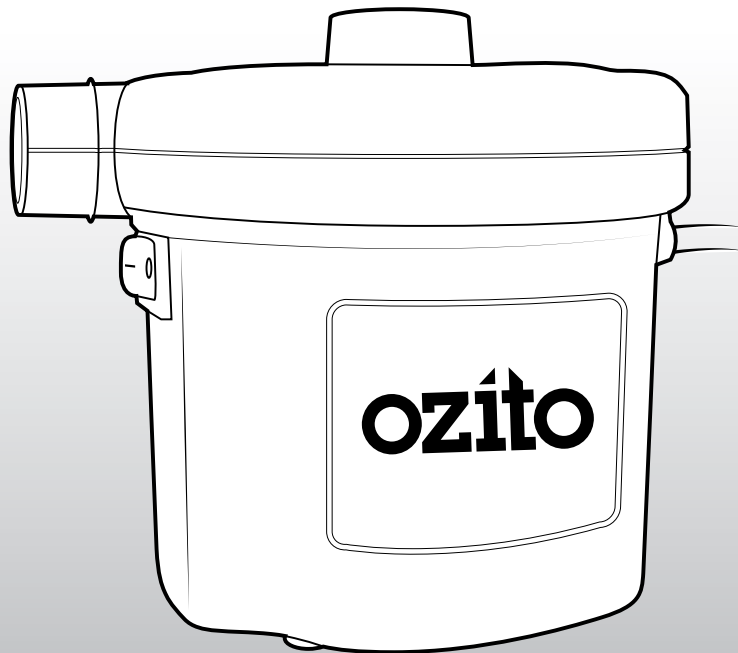

WHAT'S IN THE BOX



Electric Air Pump

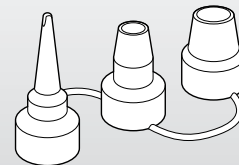

3 x Inflation Adaptors

3 YEAR REPLACEMENT WARRANTY

IDP-2000

KNOW YOUR PRODUCT

ELECTRIC AIR PUMP

- 1 Inflation Port
- 2 On/Off Switch
- 3 Air Pump Housing
- 4 Deflation Port
- 5 Power Cord

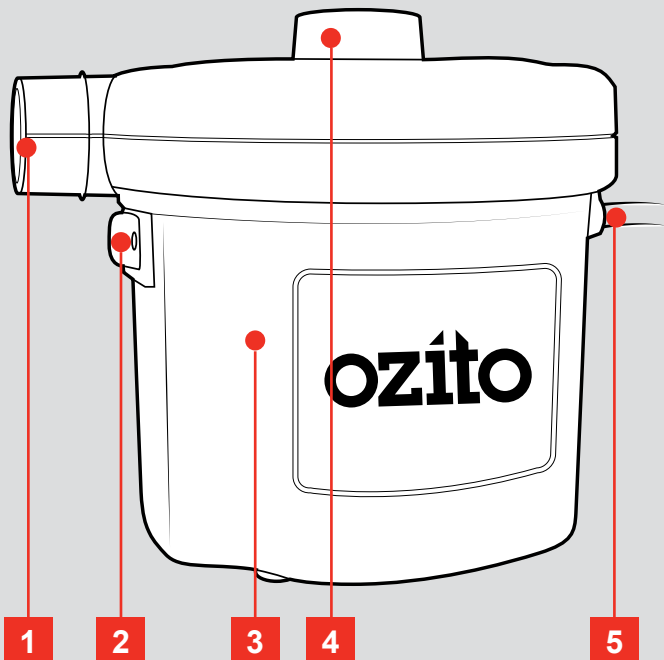

ACCESSORIES

- 6 Inflation Adaptors

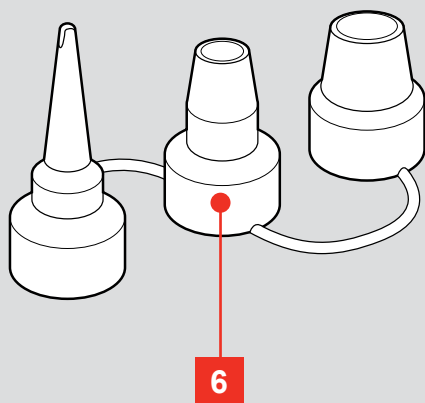

ONLINE MANUAL

Scan this QR Code with your mobile device to take you to the online manual.



SETUP & PREPARATION

1. ADAPTORS



WARNING: ENSURE THE TOOL IS SWITCHED OFF AND DISCONNECTED FROM THE POWER SUPPLY BEFORE PERFORMING ANY OF THE FOLLOWING STEPS.

Fitting an Adaptor

- 1 Align the required adaptor with the port.

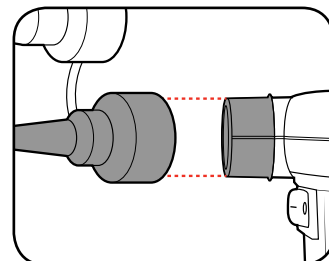

- 2 Push the adaptor onto the air port tightly.

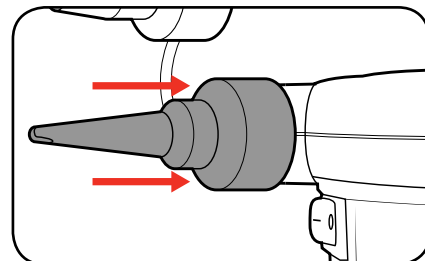

Removing Adaptors

- 1 To remove, simply pull the adaptor from the air port.

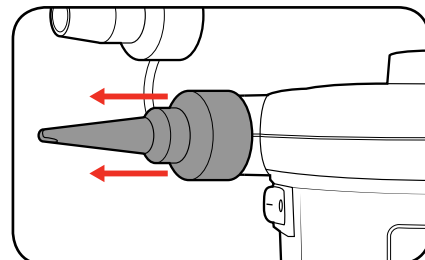

3 YEAR REPLACEMENT WARRANTY

OPERATION

2. SWITCHING ON & OFF



CAUTION! THE POWER SUPPLY FOR THIS PRODUCT SHOULD BE PROTECTED BY A RESIDUAL CURRENT DEVICE (RATED AT 30mA OR LESS).

- 1 To start operating the air pump, push the on/off switch to the on position.

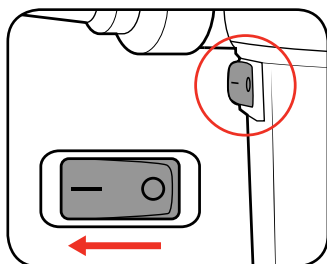

- 2 To stop operation, push the on/off switch to the off position.

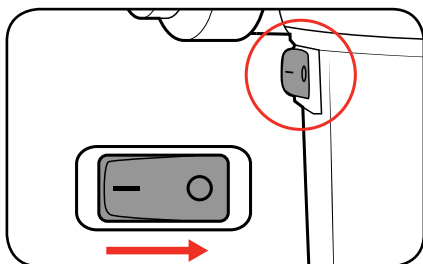

WARNING: COMPRESSED AIR CAN BE DANGEROUS. NEVER POINT THE OUTLET NOZZLE TOWARDS ANY PART OF YOUR BODY OR AT ANOTHER PERSON.

3. INFLATING ITEMS



IMPORTANT: BEFORE CONNECTING OR DISCONNECTING ACCESSORIES, ALWAYS MAKE SURE THAT THE AIR PUMP IS TURNED OFF.

- 1 Fit the required adaptor onto the inflation port tightly.

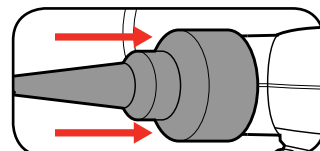

- 2 Insert the adaptor into the valve of the inflatable item.

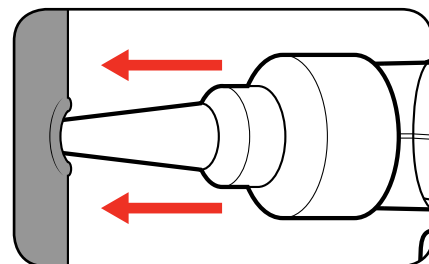

CAUTION: ENSURE THE DEFLATION PORT IS NOT OBSTRUCTED, OTHERWISE THE UNIT COULD OVERHEAT.

- 3 Switch the air pump on at the on/off switch.

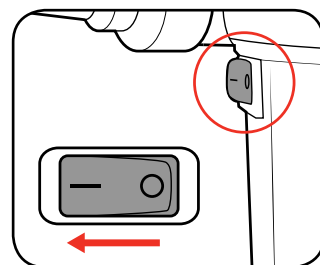

- 4 Once the item is inflated, switch the air pump off and then remove the adaptor from the valve.

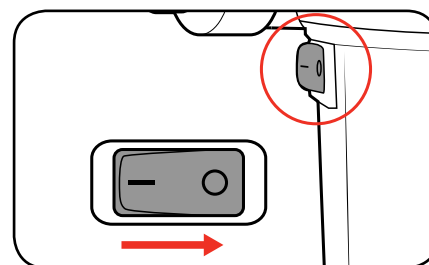

WARNING: AVOID INFLATING THE OBJECTS ABOVE THE RECOMMENDED INFLATION PRESSURE. THIS MAY LEAD TO DAMAGE AND/OR INJURIES.

4. DEFLATING ITEMS



IMPORTANT: BEFORE CONNECTING OR DISCONNECTING ACCESSORIES, ALWAYS MAKE SURE THAT THE AIR PUMP IS TURNED OFF.

- 1 Fit the required adaptor onto the deflation port at the top of the unit tightly.

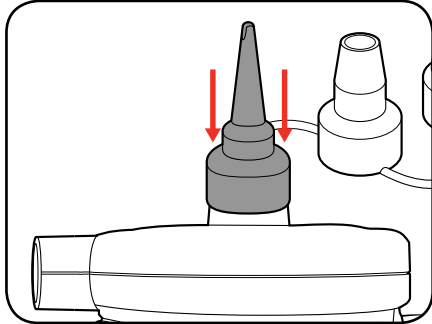

- 2 Insert the adaptor into the valve of the inflatable item.

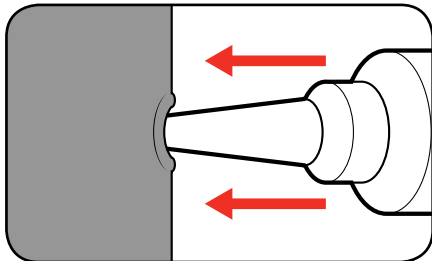

CAUTION: ENSURE THE INFLATION PORT IS NOT OBSTRUCTED, OTHERWISE THE UNIT COULD OVERHEAT.

- 3 Switch the air pump on at the on/off switch.

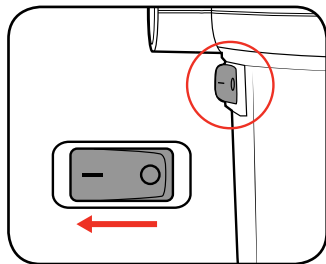

- 4 Once the item is deflated, switch the air pump off and then remove the adaptor from the valve.

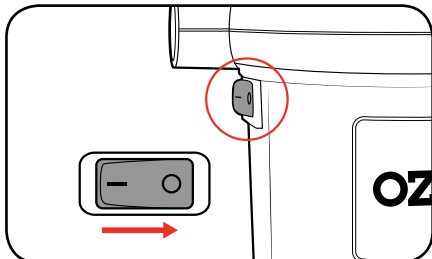

MAINTENANCE



WARNING: BEFORE CLEANING OR CARRYING OUT ANY MAINTENANCE PROCEDURE, ENSURE THE UNIT IS SWITCHED OFF, DISCONNECTED FROM THE POWER SUPPLY AND ALLOWED TO COOL DOWN.

Cleaning

- Keep the ventilation vents of the air pump clean at all times, if possible, prevent foreign matter from entering the vents.
- After each use, blow air through the air pump housing to ensure it is free from all dust particles which may build up. Build up of dust particles may cause the air pump to overheat and fail.
- If the enclosure of the air pump requires cleaning do not use solvents but a moist soft cloth only. Never let any liquid get inside the product; never immerse any part of the air pump into a liquid.

Note: Ozito Industries will not be responsible for any damage or injuries caused by the repair of the air pump by an unauthorised person or by mishandling of the product.

IMPORTANT: STORE THE AIR PUMP ONLY IN A DRY LOCATION WHICH IS NOT ACCESSIBLE TO UNAUTHORISED PERSONS.

DESCRIPTION OF SYMBOLS

V	Volts	Hz	Hertz
~	Alternating current	W	Watts
/min	Revolutions or reciprocation per minute	n_o	No load speed
A	Amps	°C	Degrees Celsius
	Double insulated	kPa	Pressure rating (kilopascals)
bar	Pressure rating	L	Litres
	Regulator compliance mark		Read instruction manual
	Warning		

CARING FOR THE ENVIRONMENT



Power tools that are no longer usable should not be disposed of with household waste but in an environmentally friendly way. Please recycle where facilities exist. Check with your local council authority for recycling advice.



Recycling packaging reduces the need for landfill and raw materials. Reuse of recycled material decreases pollution in the environment. Please recycle packaging where facilities exist. Check with your local council authority for recycling advice.

TROUBLESHOOTING

Problem	Cause	Solution
The air pump does not start	Cord not connected to the power	Connect the power cord to a 240V power outlet
	On/off switch not in on position	Push the on/off switch into the on position
Adaptors disconnect when the pump switches on	Loose adaptor	Ensure the adaptor is pushed tightly onto the air port
Pump is operating but the inflatable item is not inflating/deflating	Some inflatable items have a check valve that require pinching or unscrewing	Pinch or unscrew the items valve while operating the pump
Pump is overheating	While inflating, the deflation port is being obstructed, restricting the flow of the air pump	Ensure the deflation port is free of any obstructions
	While deflating, the inflation port is being obstructed, restricting the flow of the air pump	Ensure the inflation port is free of any obstructions

SPARE PARTS

Spare parts can be ordered from the Special Orders Desk at your local Bunnings Warehouse.

For further information, or any parts not listed here, visit www.ozito.com.au or contact Ozito Customer Service:

Australia 1800 069 486

New Zealand 0508 069 486

E-mail: enquires@ozito.com.au

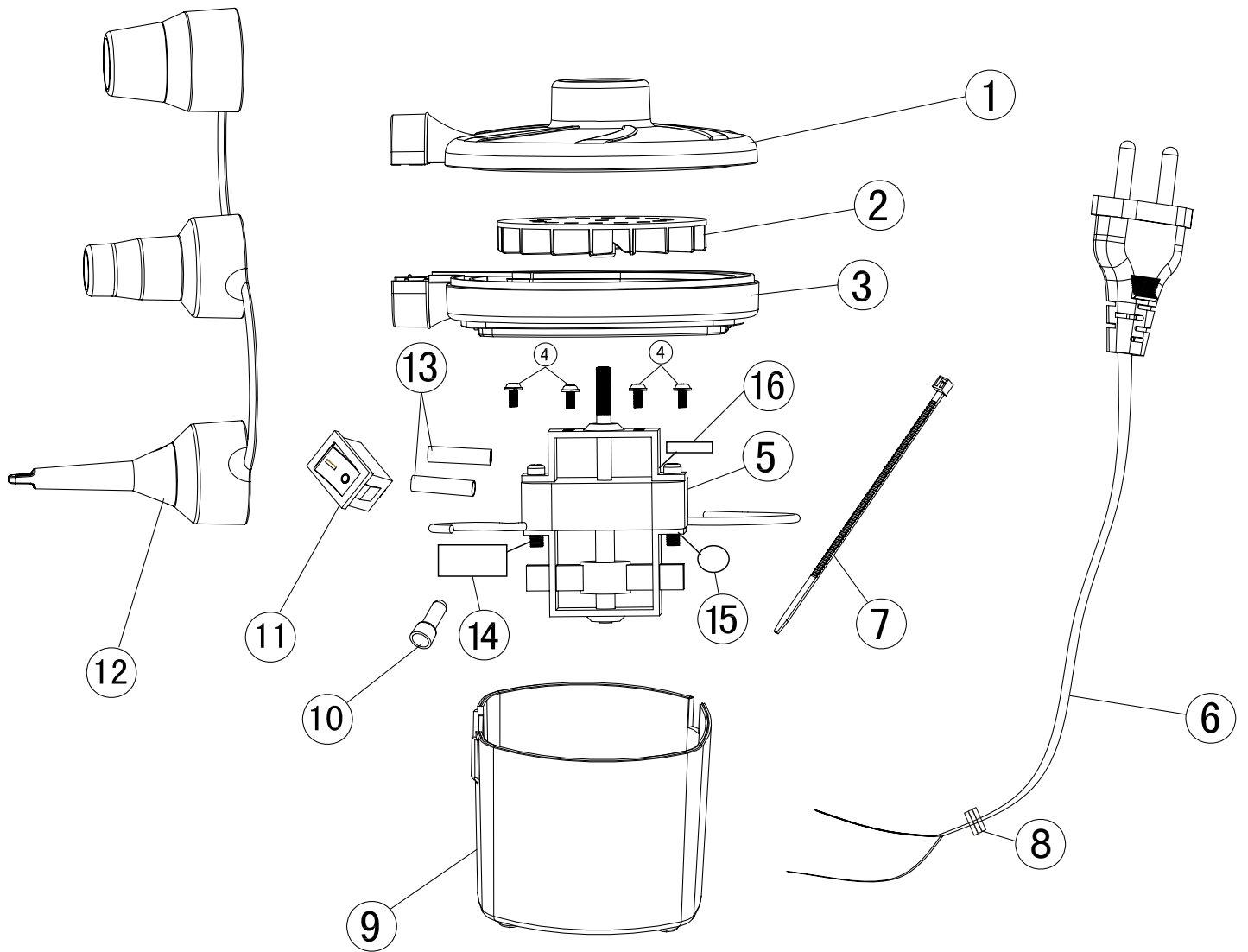

How To Order

Available spare parts can be ordered through the Special Orders Desk at any Bunnings Warehouse. If you have any further questions, please contact Ozito Customer Service on:

Australia: 1800 069 486

New Zealand: 0508 069 486

enquiries@ozito.com.au

ELECTRICAL SAFETY

 **WARNING!** When using mains-powered tools, basic safety precautions, including the following, should always be followed to reduce risk of fire, electric shock, personal injury and material damage.

Read the whole manual carefully and make sure you know how to switch the tool off in an emergency, before operating the tool.

Save these instructions and other documents supplied with this tool for future reference.

The electric motor has been designed for 230V and 240V only. Always check that the power supply corresponds to the voltage on the rating plate.

Note: The supply of 230V and 240V on Ozito tools are interchangeable for Australia and New Zealand.



This tool is double insulated in accordance with AS/NZS 60335-1; therefore no earth wire is required.

The supply cord cannot be replaced. If the cord is damaged the appliance should be scrapped.

Note: Double insulation does not take the place of normal safety precautions when operating this tool. The insulation system is for added protection against injury resulting from a possible electrical insulation failure within the tool.

Using an Extension Lead

Always use an approved extension lead suitable for the power input of this tool. Before use, inspect the extension lead for signs of damage, wear and ageing. Replace the extension lead if damaged or defective. When using an extension lead on a reel, always unwind the lead completely. Use of an extension lead not suitable for the power input of the tool or which is damaged or defective may result in a risk of fire and electric shock.

GENERAL POWER TOOL SAFETY WARNINGS-PERSONAL SAFETY

 **WARNING!** Read all safety warnings and all instructions. Failure to follow the warnings and instructions may result in electric shock, fire and/or serious injury. Save all warnings and instructions for future reference. The term "power tool" in the warnings refers to your mains-operated (corded) power tool or battery-operated (cordless) power tool.

1. Work area safety

- Keep work area clean and well lit.** Cluttered or dark areas invite accidents.
- Do not operate power tools in explosive atmospheres, such as in the presence of flammable liquids, gases or dust.** Power tools create sparks which may ignite the dust or fumes.
- Keep children and bystanders away while operating a power tool.** Distractions can cause you to lose control.

2. Electrical safety

- Power tool plugs must match the outlet. Never modify the plug in any way. Do not use any adapter plugs with earthed (grounded) power tools.** Unmodified plugs and matching outlets will reduce risk of electric shock.
- Avoid body contact with earthed or grounded surfaces, such as pipes, radiators, ranges and refrigerators.** There is an increased risk of electric shock if your body is earthed or grounded.
- Do not expose power tools to rain or wet conditions.** Water entering a power tool will increase the risk of electric shock.
- Do not abuse the cord. Never use the cord for carrying, pulling or unplugging the power tool. Keep cord away from heat, oil, sharp edges or moving parts.** Damaged or entangled cords increase the risk of electric shock.
- When operating a power tool outdoors, use an extension cord suitable for outdoor use.** Use of a cord suitable for outdoor use reduces the risk of electric shock.
- If operating a power tool in a damp location is unavoidable, use a residual current device (RCD) protected supply.** Use of an RCD reduces the risk of electric shock.

3. Personal safety

- Stay alert, watch what you are doing and use common sense when operating a power tool. Do not use a power tool while you are tired or under the influence of drugs, alcohol or medication.**
A moment of inattention while operating power tools may result in serious personal injury.
- Use personal protective equipment. Always wear eye protection.** Protective equipment such as dust mask, non-skid safety shoes, hard hat, or hearing protection used for appropriate conditions will reduce personal injuries.
- Prevent unintentional starting. Ensure the switch is in the off-position before connecting to power source and/or battery pack, picking up or carrying the tool.** Carrying power tools with your finger on the switch or energising power tools that have the switch on invites accidents.

- Remove any adjusting key or wrench before turning the power tool on.**

A wrench or a key left attached to a rotating part of the power tool may result in personal injury.

- Do not overreach. Keep proper footing and balance at all times.** This enables better control of the power tool in unexpected situations.
 - Dress properly. Do not wear loose clothing or jewellery. Keep your hair, clothing and gloves away from moving parts.** Loose clothes, jewellery or long hair can be caught in moving parts.
 - If devices are provided for the connection of dust extraction and collection facilities, ensure these are connected and properly used.** Use of dust collection can reduce dust-related hazards.
- ## 4. Power tool use and care
- Do not force the power tool. Use the correct power tool for your application.** The correct power tool will do the job better and safer at the rate for which it was designed.
 - Do not use the power tool if the switch does not turn it on and off.** Any power tool that cannot be controlled with the switch is dangerous and must be repaired.
 - Disconnect the plug from the power source and/or the battery pack from the power tool before making any adjustments, changing accessories, or storing power tools.** Such preventive safety measures reduce the risk of starting the power tool accidentally.
 - Store idle power tools out of the reach of children and do not allow persons unfamiliar with the power tool or these instructions to operate the power tool.** Power tools are dangerous in the hands of untrained users.
 - Maintain power tools. Check for misalignment or binding of moving parts, breakage of parts and any other condition that may affect the power tool's operation. If damaged, have the power tool repaired before use.** Many accidents are caused by poorly maintained power tools.
 - Keep cutting tools sharp and clean.** Properly maintained cutting tools with sharp cutting edges are less likely to bind and are easier to control.
 - Use the power tool, accessories and tool bits etc. in accordance with these instructions, taking into account the working conditions and the work to be performed.** Use of the power tool for operations different from those intended could result in a hazardous situation.
- ## 5. Service
- Have your power tool serviced by a qualified repair person using only identical replacement parts.** This will ensure that the safety of the power tool is maintained.

AIR PUMP SAFETY WARNINGS

This appliance is not intended for use by persons (including children) with reduced physical, sensory or mental capabilities, or lack of experience and knowledge, unless they have been given supervision or instruction concerning use of the appliance by a person responsible for their safety.

Children should be supervised to ensure that they do not play with the appliance.

- Do not place the hose end against any part of your body when turned on, as this may infuse air into your blood stream putting your health at serious risk.
- Do not make any alterations to this air pump. Only use the adaptors supplied with this product.
- Use this product only in accordance with operation instructions included in this manual.
- It is not suggested that the air pump work continuously for more than 15 minutes. If 15 minutes of use has been reached, turn it off and let it cool for 8 minutes before using again.
- If the pump is making abnormal sounds or its temperature is quite high, turn off the power straight away and let it cool for at least 10 minutes before trying again. Improper use may result in damage of the air pump.
- Do not leave unattended and operating. Keep out of reach of children.
- Put the air pump in a dry place if it is not in use for an extended period of time.
- Keep the air pump away from flammable liquid or gas. Do not allow the pump to become wet.
- Never put the connector and adaptors into your mouth, ear or eye. They are not

toys.

- Avoid inserting hands into the inlets/outlets of the air pump while it is connected to power.
- Before using the air pump, always inspect it visually. Do not use the pump if it is cracked and/or damaged. If the pump is damaged, contact Ozito customer service.
- Never work or perform maintenance on the pump without first making sure it has been disconnected from the mains power.

IMPORTANT:

- The electrical connection must always be made in a dry area. Make sure that electrical connections are protected from inundations.
- Protect the plug and the power cable from heat, oil or sharp edges.
- If damaged, The power cable must be replaced by a qualified electrician.

WARRANTY

IN ORDER TO MAKE A CLAIM UNDER THIS WARRANTY YOU MUST RETURN THE PRODUCT TO YOUR NEAREST BUNNINGS WAREHOUSE WITH YOUR BUNNINGS REGISTER RECEIPT. PRIOR TO RETURNING YOUR PRODUCT FOR WARRANTY PLEASE TELEPHONE OUR CUSTOMER SERVICE HELPLINE:

Australia 1800 069 486

New Zealand 0508 069 486

TO ENSURE A SPEEDY RESPONSE PLEASE HAVE THE MODEL NUMBER AND DATE OF PURCHASE AVAILABLE. A CUSTOMER SERVICE REPRESENTATIVE WILL TAKE YOUR CALL AND ANSWER ANY QUESTIONS YOU MAY HAVE RELATING TO THE WARRANTY POLICY OR PROCEDURE.

The benefits provided under this warranty are in addition to other rights and remedies which are available to you at law.

Our goods come with guarantees that cannot be excluded at law. You are entitled to a replacement or refund for a major failure and for compensation for any other reasonably foreseeable loss or damage. You are also entitled to have the goods repaired or replaced if the goods fail to be of acceptable quality and the failure does not amount to a major failure.

Generally you will be responsible for all costs associated with a claim under this warranty, however, where you have suffered any additional direct loss as a result of a defective product you may be able to claim such expenses by contacting our customer service helpline above.

3 YEAR REPLACEMENT WARRANTY

Your product is guaranteed for a period of **36 months from the original date of purchase**. If a product is defective it will be replaced in accordance with the terms of this warranty. Warranty excludes consumable parts, for example: valve adaptors etc.

WARNING

The following actions will result in the warranty being void.

- If the tool has been operated on a supply voltage other than that specified on the tool.
- If the tool shows signs of damage or defects caused by or resulting from abuse, accidents or alterations.
- Failure to perform maintenance as set out within the instruction manual.
- If the tool is disassembled or tampered with in any way.
- Professional, industrial or high frequency use.