

# MR502

## Martini

Oliveri®

### RIGHT HAND BOWL SINK

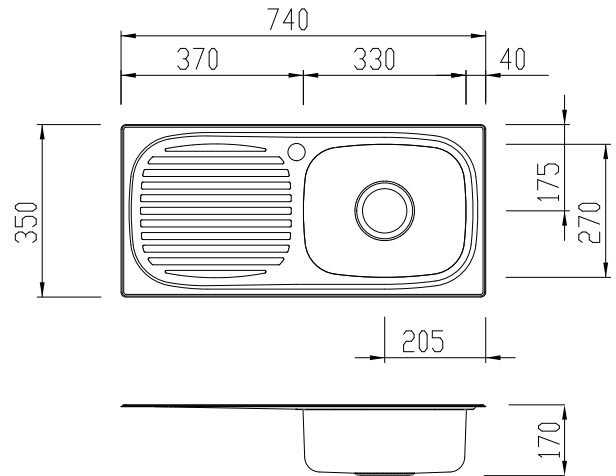

### INCLUDED ACCESSORIES

AC14



AC02

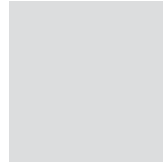
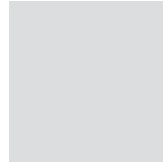
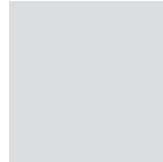
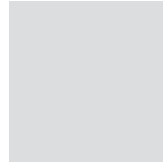

### RECOMMENDED TAPWARE

PA113/2



MV617/6



### OPTIONAL ACCESSORIES

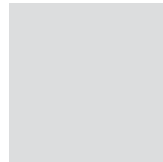
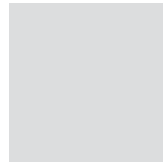
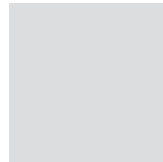
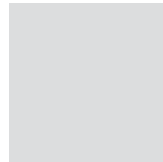
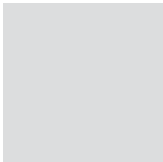
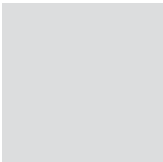

### SPECIFICATIONS

#### Description

3/4 bowl inset sink with drainer

#### Sink Size

740W x 350H

#### 3/4 Bowl

270W x 330H x 155D / 12L

#### Construction

2 piece, bowls & drainer seam welded

#### Material

304 grade, 18/10 polished stainless steel (0.8mm thick)

#### Installation

Inset recommended.

#### Fixings

Adjustable clips and sealing foam supplied

#### Cut Out Template

720 x 330 x 15mm radius

#### Min Cabinet Size

500mm

#### Tap holes

Available 0 or 1 tap hole (specify when ordering)

#### Waste fittings

1 x 90mm basket waste included

#### Overflow

Not available

#### Carton Size

757 x 367 x 182mm

#### Weight

4.0kg

#### Warranty

Lifetime manufacturer's warranty (refer to oliverisinks.com)

For more information call **1300 13 7465** or visit **www.oliverisinks.com**

