

BORAL TIMBER
Build something great™



Product **installation** guide

Boral 19mm solid strip flooring
Boral Overlay solid strip flooring
Boral Block Parquetry
Boral Decking



Promoting sustainable forest management

Contents

1. INTRODUCTION	1
2. PRODUCT DESCRIPTION	1
2.1 Timber Flooring	1
2.2 Decking	2
3. PRODUCT HANDLING ON SITE	2
4. TIMBER FLOORING	3
4.1 Properties of Timber	3
4.2 Prior to Installation	3
4.3 Installation	7
4.3.1 19mm solid strip flooring installation	8
4.3.2 Overlay solid strip flooring installation	12
4.3.3 Block Parquetry installation	17
4.4 Important points to remember	19
4.5 Post installation care and maintenance	19
5. DECKING	19
5.1 Introduction	19
5.2 Prior to Installation	20
5.3 Installing Boral Decking	20
5.4 Decking Care and Maintenance	20
6. SAFE WORKING PRACTICES	21

1. Introduction

Welcome to the Product Installation Guide for timber flooring and decking. The final result of installing a Boral timber floor or deck in an Australian species is dependant on the use of the following guidelines.

The following should only be used as a guide and the installer should apply all Australian Standards, BCA requirements, and best practices when installing. The sub floor moisture and under floor humidity must comply with BCA and AS 1684 requirements. This must include the relevant safety protocols required. This guide should not be used as the sole means of direction.

Boral Timber recommends that a qualified professional timber flooring contractor installs, sands and finishes a Boral hardwood timber floor. It is recommended that a qualified person such as a licensed builder or carpenter installs Boral hardwood timber decking products.

Read all instructions before starting and take the time to plan the job properly. Please check all material for faults or defects prior to installation.

Timber flooring boards need to be mixed on the floor according to colour and feature. This is at the discretion of the installer and the end user.

If there are any problems before or during the laying of a Boral Timber product, stop and do not continue laying. Contact Boral Timber immediately on 1800 818 317 or email timberspec@boral.com.au for further advice.

2. Product description

This installation guide covers the installation of the following Boral timber products.

2.1 TIMBER FLOORING

Boral Timber flooring is ideal for indoor domestic and commercial applications but is not recommended for wet areas such as laundries or bathrooms. For installation over heated subfloors please contact Boral Timber on 1800 818 317 for additional instructions.

This installation guide does not apply to speciality flooring applications such as sports floors and some commercial applications.

Boral 19mm solid strip flooring

Boral 19mm (and thicker) solid strip flooring is structurally designed to be laid directly onto joists, battens or plywood over concrete, or nailed to existing timber flooring. Tongue and groove joints on both sides and ends of the board ensure a continuous and stable surface. End matching removes the need for ends to fall directly over a joist or batten. This results in less cutting and less waste. Boards up to 130mm can be secret nailed or top nailed. For secret nailing boards wider than 85mm please read the Secret Fixing procedure on [page 10](#). 180mm boards should be face (top) nailed in accordance with AS 1684.2.

Suitable subfloors

Boral 19mm is designed for any subfloor that is structurally sound, level, flat, clean and dry such as:

- Bearers and joists
- Concrete slab
- Sheet flooring such as plywood or particleboard
- Existing strip timber floors

Boral Overlay solid strip flooring

Boral Overlay solid strip flooring includes 10mm, 13mm and 14mm thickness. Boral Overlay is a non-structural solid hardwood tongue and groove strip flooring profile designed to be installed over a solid structural subfloor. It is precision-milled to either 80mm or 130mm wide. Tongue and groove joints ensure a continuous and stable surface.

Suitable subfloors

Boral Overlay is designed for a subfloor that is structurally sound, level, flat, clean and dry such as:

- Concrete slab (80x10, 80x13 only)
- Sheet flooring such as plywood or particleboard (all profiles)
- Existing strip timber floors (all profiles)

Boral Parquetry

Boral Parquetry is a solid hardwood timber flooring product that is designed to be laid directly over a flat and level concrete slab, plywood or particleboard flooring. It is supplied in blocks 260mm long x 65mm wide x 18mm thick.

Boral Parquetry can be laid in many patterns using contrasting timber species to create depth in design.

Centre “dots” measuring 65mm x 65mm can be individually laid to create various patterns.

Suitable subfloors

Boral Parquetry is designed for any subfloor that is structurally sound, level, flat, clean and dry such as:

- A concrete slab
- Sheet flooring such as plywood

2.2 DECKING

Boral Decking

Boral Decking is a solid hardwood timber product that is designed to be laid outdoors directly onto structural bearers and joists or can be used for fencing, gates or seating.

It is precision milled with round edges to a variety of widths in a smooth finish on both sides of the board.

This installation guide does not apply to speciality applications or commercial decking.

Suitable subfloors

Boral Decking is designed for bearers and joists that are structurally sound as per the Australian Standard AS1720 and the Building Code of Australia:

- Decking should be nailed or screwed directly to hardwood bearers and joists
- When used for fencing it can be screwed into timber or steel posts

3. Product handling on site

The packaging around Boral Timber products is designed to protect it during transport only. Upon delivery timber flooring and decking products should be stored indoors where they can be protected from the elements.

Do not store outside using a protective covering such as a tarpaulin as condensation can occur underneath. Boral Overlay solid strip flooring is delivered in strapped bundles within a pack. It is recommended that the bundles are kept strapped until just before laying.

4. Timber Flooring

4.1 PROPERTIES OF TIMBER

Timber is hygroscopic - meaning it is capable of easily absorbing and expelling moisture in response to local conditions. As timber absorbs moisture it expands and as it expels moisture it contracts. As such, factors such as relative humidity (atmospheric moisture), moisture ingress (subfloor or other), direct sunlight, air conditioning and lack of adequate ventilation can cause timber to expand or contract. Therefore, care must be taken to correctly assess the suitability of the site prior to the installation of timber flooring, as well as to maintain a suitable environment where the timber floor has been installed.

Solid timber flooring may need to be acclimatised to their new local environment before installation. It is important to allow the timber to adapt to the above conditions.

4.2 PRIOR TO INSTALLATION

Before installing a timber floor, ensure the site conditions are suitable. A timber floor should only be installed in a weatherproof building. The project should reach near completion before installation begins to avoid damaging the newly fitted timber floor from heavy trade traffic. The roof, external doors and windows, exterior cladding and wet trades should all be complete before a timber floor is installed. The storm water system must be complete or effectively directed away from the subfloor.

Acclimatisation

Timber is a natural product that expands and contracts with seasonal changes and is affected by the moisture content of the air. The moisture content of timber is the percentage weight of water present in the timber compared to the weight of the timber with all water removed. Moisture content varies with changes in humidity and temperature in the surrounding air.

Small seasonal changes in timber flooring are a normal occurrence and small gaps that open up during dry periods are not considered a defect. To minimise the movement of a hardwood floor caused by swelling on moisture uptake and shrinking on moisture loss, it is important to lay and fix a timber floor that is close to the average moisture content of the environment in which it is to be laid.

This guide outlines the procedures required to assess the site and acclimatise solid hardwood timber flooring for the best results.

Site climate assessment

Every site requires climate assessment prior to the installation of a timber floor. It is important to know the long term relative humidity (RH) for the area where the floor is to be installed. Relative humidity is the major influence determining whether solid timber flooring will absorb moisture from the air and swell, or whether it will lose moisture and shrink.

If the moisture content of the timber floor is close to the average long term relative humidity for the area then subsequent seasonal changes will be minimal. However, if the long term relative humidity for the area is significantly different to that of the timber flooring, seasonal changes in the moisture content of the floor can create problems.

Solid hardwood timber flooring is kiln dried to approximately 9 to 14% moisture content as per Australian Standard AS2796.

See Figure 1.0 on page 4.

Onsite relative humidity is measured with a Hygrometer. It is recommended that Relative Humidity (RH) and temperature levels are recorded prior to and during installation.

The local site climate can be assessed using data from the Australian Bureau of Meteorology website at www.bom.gov.au/climate/averages

Approximate average equilibrium moisture content (EMC) is provided for each climate in Australia. EMC is the moisture content that timber will reach under set conditions of relative humidity and temperature.

Where seasonal variations are greater, seasonal movement (shrinkage and swelling) can be expected to be greater. Areas that experience high levels of seasonal variation require greater allowance for floor expansion at the time of installation.

Adequate subfloor ventilation is an important factor in reducing expansion and cupping of hardwood timber flooring. The sub floor moisture and under floor humidity must comply with BCA and AS 1684 requirements. Where humidity remains high beneath a floor, the boards will absorb the moisture and expand.

Important issues about subfloors

1. The sub floor moisture and under floor humidity must comply to BCA and AS 1684 requirements.
2. Air vents should always remain unobstructed.
3. Number of air vents and size should meet or exceed BCA requirements.
4. Ground level below flooring should be well drained.
5. The subfloor ground should be flat, level and clear of any debris.

It is recommended that the ground below the subfloor be sealed with an impervious membrane, such as 200 micron plastic or vapour barrier. The plastic should be taped continuously with a 200mm overlap.

As subfloor conditions can change, this alone can greatly improve the performance of a timber floor in the future.

Internal micro climates

The internal environment should also be assessed before installation. Within a dwelling, a number of climates may develop, causing areas of flooring to respond differently within the same dwelling.

These include large expanses of glass, fireplaces, fridges, air conditioners, any appliances that vent warm air, the aspect of the house and two-storey construction. All of these can have an effect on the dimensional movement of the boards. When floors are exposed to direct sun through large glassed areas, protection should be considered before, during and after construction. Evaporative coolers add moisture to the air and raise the relative humidity, resulting in moisture contents in the flooring that are higher than under ambient conditions.

The likely movement of a floor after installation should also be a consideration when assessing the site. Small differences in moisture content between boards at the time of manufacture (5% is allowed by Australian Standards) together with variable conditions within the house (such as a west-facing room compared to a south-facing) will cause further variation in board width.

Figure 1.0 – A simple guide to whether acclimatisation is necessary

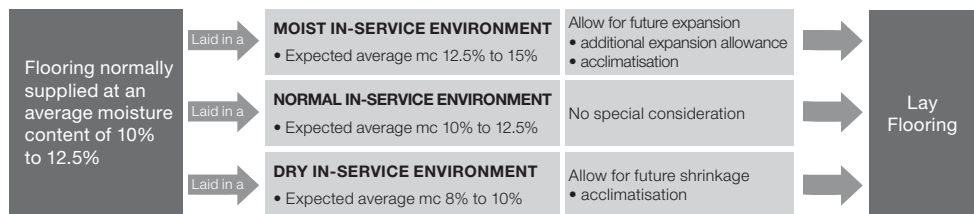

Some of the information regarding acclimatisation has been sourced from the FWPRDC document 'Timber Flooring' version one December 2005

For this reason, it can be expected that small gaps will occur at the edges of most boards, particularly during drier months. These gap sizes may differ across the floor.

In cases where shrinkage may occur after installation, wider solid strip flooring boards such as 130mm will result in larger gaps at board edges when compared with narrower board widths (e.g. 85mm). Air conditioning that does not have a humidity control system, which is installed after a floor has been laid, may increase the size of shrinkage gaps, as it changes the relative humidity in the area.

Some movement occurs after laying timber floors as the timber adjusts to the climate. Although some floor finishes may reduce moisture content changes, they will not prevent this kind of movement. In cases where greater movement is expected after installation, such as from seasonal changes, the use of wider boards or from air conditioning installed after installation, particular care should be taken to ensure that the flooring finish does not act as an adhesive by bonding a number of boards together. With subsequent shrinking, wide gaps between groups of four or five boards may occur, or boards may split.

Installation moisture content and acclimatisation

Solid hardwood timber flooring is kiln dried to 9 to 14% moisture content as per Australian Standard AS2796.

Where the average supplied moisture content of the flooring is near the expected average in-service moisture content, acclimatisation of the hardwood boards is not necessary. Where conditions are drier, such as inland areas or air conditioned buildings, or where conditions are humid, such as in coastal areas or elevated regions, flooring may need to be acclimatised on site.

Acclimatisation is the process of allowing partial equalisation of the moisture content of the hardwood timber flooring when supplied, to the moisture content of the surrounding environment in which the timber is to be installed. Note that the rate of moisture uptake varies from species to species and must be monitored on site for each individual site installation.

Acclimatisation relies on each individual board being exposed to the in-service atmosphere so packs must be opened and re-stacked in a way that allows air to flow freely between each board.

Acclimatisation can only be effective in dry locations during dry periods or in an air conditioned building if the air conditioning is operating at the time.

Acclimatisation is only complete when the moisture content of the timber flooring is equal to the Relative Humidity (RH) in the environment. This usually takes about 14 days for 19mm flooring, but the time may vary depending on the species used and the weather conditions. To check that the timber flooring has reached this point it should be moisture tested with an appropriate timber moisture meter.

This reading can then be compared to the Relative Humidity (RH) using Table 1.1.

Table 1.1 – Moisture content of wood at various temperatures and relative humidity readings

Temperature (°C)	Relative Humidity (percent)			
	40	50	60	70
18	7.8	9.3	11.1	13.2
20	7.7	9.3	11.0	13.1
22	7.7	9.2	10.9	13.1
24	7.6	9.2	10.9	13.0
26	7.6	9.1	10.8	12.9

Boral Overlay solid strip flooring and Boral Parquetry product acclimatisation

Overlay solid strip flooring and parquetry should be acclimatised after installation has been completed. The flooring must be left un-sanded for approximately 14 days before sanding and coating.

In a dry in-service environment this type of acclimatisation may lead to gapping between the boards. If required, these gaps may be “trowel filled” using an appropriate timber flooring putty.

In a moist in-service environment this acclimatisation method should be used with caution and extra expansion gaps will be required to take up the expanding boards.

Inspection of the site, the subfloor surface and preparation

1. Conduct a visual inspection for signs of moisture possibly resulting from pipe leaks, window seal leaks, bathroom/laundry overflow problems, ceilings leaks or rising damp. Any signs of moisture ingress must be remedied prior to installation.
2. The subfloor must be dry and free of contaminants including but not limited to oil, paint, grease, dust, metal shavings, saw dust.
3. Fully scrape the subfloor with a wide blade scraper to remove all cement render spoil, plasterboard setting residues and mortar excess at the base of walls.
4. Make sure the concrete slab is flat with no more than +/-3mm deviation in a 3 metre radius as per Australian Standard AS3600 - 2001: Concrete structures. Deviations to the surface greater than 3mm over 3m are to be filled with a self levelling compound following manufacturers recommendations, or ground down to conform to the aforementioned specification for flatness. *Note: When installing timber flooring over battens, unevenness in the subfloor can be remedied through the use of packers or by planing down the battens.*

5. A concrete subfloor should be moisture tested in accordance with AS1884 - 1985 to ensure the concrete subfloor has a moisture content (“MC”) of less than 5.5%. If the MC is greater than 5.5%, a moisture/vapour barrier must be applied as per the manufacturer’s recommendations. It is also recommended to provide a 200 micron plastic membrane (builders plastic) as a moisture/vapour barrier prior to installation of the battens or plywood substrate. This minimises the risk of moisture uptake into the timber flooring from the concrete slab after installation. The plastic barrier should continue 75mm up the walls and all joints should overlap by 200mm. Joints should then be sealed with duct tape.

Install the moisture/vapour barrier as per manufacturers instructions. Ensure a compatible adhesive is used with the moisture/vapour barrier.

6. Timber substrates such as particleboard, plywood or existing timber floors should be sanded to create a clean flat surface. If plywood is used it must comply with AS/NZS 2269 – Part 0 Plywood Structural Specifications.
7. If installing timber flooring over bearers and joists or a platform floor it is particularly important to maintain adequate sub-floor ventilation. If the area underneath the timber flooring is consistently damp (high humidity) this can adversely affect the timber flooring and lead to increased expansion and/or cupping. Subfloor ventilation should at a minimum conform to the Building Code of Australia, although in areas of high humidity or where increased exposure to moisture is apparent it is good practice to increase the surface area of the vents and/or install fans to increase air circulation under the floor. Subfloor vents should always allow for cross ventilation of the subfloor and must not be placed on only one side of a dwelling.

4.3 INSTALLATION

Please check all material for faults or defects prior to installation.

Boards need to be mixed on the floor according to colour and feature. This is at the discretion of the installer. If there are any problems before or during the laying of a Boral Timber product, stop and do not continue laying. Contact Boral Timber immediately on 1800 818 317 or email timberspec@boral.com.au for further advice.

Expansion gaps (control joints)

Plan expansion gaps and perimeter fixings before commencing the job. Due to the hygroscopic nature of timber, the flooring will expand and contract with changes in moisture content making expansion gaps essential. The allowance of expansion gaps at the perimeter walls and around obstructions will allow the floor to move as required. Insufficient expansion gaps can result in buckling and deformation of the flooring.

Boral Timber recommends a minimum expansion gap at all perimeter walls and obstructions of 12mm.

For domestic applications floor widths over 6m will require an intermediate expansion joint as per Australian Standard AS1684. Where extra allowance for expansion is required (e.g. moist locations), cramping pressure needs to be considered. Alternatively, a series of smaller expansion gaps every 800mm to 1000mm can be used to provide equivalent spacing. If cork expansion joints are used, the cork should be approximately 2mm above the floor surface when installed. This will be removed during the sanding process. However, cork to the perimeter should be installed level with the timber surface. Expansion gaps can be readily increased by under cutting plasterboard walls or through the use of thicker skirtings or beading. Overall, the greater the expansion allowed while installing, the better.

Expansion joints are best placed at doorways or in line with internal walls. Expansion joints help to break large floors into smaller sections thereby maximising total expansion gaps.

Refer Diagram 1.0.

Specialty Applications

For specialty applications, such as sports floors and some commercial applications, additional expansion gaps may be required and should be assessed on a site by site basis.

Diagram 1.0

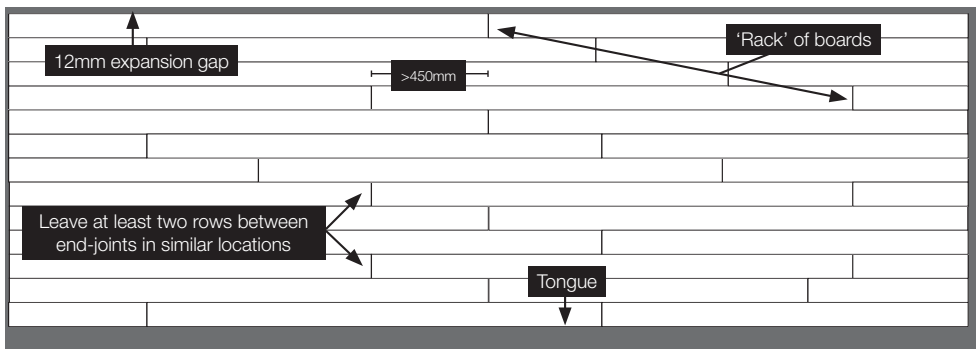

Underlay systems

There are a variety of acoustic systems available on the market today. Boral Timber recommends Boral RV4 acoustic underlay for use with its solid timber flooring products.

Boral RV-4 is well suited to reducing the noise of foot traffic in multi-level apartments and exceeds the BCA requirement of L_{nw}+C of 62 for acoustic underlays for solid timber flooring. The product system is deemed to comply in accordance with ISO 140.6 and 140.8 as defined in AS ISO 717.2 – 2004.

Please request full installation instructions on installing Boral RV4 underlay with a Boral timber flooring product prior to installation. For further details contact Boral Timber on 1800 818317.

4.3.1 – 19MM SOLID STRIP FLOORING INSTALLATION

Subfloor preparation

180mm boards should be face (top) nailed in accordance with AS 1684.2. Ensure subfloor preparation recommendations are followed as per page 4 in this guide.

Battens or plywood

Battens may be used to compensate for minor fluctuations in concrete level. For secret nailing, use 19mm battens and for top nailing use battens that are at least 35mm thick. Lay battens 450mm apart on the plastic membrane at right angles to the direction of the new floor. Adjust levels with plywood or masonite packing and use masonry anchors to attach battens to the slab.

For the best result, Boral Timber recommends the use of kiln dried hardwood battens to give the highest possible nail hold.

An alternative method is to fix plywood sheeting (recommended minimum thickness of 15mm or greater) to the concrete slab after first laying a polyethylene membrane (minimum 200 micron). For this application top nailing is not suitable. Plywood must comply with AS/NZS 2269 - Part 0 Plywood Structural Specifications.

Bearers and joists

Existing joists should be inspected for structural soundness prior to installation of new timber flooring. Ensure there is sufficient subfloor ventilation and clearance between the ground and flooring. The subfloor ventilation and clearance should meet or exceed BCA requirements. Air should circulate below the new floor from all four sides of the house.

The level of the floor frame must be suitable for the installation of the strip flooring, ascertaining the suitability is the responsibility of the builder or floor contractor. A number of alternative methods exist to assess the floor frame.

The method most commonly used is to place a straight edge of a minimum of 3 metres on top of the joists and assess the various high and low members. The joists can be planed down if too high or packed if too low. Care must be taken to ensure that the joists are not reduced in sectional size below that required under AS1684. This same structural requirement prevails in cases where the joists are “crippled” i.e. cut through over a support to reduce the bow in the timber.

Existing timber flooring

When laying a Boral 19mm solid strip floor over existing timber floors make sure the existing boards are sound and not warped or cupped. Sand for an even surface if necessary. If the existing boards are very uneven, remove the entire floor and lay the new boards directly over the joists. The new Boral 19mm solid strip floorboards may be glued using a polyurethane flooring adhesive and nailed at 90° to the boards. To run the new timber floor boards in the same direction as the current timber floor boards, a plywood layer is required between the new and existing floor boards. The plywood must comply with AS/NZS 2269 - Part 0 Plywood Structural Specifications.

Laying the boards

Sort the timber into two stacks: one of similar-length boards and one of varying lengths. Start by laying the varying lengths, longest first, in a triangle or “rack” from one corner. Lay first board with groove towards the wall and leave a 12mm expansion gap all round the room between the floor and the wall (not the skirting, if any). This gap will be covered by the skirting. Retain the existing skirting if the new board can slide under it. If not, remove the skirting. Continue each row by laying the similar-length boards in each row, adding and cutting short lengths to finish the row (still leaving a 12mm gap). There must be at least 450mm distance between butt joints in adjacent rows.

Refer Diagram 1.0 on page 7.

Distribute end-joints evenly

Plain end boards must be joined on a joist, except with end matched boards. Make sure all joints are distributed evenly and do not cluster in any one section of the floor. Push end matched boards together before using a tapping block to avoid damage to the tongues.

Nailing the boards

Once acclimatised correctly, secret-nail boards permanently to the joists or battens with a secret-nailing gun, or cramp them and top-nail with a traditional hammer or standard nail-gun. A secret-nailing gun will “kick” the boards together at the same time as it drives the nail in at 45°. When installing over an existing floor or on a plywood base also use a polyurethane flooring adhesive as per manufacturer’s instructions. If nailing into plywood, nailing should be on every joist or at 450mm centres and alternate to the bead of polyurethane flooring adhesive, as per manufacturers instructions, between nail centres.

If top-nailing the floor directly onto joists, attach floor-cramps to a few joists to lever the strips together evenly across the room. Floor-cramps may be hired from a reputable tool hire firm. Cramp nine or ten boards at one time - do not cramp two or three strips together as this may set up excessive strains in the floor causing over-cramping.

Recommended nails

As a minimum requirement for secret-nailing use 45mm-long Powernail cleats or equivalent size nail/staple as specified in AS1684. For machine driven top-nailing use 2.2 to 2.5mm finish-heads, 45mm long (2.5 times the timber thickness), 2 per joist. Scribe and cut the last board to the profile of the wall and tighten up by hand, or lever with a chisel.

180mm boards should be face (top) nailed in accordance with AS 1684.2. Contact Boral Timber for further information.

Sanding and finishing

There are many different types of finishes available from oils through to water based polyurethanes. Choose the best finish to suit the functional and aesthetic requirements of the job. It is important that the manufacturer’s instructions are followed carefully.

Do not use a product that will bond several boards together. This can create unsightly gaps as the boards expand and contract in groups, creating large gaps every four to six boards. Always check with the finish manufacturer that this is not a problem. Allow a curing period as per manufacturer’s instructions after completing the fixing of the floor before sanding, to allow the glue time to set. Boral Timber recommends the use of a professional sander and finisher to complete the sanding and finish stage of the job. Refer to AS4786 for sanding and finishing of timber floors.

Framing the floor

The 12mm expansion gap left between the wall and the floorboards will need to be covered. This can be covered with an appropriate skirting which should be nailed to the wall and not fixed to the floor. If the timber flooring is installed with existing skirtings in place use a fillet mould or bead to cover the gap, fixed to the skirting and not the floor.

Secret fixing wide boards

The following procedure is for secret fixing 108mm and 130mm Boral solid strip flooring by using a combination of flooring cleats and full trowel adhesive to attach the hardwood flooring to a solid sheet subfloor.

This procedure should be used as a guideline for wide board secret fixing. Secret fixing wide board flooring requires skilled tradespeople, who understand the potential hazards of incorrect installation, and should not be undertaken by novice flooring installers.

Acclimatisation

Correct acclimatisation is critical for a successful installation. Knowledge of site conditions, both currently and in the future, are important for secret fixing wide flooring.

For the best results secret fixing of wide boards should be undertaken where the seasonal moisture content change is limited to a 4% point swing, for example 9% - 13%. Onsite testing and research into the anticipated moisture swings should be undertaken to confirm that the site is suitable.

Refer to page 3 for further details on how to acclimatise timber flooring correctly.

Subfloor

The following subfloors are suitable for secret fixing wide board flooring:

- 15mm (or greater) plywood (must comply with AS/NZS 2269 – Part 0 Plywood Structural Specifications)
- 19mm (or greater) particleboard flooring

The plywood or particleboard subfloor must have a moisture content that is within 2% of the acclimatised timber flooring being installed.

Note that secret fixing wide board flooring directly to floor joists is not recommended.

Subfloor requirements

Plywood/particleboard on bearers and joist system

It is important to ensure adequate cross-flow ventilation in the area below the flooring. Observe the following recommendations:

1. Air vents should always remain unobstructed.
2. The number of air vents and size should equal or exceed BCA requirements.
3. The ground level below the flooring should be flat, well drained and clear of any debris.
4. The subfloor ground must be dry at the time of installation and should remain dry.

It is also recommended that the ground below the subfloor be covered with an impervious membrane, such as 200 micron plastic. The plastic should be taped with a 200mm overlap.

Plywood fixed to concrete

Ensure the concrete slab is flat with no more than +/- 3mm deviation in 3 metres as per Australian Standard AS3600 – 2001: Concrete structures. A self-levelling compound can be used to level any variations. The moisture content of the slab must be 5.5% or below.

If the moisture content of a new slab is too high, installation of the floor will need to wait until moisture content decreases to 5.5% or less.

Lay a 200 micron plastic membrane over the whole area and continue up the walls 75mm (to be trimmed later). Overlap joins by 200mm and seal the entire join with duct tape.

Plywood is then fixed on top of the plastic membrane as per manufacturers instructions.

Table 2.0 - Blackbutt Expected moisture content

uptake or loss following installation

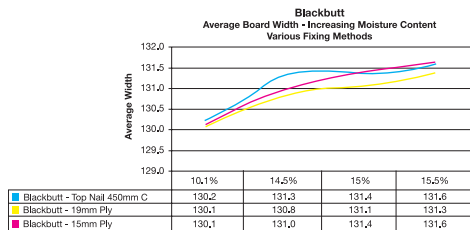

Source - Boral Timber Independent test report March 2007

Table 2.1 - Spotted Gum Expected moisture content

uptake or loss following installation

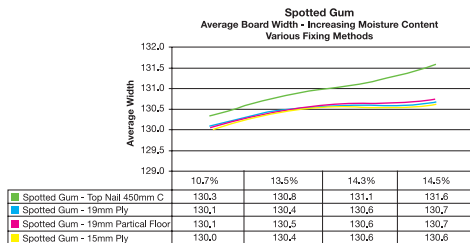

Source - Boral Timber Independent test report March 2007

Table 2.2 - Expected moisture content uptake or loss following installation

	0.0%	1.0%	2.0%	3.0%	4.0%	5.0%
Visual Appearance	No movement	Very small amounts of movement	Small amounts of movement	Noticeable gapping/Slight cupping	Medium gaps and/or cupping	Large (approx. 2mm) gapping and/or cupping
Install method - Structural integrity	Suitability					
Top nail 450mm centres into joists	Suitable	Suitable	Suitable	Suitable	Suitable	Suitable
Secret nail at 300mm centres on 15mm ply - full trowel adhesive	Suitable	Suitable	Suitable	Suitable	Not Suitable	Not Suitable
Secret nail at 300mm centres on 19mm plywood/particle board - full trowel adhesive	Suitable	Suitable	Suitable	Suitable	Suitable	Not Suitable

Independent testing

Boral Timber has undertaken independent testing on various different installation methods and has found the recommended method to be the most stable.

Testing has shown that the recommended fixing method offers equal to/or greater restraint than the current recommendation of two top nails every 450mm.

As for all fixing methods, secret nailing wide board will not suit all installation situations, particularly sites where large moisture fluctuations are expected.

Installation procedure

Laying the boards

Sort the timber into two stacks: one of similar-length boards and one of varying lengths. Start by laying the varying lengths, longest first, in a triangle or “rack” from one corner. Lay the first board with its groove towards the wall and leave a 12mm expansion gap all round the room between the floor and the wall (not the skirting, if any). This gap will be covered by the skirting. Retain existing skirting if the new board can slide under it. If not, remove the skirting. Continue each row by laying the similar-length boards in each row, adding and cutting short lengths to finish the row (still leaving a 12mm gap). There must be at least 450mm distance between butt joints in adjacent rows.

1. Fully trowel out a workable area (approximately 3 -5m2) of polyurethane flooring adhesive, as per manufacturers instructions, onto the subfloor. A workable area is governed by the conditions that you are working in. The adhesive should not dry or “skin over” before adhesion occurs.
2. Place boards onto the adhesive with minimal disturbance to the glue.
3. Secret nail floor boards permanently to the subfloor with a Powernail secret-nailing gun (Powernail 445, 45R).

4. Use 38mm Powercleats when fixing to 15mm plywood and 44mm Powercleats for 19mm particleboard or plywood. The secret-nailing gun will “kick” the boards together at the same time as it drives the nail in at 45 degrees.
5. Secret nail at 250mm to 300mm centres into the subfloor and no further away than 50mm from an end joint.

Limitations

Excessive swings in humidity and subsequently higher movement in moisture content will result in larger gaps or cupping in the floor – see [Table 2.2 on page 11](#) for what can be expected as the variation becomes larger.

Key points for successful secret fixing installation of wide boards

- Secret fixing of wide board flooring should only be undertaken by a competent timber flooring installer with an understanding of the relationship between timber and its surrounding environment.
- Understand, test and record the moisture content of the subfloor, timber flooring and the area to be installed and assess the suitability of the site.
- All moisture readings and test results pertaining to the site must be recorded and permanently retained for future reference.
- Do not install a wide board floor using secret fixing if the moisture swing is expected to exceed four percentage points from the moisture content of the timber at the time of installation.
- Fully trowel polyurethane flooring adhesive, as per manufacturers instructions.
- Ensure that nail centres are 250 -300mm apart and no more than 50mm from an end.
- It is normal to expect that timber floor gapping may occur through seasonal change.

Sanding and finishing

[See page 9](#) for sanding and finishing information.

4.3.2 OVERLAY SOLID STRIP FLOORING INSTALLATION

Boral Overlay solid strip flooring includes 80mm x 10mm, 80mm x 13mm and 130mm x 14mm wide board profile. The wear layer (the larger dimension) is towards the top of the board. Boral Overlay is delivered in strapped bundles. It is recommended that the bundles are kept strapped until just before laying.

Subfloor preparation

Boral Overlay is designed for a subfloor that is structurally sound, level, flat, clean and dry such as:

- Concrete slab (80mm x 10mm, 80mm x 13mm only).
- Sheet flooring such as plywood or particleboard (all profiles)
- Existing strip timber floors (all profiles)

Please ensure subfloor preparation recommendations are followed as [per page 6 in this guide](#).

Glue Down Application for 10mm and 13mm

In all cases, the subfloor must be structurally sound, level, flat, dry and clean.

Existing Plywood/Sheet Flooring

Plywood or particleboard is a good subfloor for Boral Overlay when free from wax and dirt. The subfloor must be level sanded prior to installation. This will remove any other surface irregularities, such as edge swelling at joints.

Plywood sheeting should be a minimum of five ply 12mm thick. The plywood sheeting must comply with AS/NZS 2269 – Part 0 Plywood Structural Specifications.

Existing timber floor

Existing timber flooring must be rough-sanded to remove any unevenness, cupping or rough material and to remove wax or other surface finishes. It is recommended that the Boral Overlay boards be laid at a 90 degree angle to the line of the subfloor boards to avoid possible subfloor movement that could affect the finished floor. If the above preparation is not practical then plywood sheeting should be laid over the existing floor boards to act as a subfloor. To run the new timber floor boards in the same direction as current timber floor boards, plywood is required between the new and existing floor boards. The plywood sheeting must comply with AS/NZS 2269 – Part 0 Plywood Structural Specifications.

Direct stick to Concrete slab

This procedure should only be used for installing 10mm and 13mm Boral Overlay flooring. Wide board 14mm cannot be laid directly over concrete slabs.

- The concrete must be sound and have a steel trowelled finish and be free of floating ridges. These may be removed by rubbing the floor with an emery stone or house brick.
- The concrete should be clean, dry and free of contaminants including, but not limited to, dust, wax, coatings, adhesives, curing compounds, oil or grease. The slab must be flat with no more than +/- 3mm deviation in a 3m radius as per Australian Standard AS360 – 2001: Concrete structures. If deviations are greater than acceptable then the laying surface can be made level by using a self-levelling compound.
- Concrete floors that are not suspended should have a polyethylene waterproof membrane underneath to prevent rising damp. If this is not present or there are concerns with varying moisture in the slab, a moisture/vapour barrier should be used as per the manufacturer's instructions. Ensure a compatible adhesive is used with the moisture/vapour barrier.

- An alternative method is to fix plywood sheeting to the concrete slab after first laying a polyethylene membrane (minimum 200 micron). The plywood sheeting must comply with AS/NZS 2269 – Part 0 Plywood Structural Specifications.
- Boral Overlay must not be laid on any section of a concrete floor which has moisture content of more than 5.5%. The best way to test for moisture content is to use an appropriate moisture meter.

Installation

- Lay the boards parallel to the longest wall in the room.
- Set up a work area and a main floor area. Flick a chalk line that is 10 board widths plus 12mm from the starting wall to establish a straight line. The area between the chalk line and the starting wall is the work area.
See Figure 1.
- Using concrete nails or "mickey pins" nail a row of boards on this line as a holding block, with the tongue facing the starting wall. The nails may be removed after the glue has set. Pneumatically fixed 'T' nails are acceptable as alternative to 'mickey pins'.
- Leave a 12mm expansion gap along end walls. Place 12mm blocks/wedges along one end to maintain the gap while boards are being placed and glued down.

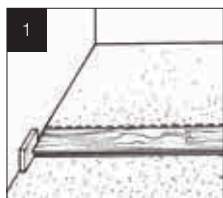

- Boral Overlay must be fixed with a flexible polyurethane flooring adhesive. The use of ridged and semi ridged adhesives is not recommended by boral timber. The adhesive should be applied as per manufacturers guidelines. Fully trowel with adhesive using a 5mm V notch trowel and spread only enough for 3 or 4 boards at a time as per manufacturers instructions.
- Once laid the boards should be in constant, firm contact with the adhesive until cured. If in doubt, nail down (using “mickey pins” or similar, which can be removed later) or apply weights. Do not remove weights or “mickey pins” until the adhesive is completely set.

Start the first row of boards with the tongue facing the starting wall and the left hand end of the board against the block/wedge on the side wall. Slot the tongue firmly into the groove on the fixed temporary board and then press the board down firmly into the adhesive. *See Figure 2.*

- Working from left to right, lay the next board and continue working towards the right then measure and cut a strip to finish the first row, remembering to allow for a 12mm expansion joint.
- To minimise cutting waste try to make the off-cut from this board long enough to use elsewhere.

As the next row is added, tap the boards gently together using a tapping block for a tight fit. *See Figure 3.*

- Use of straps (dogging) can cause over cramping and affect the contact between adhesive and the boards.
- The frequency and use must ensure constant contact between the floor and the boards during the curing process of the adhesive as per the manufacturer's instructions.
- Use a pull tool to fit the last board closest to the wall.

Start all new rows with a board at least 300mm shorter or longer than the strip used in the previous row. This will prevent end joints from clustering or aligning throughout the floor.

See Figure 4.

- Scribe the last board to fit allowing for the 12mm expansion joint along its whole length.
- Once the main floor area has been laid, remove the temporary block and lay Boral Overlay in the work area, following the procedure above.
- Clean up excess adhesive as per manufacturer's instructions.
- Following installation, vacuum thoroughly and clean the floor.

Nail/staple Down Application for 10mm and 13mm

In all cases, the subfloor must be structurally sound, level, dry and clean.

Plywood

Plywood or particleboard is a good subfloor for Boral Overlay when free from wax and dirt. The subfloor must be level sanded prior to installation removing any surface irregularities, such as edge swelling at joints. Plywood sheeting should be a minimum of five ply 12mm thick.

The plywood must comply with AS/NZS 2269 – Part 0 Plywood Structural Specifications.

A plastic moisture barrier (minimum thickness of 200 micron) needs to be installed under the plywood as per manufacturer's instructions. Any joints should be overlapped by 200mm and taped to ensure that no moisture ingress (entry) is possible through the barrier. An alternative, is to apply a moisture/vapour barrier as per manufacturers instructions. Ensure a compatible adhesive is used with the moisture/vapour barrier.

Existing Timber floor

Existing timber flooring must be rough-sanded to remove any unevenness, cupping or rough material and to remove wax or other surface finishes. It is recommended that the Boral Overlay solid strip floor boards be laid at a 90 degree angle to the line of the existing subfloor boards to avoid possible subfloor movement that could affect the finished floor. If the above preparation is not practical then plywood sheeting should be laid over the existing floor boards to act as a subfloor. If plywood is used it must comply with AS/NZS 2269 - Part 0 Plywood Structural Specifications.

Installation

- Lay the boards parallel to the longest wall in the room.

Leave a 12mm expansion gap along side and end walls. Place 12mm blocks/wedges along sides and on one end to maintain these gaps while boards are being placed and nailed or

Figures A-D

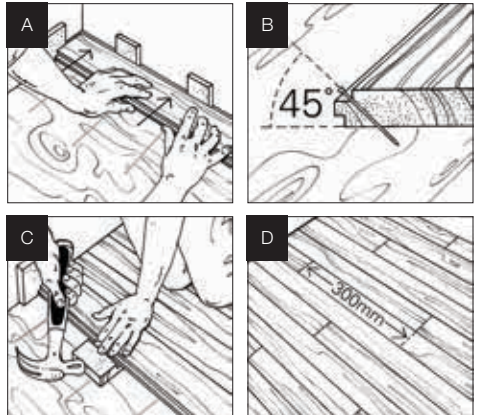

- Boral Overlay must be fixed with a polyurethane flooring adhesive as per manufacturers instructions. Fully trowel with adhesive using a 5mm V notch trowel and spread only enough for 3 or 4 boards at a time as per manufacturers.

Starting from the wall and working from left to right, lay the boards and nail *as per Figure B* with the groove to the wall.

- Continue working towards the right then start the next row, remembering to allow for a 12mm expansion joint. To minimise cutting waste try to make the off-cut from this board long enough to use elsewhere.
- All rows except those immediately adjacent to a wall should be nailed using a Powernailer model 50C, 50P or 50M. Due to the obstruction created by the wall the boards adjacent to the wall will need to be hand/top nailed and counter sunk.
- Apply a 5mm bead of recommended polyurethane flooring adhesive every 150 - 200mm, alternating between nails. Nail every 150 - 200mm and at least 50mm from each end joint.

As the next rows are added, tap the boards gently together for a tight fit. *See Figure C.*

- Use a pull tool to fit the last board, closest to the wall.

Start all new rows with a board at least 300mm shorter or longer than the strip used in the previous row. This will stop end joints from clustering throughout the floor. *See Figure D.*

- It is recommended that a chalk line is flicked every metre (or as required), parallel to the starting wall to ensure that the Boral Overlay solid strip floor remains square.
- Scribe the last board to fit, allowing for a 12mm expansion joint along the whole length.
- Clean up any excess adhesive as per manufacturer's instructions.
- Following installation, vacuum thoroughly and clean the floor.

Sanding and finishing

Refer to page 9 for sanding and finishing information installing 130mmx14mm overlay.

Installing 130mmx14mm Overlay

In all cases, the subfloor must be structurally sound, level, flat, dry and clean. Boral Overlay is suitable to be installed over plywood, particleboard or existing timber flooring. Wide board 130mmx14mm cannot be laid directly over Concrete slabs.

Plywood/particleboard

Plywood or particleboard is a good subfloor for Boral Overlay when free from wax and dirt. The subfloor must be level sanded prior to installation removing any surface irregularities, such as edge swelling at joints. Plywood sheeting should be a minimum of five ply 12mm thick.

The plywood must comply with AS/NZS 2269 - Part 0 Plywood Structural Specifications. The plywood or particleboard should have a moisture content that is within 2% of the flooring being installed.

If installing plywood/sheet flooring over a concrete slab, a plastic moisture barrier (minimum thickness of 200 micron) needs to be installed under the plywood as per manufacturer's instructions.

Any joins should be overlapped by 200mm and taped to ensure that no moisture ingress (entry) is possible through the barrier. An alternative, is to apply a moisture/vapour barrier as per manufacturers instructions. Ensure a compatible adhesive is used with the moisture/vapour barrier.

Existing Timber floor

Existing timber flooring must be rough-sanded to remove any unevenness, cupping or rough material and to remove wax or other surface finishes. It is recommended that the Boral Overlay solid strip floor boards be laid at a 90 degree angle to the line of the existing subfloor boards to avoid possible subfloor movement that could affect the finished floor.

If the above preparation is not practical then plywood sheeting should be laid over the existing floor boards to act as a subfloor.

If plywood is used it must comply with AS/NZS 2269 – Part 0 Plywood Structural Specifications.

Installation of 130mmx14mm wide board

Boral Overlay 130mm x 14mm must be installed using a full trowel glue and mechanical fix method.

- Lay the boards parallel to the longest wall in the room. Leave a 12mm expansion gap along side and end walls. Place 12mm blocks/wedges along sides and on one end to maintain these gaps while boards are being placed and nailed or stapled. *See Figure A.*
- Boral Overlay must be fixed with a polyurethane flooring adhesive as per manufacturers instructions. The subfloor area must be fully trowelled with adhesive. Spread only enough for 3 or 4 boards at a time. Starting from the wall and working from left to right, lay the boards and nail *as per Figure B* with the groove to the wall.
- Continue working towards the right then start the next row, remembering to allow for a 12mm expansion joint. To minimise cutting waste try to make the off-cut from this board long enough to use elsewhere.

- All rows except those immediately adjacent to a wall should be nailed using a Powernailer model 50C, 50P or 50M. Due to the obstruction created by the wall the boards adjacent to the wall will need to be hand/top nailed and counter sunk.
 - 19mm power cleats should be used if installing overlay over 12mm plywood sub floor. 25mm power cleats should be used if installing overlay a 19mm particle board sub floor.
 - Nail every 150-200mm and at least 50mm from board ends. As the next rows are added, tap the boards gently together for a tight fit. *See Figure C.*
 - Use a pull tool to fit the last board, closest to the wall. Start all new rows with a board at least 300mm shorter or longer than the strip used in the previous row. This will stop end joints from clustering throughout the floor. *See Figure D.*
 - It is recommended that a chalk line is flicked every metre (or as required), parallel to the starting wall to ensure that the Boral Overlay solid strip floor remains square.
 - Scribe the last board to fit, allowing for a 12mm expansion joint along the whole length.
 - Clean up any excess adhesive as per manufacturer's instructions.
 - Following installation, vacuum thoroughly and clean the floor.
- ridges. These may be removed by rubbing the floor with an emery stone or house brick.
- The concrete should be clean, dry and free of but not limited to dust, wax, coatings, adhesives, curing compounds, oil or grease.
 - The slab must be flat with no more than +/- 3mm deviation in a 3 metre radius as per Australian Standard AS3600 – 2001: Concrete structures. If the deviations are greater than acceptable then the laying surface can be brought to level by using a self-levelling compound.
 - An alternative method is to fix plywood sheeting to the concrete slab after first laying a polyethylene membrane (minimum 200 micron). The plywood sheeting must comply with AS/NZS 2269 – Part 0 Plywood Structural Specifications.
 - Parquetry must not be laid on any section of a concrete floor which has moisture content of more than 5.5%. The best way to test for moisture content is to use an appropriate moisture meter.
 - Concrete floors that are not suspended should have a polyethylene waterproof membrane underneath to prevent rising damp. If this is not present or you have concerns with varying moisture in the slab, you should use a moisture/vapour barrier as per the manufacturer's instructions. Ensure a compatible adhesive is used with the moisture/vapour barrier.

Sanding and finishing

Refer to page 9 for sanding and finishing Information.

4.3.3 BLOCK PARQUETRY INSTALLATION

Subfloor preparation

Please ensure subfloor preparation recommendations are followed as per *page 8* in this guide and the instructions for acclimatisation as per *page 3*.

Concrete slab

- The concrete must be sound and have a steel trowelled finish and be free of floating

Plywood

The subfloor must be level sanded prior to Boral Parquetry installation. This will remove any other surface irregularities, such as edge swelling at joints. The Plywood must comply with AS/NZS 2269 – Part 0 Plywood Structural Specifications.

Setting out

Find the centre of the room and strike chalk lines parallel to the walls. *See Diagram 4.0.* Ensure that the lines intersect at right angles. If the room is not square, find the centre point of the room by snapping a chalk line at the centre of A and B as well as C and D. *See Diagram 4.1.*

Measure right angle triangle 3 (900mm) and 4 (1200mm) and 5 (1500mm). Check the length of 5. If 5 is not the correct length adjust line C and D until correct.

This is very important for correct placement of the pattern.

- Lay off the parquetry to the perimeter and leave even cutting on all sides.
- Leave a 12mm expansion gap at the perimeter.

Diagram 4.0

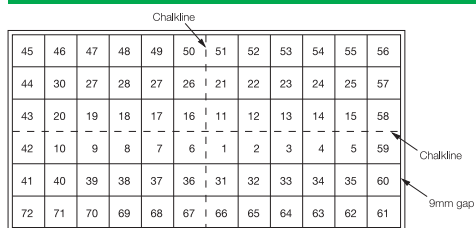

- If a border is to be laid, snap chalk lines the width of the border plus 12mm from the perimeter. Do not glue past this line when laying the body of the floor. Where the parquetry blocks extend past the glue area place the whole block (without extra glue) and trim later as described below.
- 24 hours after laying re-mark the border lines and setting the saw depth to the thickness of the block, cut out the border. Lay the border leaving a 12mm expansion gap.

Laying the product

Pour a quantity of recommended parquetry adhesive onto the floor at the centre of the room and using a parquetry spreader vigorously comb onto the floor leaving ridges of adhesive the full depth of the spreader teeth (Figure 1). Sufficient adhesive for one square metre should be spread at a time. Select a number of parquetry blocks from various boxes (to ensure colours are mixed) and lay into the spread adhesive. Ensure the block has made good contact with the adhesive by sliding it into place. Keep the edge of the panel exactly to the chalk lines and continue laying blocks in the sequence shown keeping

them tightly together (Figure 2). Regularly tap the parquetry in the adhesive bed with a rubber mallet or timber block (Figure 3). Continue until the whole room is covered. Cut the last blocks with a handsaw or small circular saw leaving 12mm clearance from the walls.

Diagram 4.1

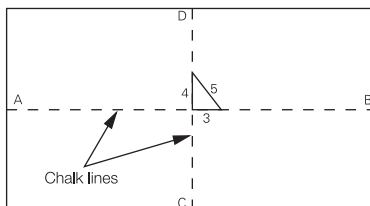

This expansion space can be covered later by skirting boards, beading or quarter round. At doorways the parquetry can be cut neatly to door jambs and architraves. Where parquetry meets adjoining solid floors such as stone or concrete, the expansion gap should be filled with a strip of cork or covered by a fillet moulding.

Sanding and finishing

Refer to page 9 for sanding and finishing information.

Figures 1 - 3

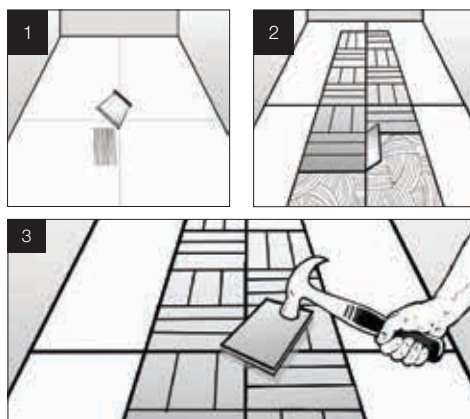

4.4 IMPORTANT POINTS TO REMEMBER

With the abundance of various different primers, levelling compounds, sealers and adhesives on the market, the following points should be considered and applied. Always follow the manufacturer's guidelines.

- Always use compatible products. Manufacturers often have recommended "systems" that guarantee compatibility.
- If a border is to be laid, snap chalk lines the width of the border plus 12mm from the perimeter. Do not glue past this line when laying the body of the floor. Where the parquetry blocks extend past the glue area place the whole block (without extra glue) and trim later as described below.
- 24 hours after laying re-mark the border lines and setting the saw depth to the thickness of the block, cut out the border. Lay the border leaving a 12mm expansion gap.

4.5 POST INSTALLATION CARE AND MAINTENANCE

- Use dirt-trapping mats at all external doorways to reduce the amount of stones, grit and sand entering the area.

- Sweep or vacuum your floor regularly to remove dirt and grit. Sweep using an electrostatic mop.
- Floors should be damp mopped, with a well wrung out mop, to remove dust. Never wet mop or steam mop a timber floor.
- Felt protectors should always be fixed under furniture to prevent scratching.
- Protect timber floors from direct sunlight with appropriate window treatments. Failure to do so may result in localised cupping and or checking of the timber.
- Monitor climatic conditions, extreme climatic conditions may require increasing humidity using a humidifier, or decreasing humidity using an air conditioner. This is especially relevant during periods of non-habitation when there is little or no air circulation within a property. If the residence is expected to be uninhabited for extended periods, care should be taken to control the climate with the use of air conditioning and/or humidity controls.
- For further information on care and maintenance of a timber floor download a Boral Timber Care and Maintenance brochure at www.boral.com.au/timberflooring.

5. Decking

5.1 INTRODUCTION

This guide outlines the installation of timber decking onto bearers and joists. To ensure regulations are met for post sizes, stress grades, bearers and joists spans and other structural elements pertaining to building a deck refer to Australian Standards AS1684: Residential Timber-Framed Construction and AS1720: Timber Structures – Design Methods.

All building codes and Australian Standards need to be adhered to when building a deck including bearers and joists. Check with a licensed builder, architect or engineer before building a deck.

This installation guide does not apply to speciality applications or commercial decking. For specification and design of commercial or industrial applications refer to AS1170: Dead and Live Loads and Load Combinations.

Building a deck in bush-fire prone areas may require adherence to Australian Standard AS3959: Construction of Buildings in Bush Fire Prone Areas.

Check with the local council about relevant regulations. Detailed plans, as well as development and building approvals may be required depending on the scope of the deck.

Boral Decking is seasoned to the moisture requirements of Australian Standard AS2796 (i.e. hardwood 10% to 15%).

Traditional indoor tongue and groove flooring must not be used for weather exposed decks.

5.2 PRIOR TO INSTALLATION

Preparation is important. Determine the dimensions of the deck and note the position of features such as stairs, drains, and gas pipes – these will need to be marked up before any work begins.

Ensure the ground is clear and weed control is undertaken prior to installing the deck.

Land preparation is required by laying drainage to avoid build up of water underneath the deck. Unobstructed air flow is required below the deck. Add vents at various locations for decks with limited ventilation.

Joist span recommendations

- Residential Installation – a 450mm centre to centre joist span
- Commercial installation – a 300mm centre to centre joist span
- 45° angles installation – 300mm centre to centre joist span

5.3 INSTALLING BORAL DECKING

Decking may be left to weather or coated and sealed. When applying coatings or sealants ensure manufacturers instructions are followed.

For decks less than 400mm from or on the ground, ensure the following:

- adequate ventilation
- good surface drainage
- use termite resistant species
- access for maintenance or termite control

To compensate for expansion, boards must be properly spaced during installation. For boards up to 86mm use a spacer approximately 3mm thick to ensure that the decking boards are spaced with 3mm gaps. Allow a minimum

5mm gap between boards for decking boards over 86mm. For residential decking less than 400mm from or on the ground a minimum spacing of 8mm is required.

When fixing joints stagger the joints so they do not sit on adjoining joists to avoid joists splitting. Make sure that all joins in the boards sit over a joist (*Diagram 5.0*). To obtain a tight fit on the joints a slight undercut will assist with the boards sitting flush (*Diagram 6.0*). Pre-drill nail holes (80% of nail diameter) into the board to avoid splitting. Nails must be kept 12mm from edges and ends of boards (*Diagram 6.0*). Nails must be driven flush with surface (not punched).

Each board should be nailed to each joist with two nails as required by Australian Standard AS1684 for required fixings for domestic decking.

Alternatively, proprietary fixings may be used in accordance with manufacturer's instructions.

Only hot dipped galvanised or stainless steel (not plain steel or zinc plated) nails should be used to fix decking to joists.

Stainless steel or silicon bronze fixings are recommended for decks built within 1m of water such as pools, ponds etc

At intermediate fixings, nails should either be offset or driven at slightly opposing angles (*Diagram 7.0*).

5.4 DECKING CARE AND MAINTENANCE

- Inspect a hardwood timber deck at least annually to ensure that it is in good condition.
- Replace or resecure loose or damaged boards and protruding nails or screws.
- To clean the deck, sweep off any loose dirt or garden residue and then clean the deck with a specialised deck cleaning product.
- Once cleaned, lightly sand and reseal the deck with a stain, oil, paint or varnish, depending on aesthetic preference.

After a new timber deck has been built, or an existing deck repaired, it must be thoroughly swept and cleaned to remove metal filings from drilling, nailing or other construction that may cause black spots.

If the deck has turned grey from natural weathering or is discoloured due to metal filings or other construction materials, there are a large range of maintenance and cleaning products on the market which may help bring it back to its natural beauty. Use with care and follow the manufacturer's instructions carefully.

Diagram 6.0

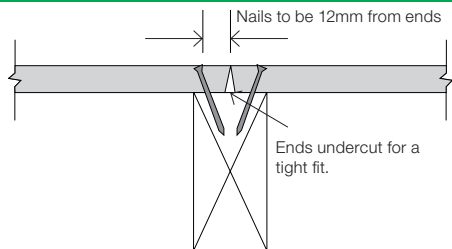

Diagram 7.0

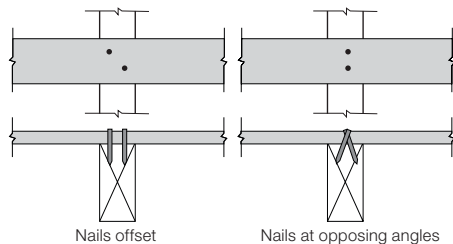
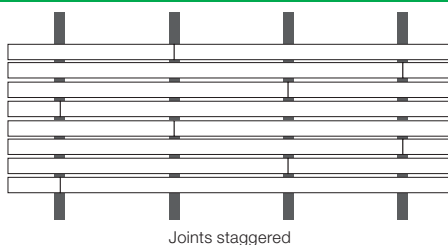

Diagram 5.0



6. Safe work practices

ALL SAFETY STANDARDS SET BY SAFE WORK AUSTRALIA MUST BE FOLLOWED INCLUDING THE FOLLOWING WORK PRACTICES WHEN WORKING WITH TIMBER:

- Work areas must be clean. Sawing, sanding and routing equipment should be fitted with dust extractors. Dust levels should be below standards set by Safe Work Australia for wood dust.
- When machining timber respiratory protection, gloves, clothing, hearing and eye protection should be worn.
- After handling timber, wash skin thoroughly with mild soap and regularly wash clothing.
- Before handling, storing, or using kiln dried timber, it is essential that you read the Boral Timber brochure "What you Should know about Kiln Dried Flooring" Visit www.boral.com.au/timberflooring to download this brochure.
- When using adhesives, coatings and other VOC's ensure that manufacturer's recommendations are followed
- For any treated timber, do not burn offcuts or sawdust. Preservative treated offcuts and sawdust should be disposed of by approved local authority methods.



Responsible
Wood
RW/12-31-38



PEFC™
PEFC/21-31-38

Promoting sustainable forest management

Note: Variations of colour within a timber species are normal, therefore photographs, samples and displays can only be indicative of the colour range of the timber species nominated. Timber is a natural product and commonly reacts to changes in atmospheric and environmental conditions such as humidity and temperature. This is considered normal. It is recommended that species are viewed at a timber showroom before a decision is made on colour.

BCC_16473 4/19

www.boral.com.au/timber

National free call 1800 818 317

©2019 Boral Limited. Boral® and Build something great™ are registered trade marks of Boral Limited or one of its subsidiaries.

