

UF01

Ultraform

Oliveri®

LEFT HAND BOWL SINK

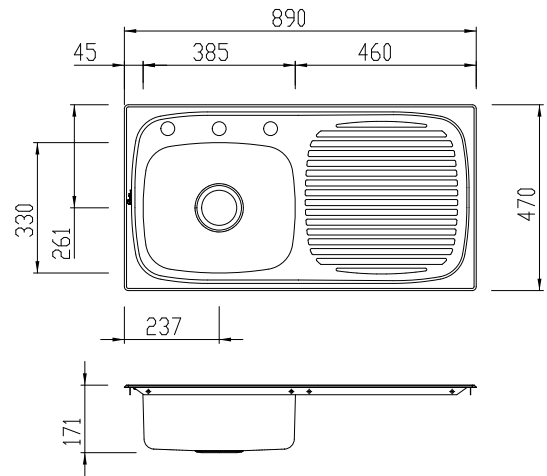

INCLUDED ACCESSORIES

AC14

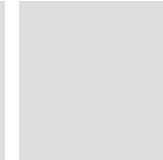
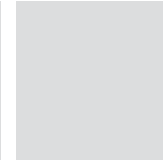
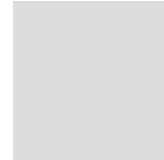
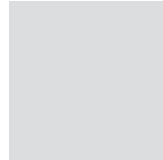
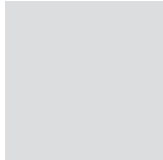

RECOMMENDED TAPWARE

PA113/2



MV617/6



OPTIONAL ACCESSORIES

AC01

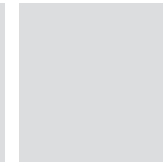
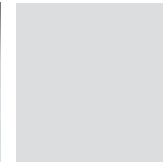
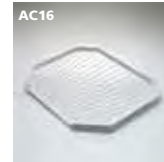

SPECIFICATIONS

Description

Single bowl inset sink with drainer

Sink Size

890W x 470H

Main Bowl

385W x 330H x 155D / 17L

Construction

2 piece, bowls & drainer seam welded

Material

304 grade, 18/10 polished stainless steel (0.8mm thick)

Installation

Inset recommended.

Fixings

Adjustable clips and sealing foam supplied

Cut Out Template

870 x 450 x 15mm radius

Min Cabinet Size

500mm

Tap holes

Available 0 to 3 tap hole (specify when ordering)

Waste fittings

1 x 90mm basket waste included

Overflow

Not available

Carton Size

900 x 480 x 170mm

Weight

4.5kg

Warranty

Lifetime manufacturer's warranty (refer to oliverisinks.com)

For more information call **1300 13 7465** or visit **www.oliverisinks.com**

