

EXAMPLE BED SET-UPS & PACK REQUIREMENTS

**STARTING
PATTERN
DIAGRAM**

1 BOARD
= 150mm high =

2 BOARDS
= 300mm high =

3 BOARDS
= 450mm high =

4 BOARDS
= 600mm high =

5 BOARDS
= 750mm high =

6 BOARDS
= 900mm high =

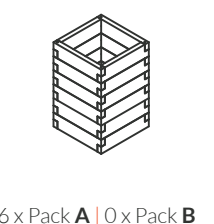
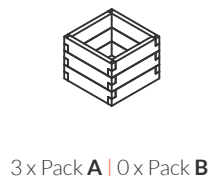
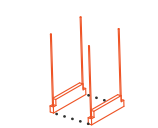
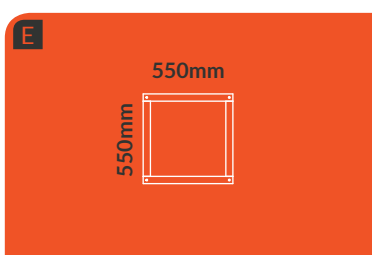
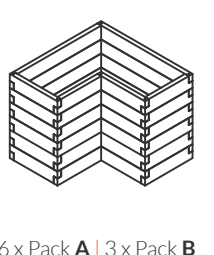
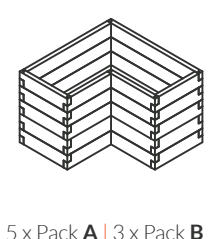
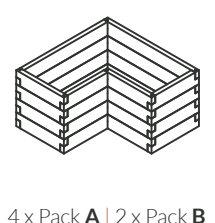
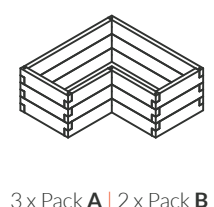
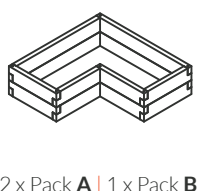
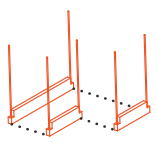
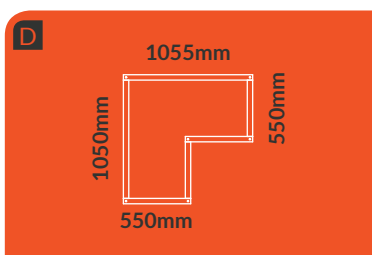
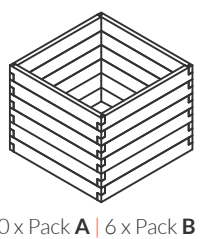
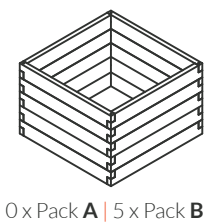
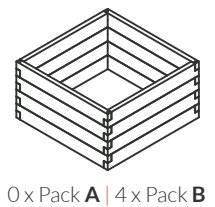
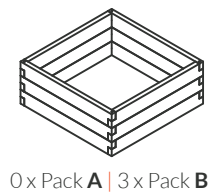
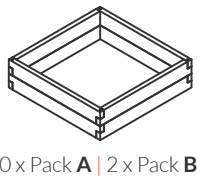
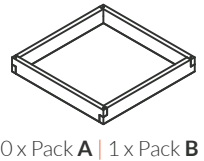
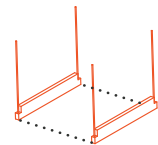
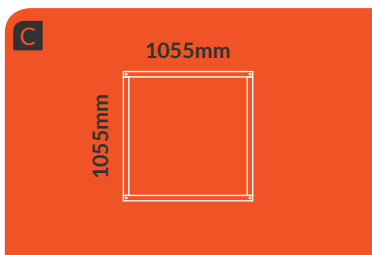
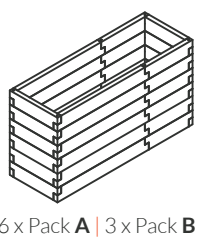
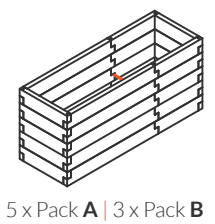
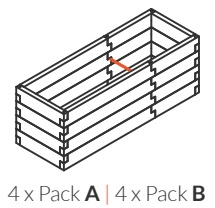
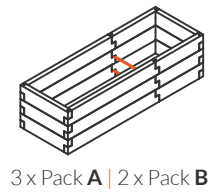
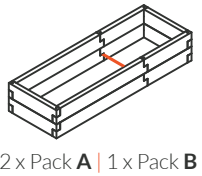
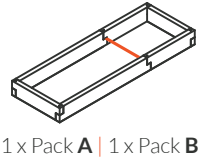
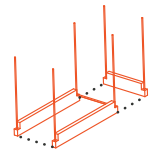
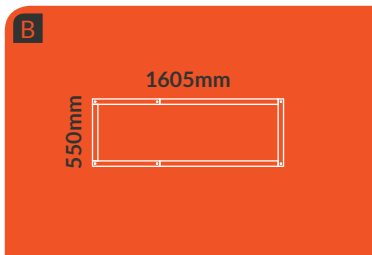
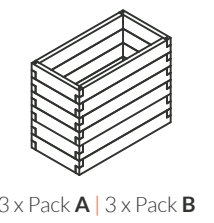
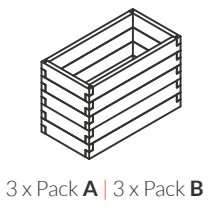
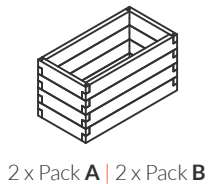
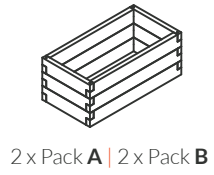
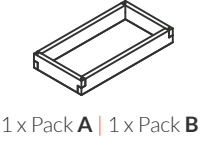
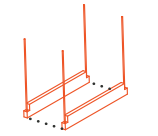
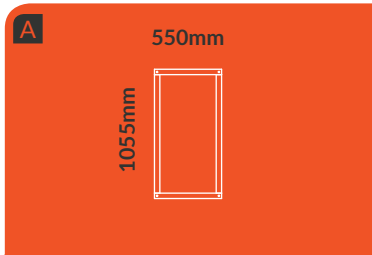

EXAMPLE BED SET-UPS & PACK REQUIREMENTS

**STARTING
PATTERN
DIAGRAM**

1 BOARD
= 150mm high =

2 BOARDS
= 300mm high =

3 BOARDS
= 450mm high =

4 BOARDS
= 600mm high =

5 BOARDS
= 750mm high =

6 BOARDS
= 900mm high =

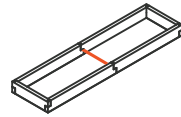
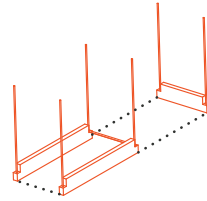
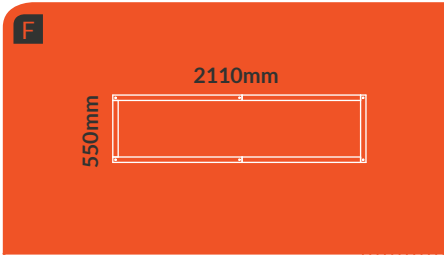

1 x Pack A | 1 x Pack B

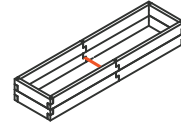

1 x Pack A | 2 x Pack B

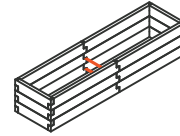

2 x Pack A | 3 x Pack B

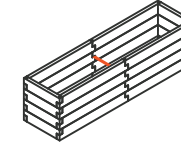

2 x Pack A | 4 x Pack B

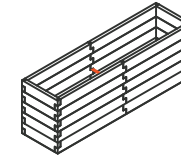

3 x Pack A | 5 x Pack B

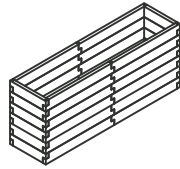

3 x Pack A | 6 x Pack B

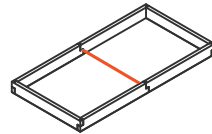
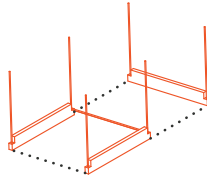
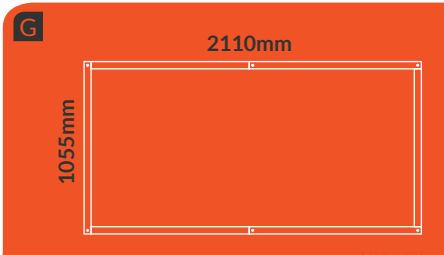

0 x Pack A | 2 x Pack B

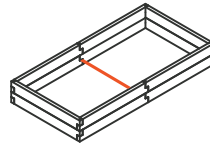

0 x Pack A | 3 x Pack B

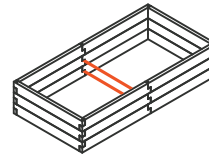

0 x Pack A | 5 x Pack B

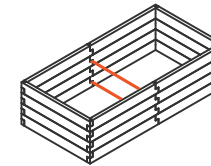

0 x Pack A | 6 x Pack B

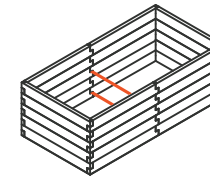

0 x Pack A | 8 x Pack B

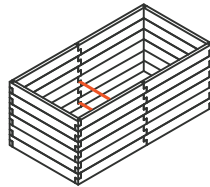

0 x Pack A | 9 x Pack B

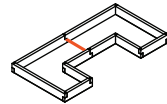
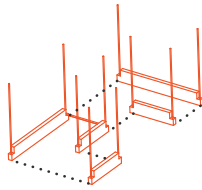
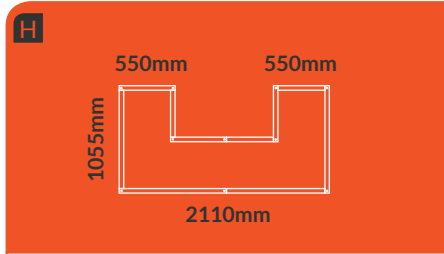

2 x Pack A | 1 x Pack B

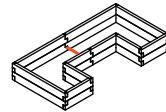

3 x Pack A | 2 x Pack B

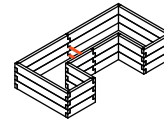

5 x Pack A | 3 x Pack B

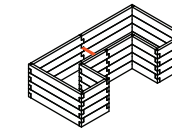

6 x Pack A | 4 x Pack B

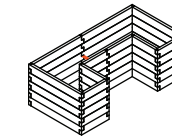

8 x Pack A | 5 x Pack B

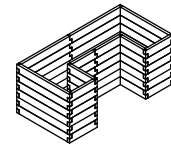

9 x Pack A | 6 x Pack B

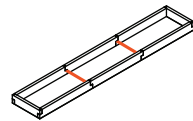
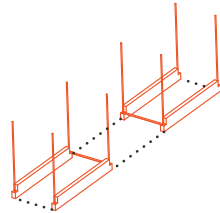
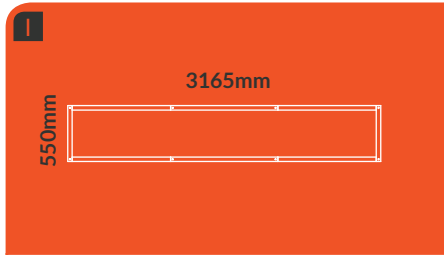

1 x Pack A | 2 x Pack B

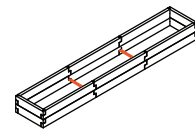

1 x Pack A | 3 x Pack B

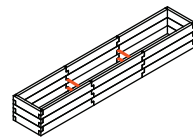

2 x Pack A | 5 x Pack B

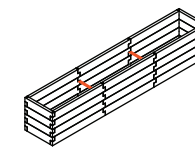

2 x Pack A | 6 x Pack B

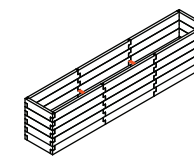

3 x Pack A | 8 x Pack B

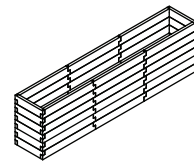

3 x Pack A | 9 x Pack B

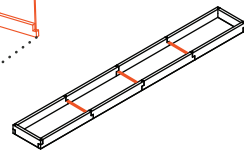
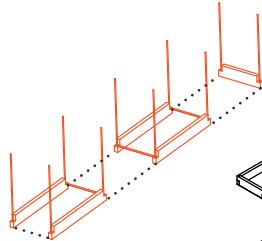
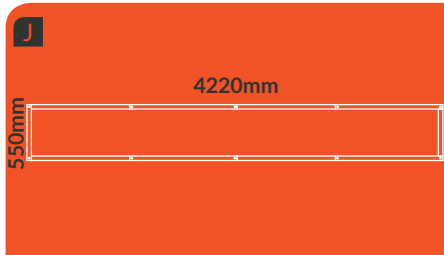

1 x Pack A | 2 x Pack B

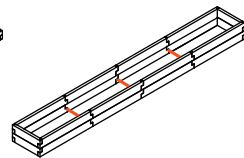

1 x Pack A | 4 x Pack B

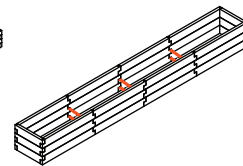

2 x Pack A | 6 x Pack B

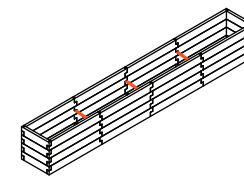

2 x Pack A | 8 x Pack B

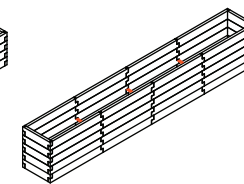

3 x Pack A | 10 x Pack B

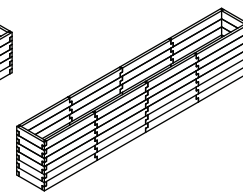

3 x Pack A | 12 x Pack B

EXAMPLE BED SET-UPS & PACK REQUIREMENTS

STARTING
PATTERN
DIAGRAM

1 BOARD
= 150mm high =

2 BOARDS
= 300mm high =

3 BOARDS
= 450mm high =

4 BOARDS
= 600mm high =

5 BOARDS
= 750mm high =

6 BOARDS
= 900mm high =

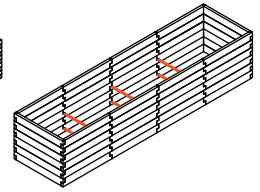
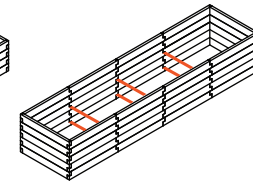
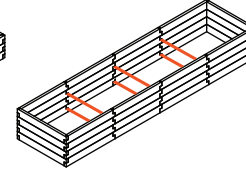
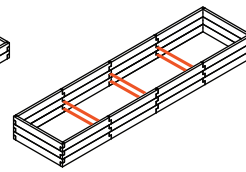
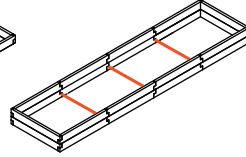
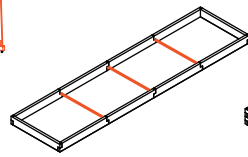
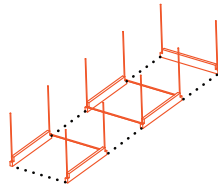
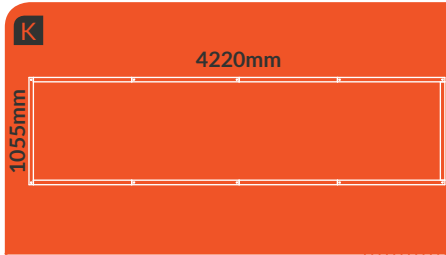

0 x Pack A | 3 x Pack B

0 x Pack A | 5 x Pack B

0 x Pack A | 7 x Pack B

0 x Pack A | 10 x Pack B

0 x Pack A | 13 x Pack B

0 x Pack A | 15 Pack B

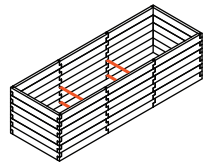
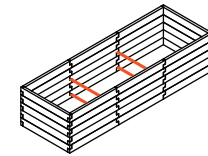
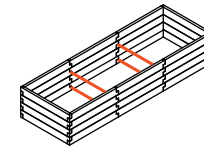
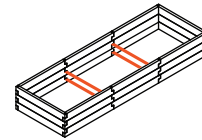
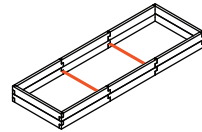
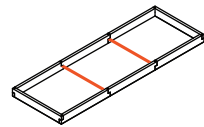
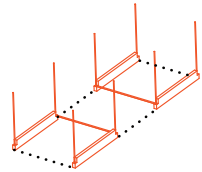
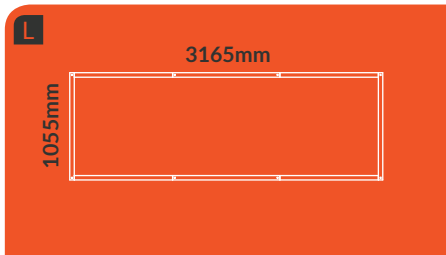

0 x Pack A | 2 x Pack B

0 x Pack A | 4 x Pack B

0 x Pack A | 6 x Pack B

0 x Pack A | 8 x Pack B

0 x Pack A | 10 x Pack B

0 x Pack A | 12 x Pack B

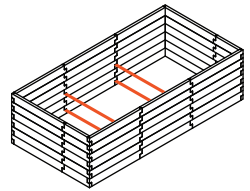
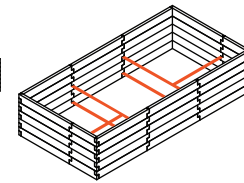
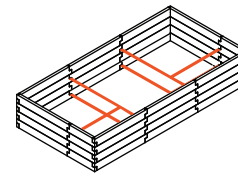
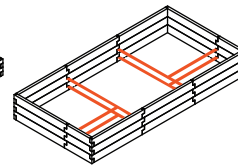
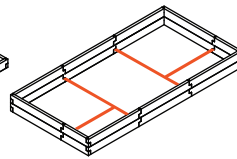
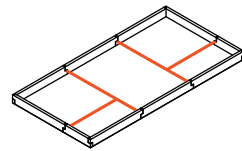
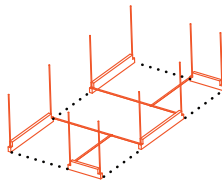
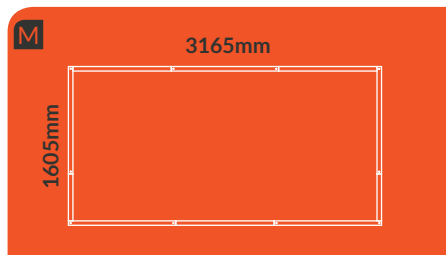

1 x Pack A | 2 x Pack B

1 x Pack A | 4 x Pack B

2 x Pack A | 6 x Pack B

2 x Pack A | 8 x Pack B

3 x Pack A | 10 x Pack B

3 x Pack A | 12 x Pack B

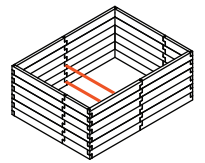
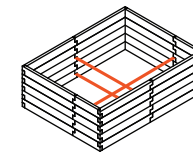
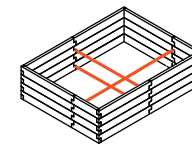
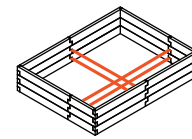
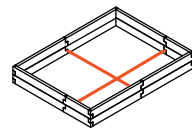
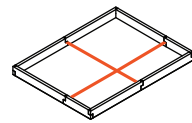
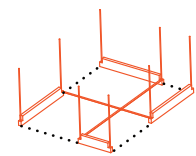
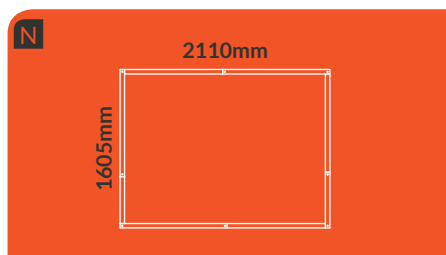

1 x Pack A | 2 x Pack B

1 x Pack A | 3 x Pack B

2 x Pack A | 5 x Pack B

2 x Pack A | 6 x Pack B

3 x Pack A | 8 x Pack B

3 x Pack A | 9 x Pack B

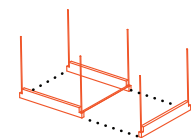
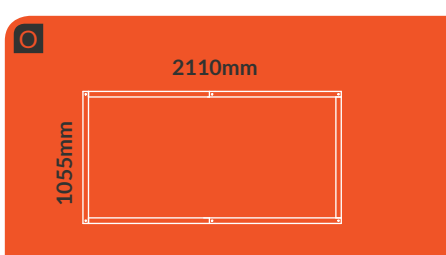

—

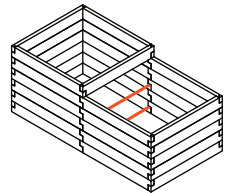
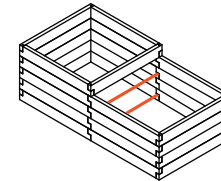
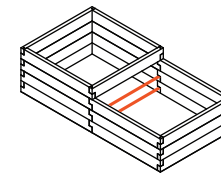
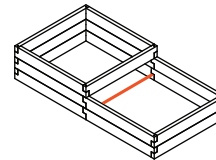
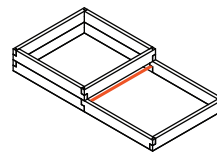

0 x Pack A | 3 x Pack B

0 x Pack A | 5 x Pack B

0 x Pack A | 6 x Pack B

0 x Pack A | 7 x Pack B

0 x Pack A | 9 x Pack B

EXAMPLE BED SET-UPS & PACK REQUIREMENTS

STARTING
PATTERN
DIAGRAM

1 BOARD
= 150mm high =

2 BOARDS
= 300mm high =

3 BOARDS
= 450mm high =

4 BOARDS
= 600mm high =

5 BOARDS
= 750mm high =

6 BOARDS
= 900mm high =

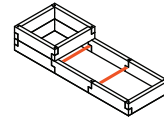
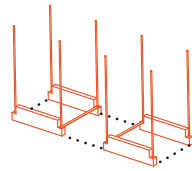
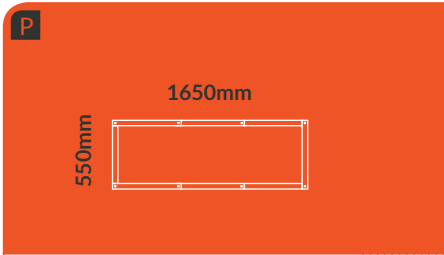

3 x Pack **A** | 0 x Pack **B**

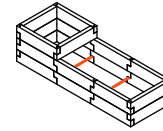

5 x Pack **A** | 0 x Pack **B**

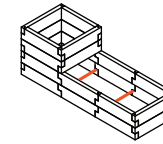

6 x Pack **A** | 0 x Pack **B**

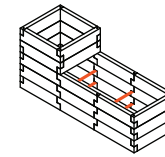

8 x Pack **A** | 0 x Pack **B**

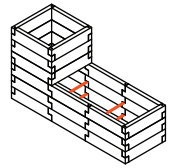

9 x Pack **A** | 0 x Pack **B**

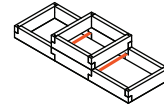
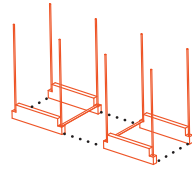
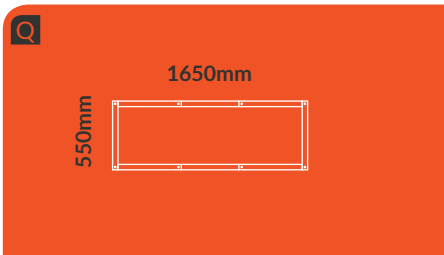

3 x Pack **A** | 0 x Pack **B**

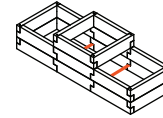

5 x Pack **A** | 0 x Pack **B**

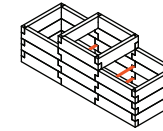

7 x Pack **A** | 0 x Pack **B**

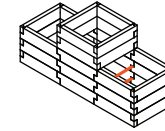

8 x Pack **A** | 0 x Pack **B**

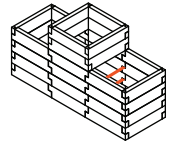

10 x Pack **A** | 0 x Pack **B**

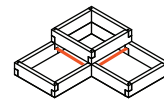
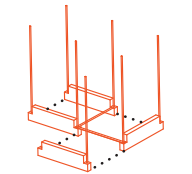
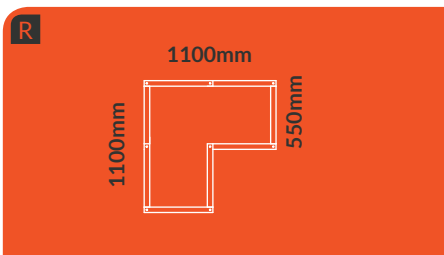

3 x Pack **A** | 0 x Pack **B**

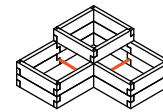

5 x Pack **A** | 0 x Pack **B**

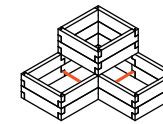

6 x Pack **A** | 0 x Pack **B**

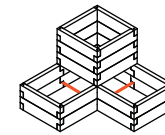

6 x Pack **A** | 0 x Pack **B**

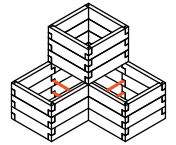

8 x Pack **A** | 0 x Pack **B**

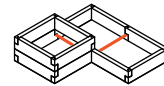
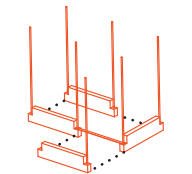
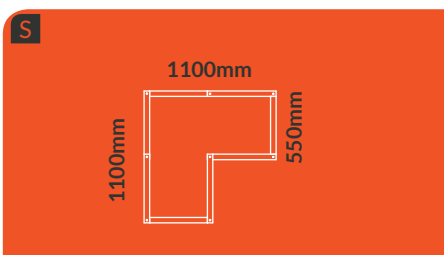

3 x Pack **A** | 0 x Pack **B**

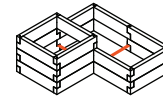

5 x Pack **A** | 0 x Pack **B**

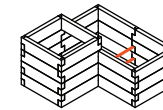

7 x Pack **A** | 0 x Pack **B**

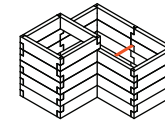

9 x Pack **A** | 0 x Pack **B**

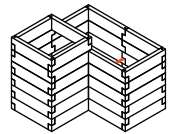

11 x Pack **A** | 0 x Pack **B**

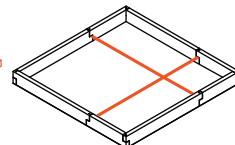
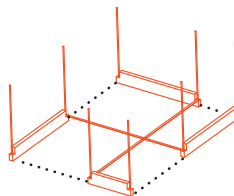
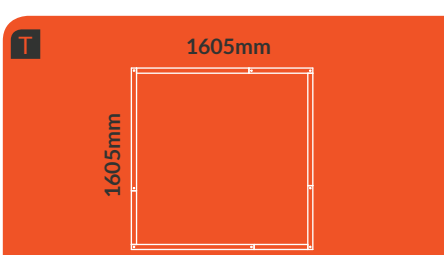

1 x Pack **A** | 1 x Pack **B**

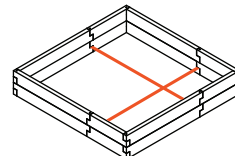

2 x Pack **A** | 2 x Pack **B**

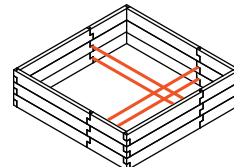

3 x Pack **A** | 3 x Pack **B**

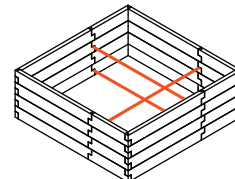

4 x Pack **A** | 4 x Pack **B**

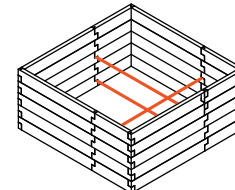

5 x Pack **A** | 5 x Pack **B**

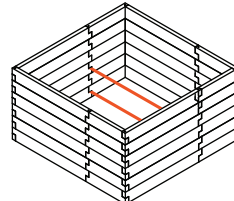

6 x Pack **A** | 6 x Pack **B**

EXAMPLE BED SET-UPS & PACK REQUIREMENTS

**STARTING
PATTERN
DIAGRAM**

1 BOARD

= 150mm high =

2 BOARDS

= 300mm high =

3 BOARDS

= 450mm high =

4 BOARDS

= 600mm high =

5 BOARDS

= 750mm high =

6 BOARDS

= 900mm high =

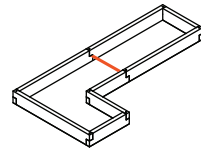
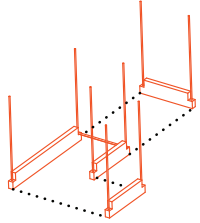
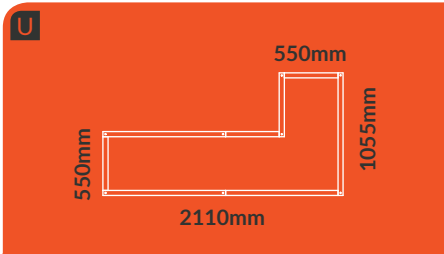

1 x Pack **A** | 1 x Pack **B**

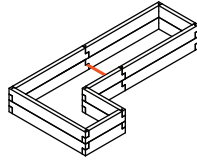

2 x Pack **A** | 2 x Pack **B**

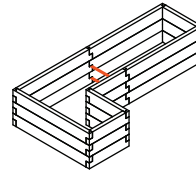

3 x Pack **A** | 3 x Pack **B**

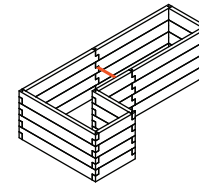

4 x Pack **A** | 4 x Pack **B**

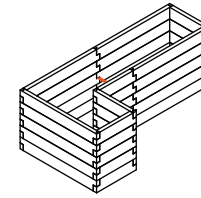

5 x Pack **A** | 5 x Pack **B**

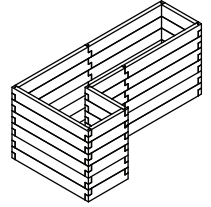

6 x Pack **A** | 6 x Pack **B**

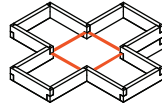
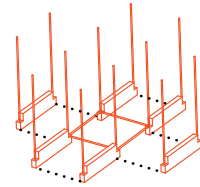
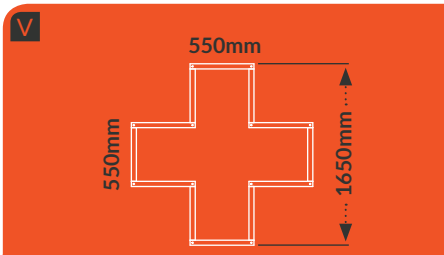

3 x Pack **A** | 0 x Pack **B**

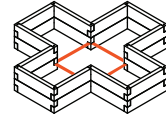

6 x Pack **A** | 0 x Pack **B**

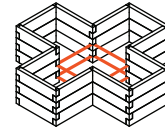

9 x Pack **A** | 0 x Pack **B**

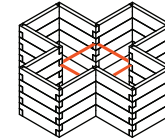

12 x Pack **A** | 0 x Pack **B**

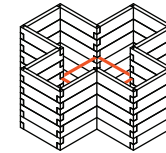

15 x Pack **A** | 0 x Pack **B**

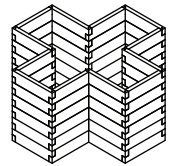

18 x Pack **A** | 0 x Pack **B**

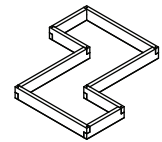
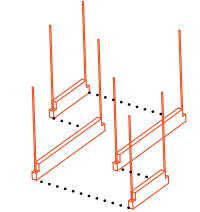
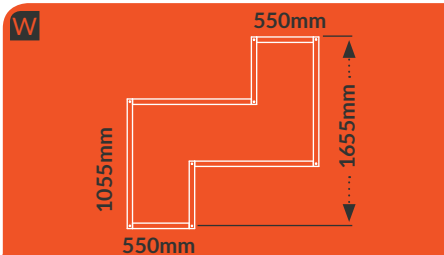

1 x Pack **A** | x Pack **B**

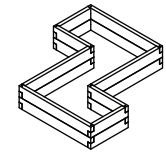

2 x Pack **A** | 2 x Pack **B**

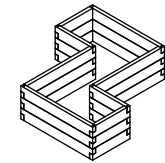

3 x Pack **A** | 3 x Pack **B**

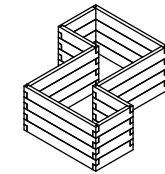

4 x Pack **A** | 4 x Pack **B**

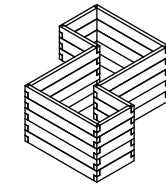

5 x Pack **A** | 5 x Pack **B**

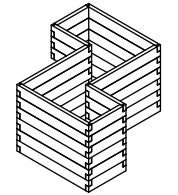

6 x Pack **A** | 6 x Pack **B**

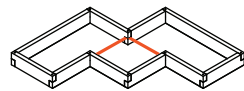
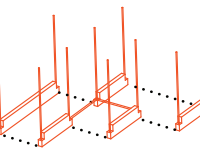

2 x Pack **A** | 1 x Pack **B**

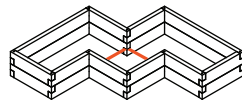

4 x Pack **A** | 1 x Pack **B**

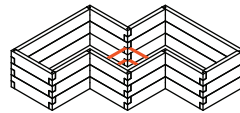

6 x Pack **A** | 2 x Pack **B**

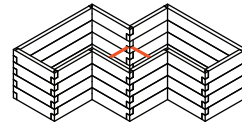

8 x Pack **A** | 2 x Pack **B**

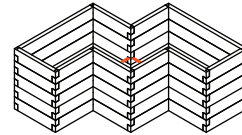

10 x Pack **A** | 3 x Pack **B**

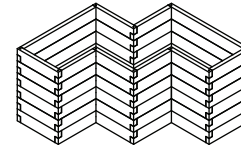

12 x Pack **A** | 3 x Pack **B**

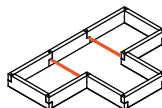
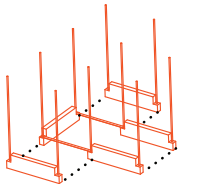
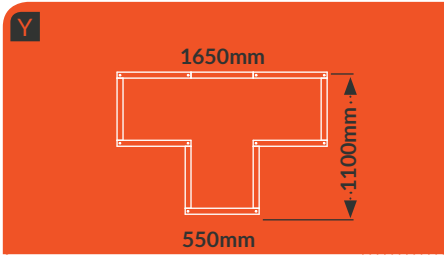

3 x Pack **A** | 0 x Pack **B**

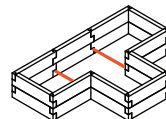

5 x Pack **A** | 0 x Pack **B**

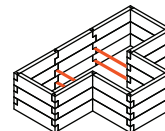

8 x Pack **A** | 0 x Pack **B**

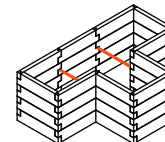

10 x Pack **A** | 0 x Pack **B**

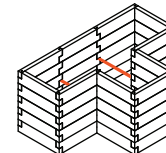

13 x Pack **A** | 0 x Pack **B**

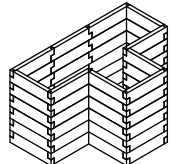

15 x Pack **A** | 0 x Pack **B**

EXAMPLE BED & BENCH SEAT SET-UPS & PACK REQUIREMENTS

STARTING
PATTERN
DIAGRAM

STARTING
PATTERN
DIAGRAM

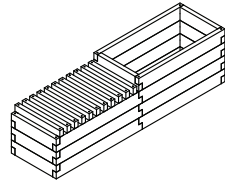
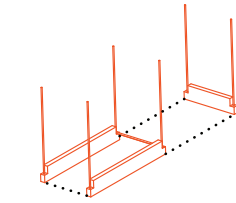
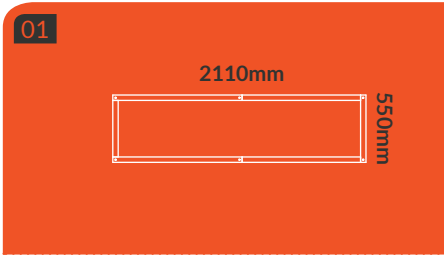

5 x Pack A | 4 x Pack B

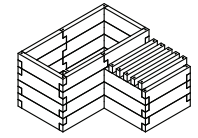
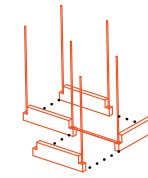
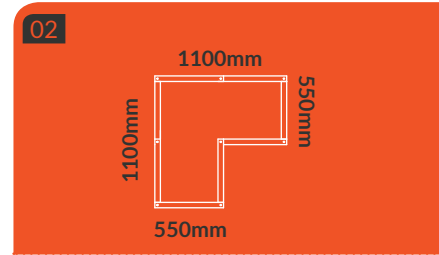

9 x Pack A | 0 x Pack B

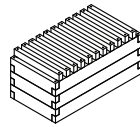
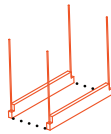
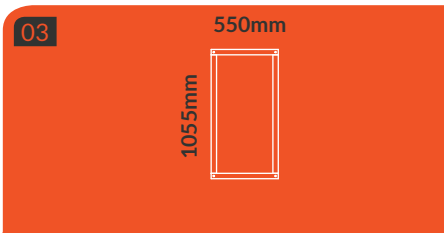

4 x Pack A | 2 x Pack B

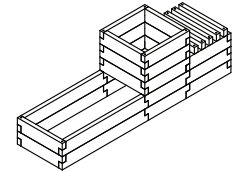
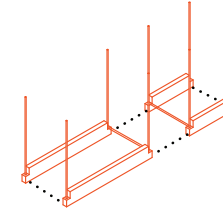
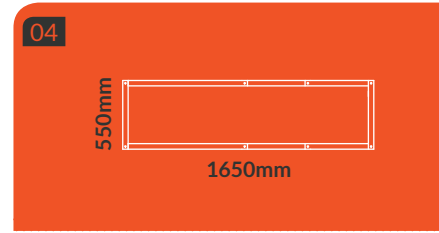

8 x Pack A | 1 x Pack B

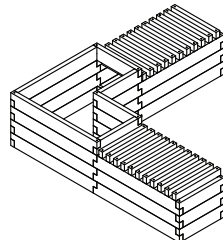
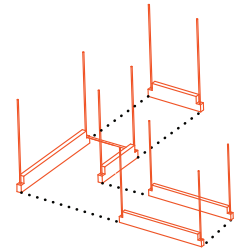
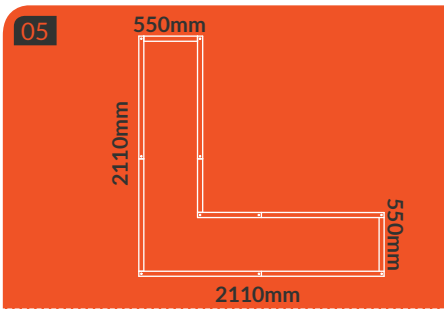

9 x Pack A | 5 x Pack B

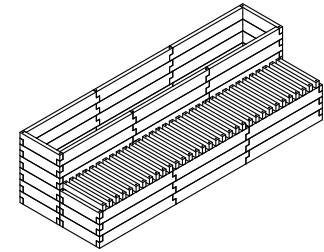
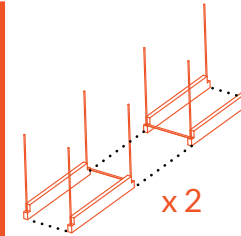
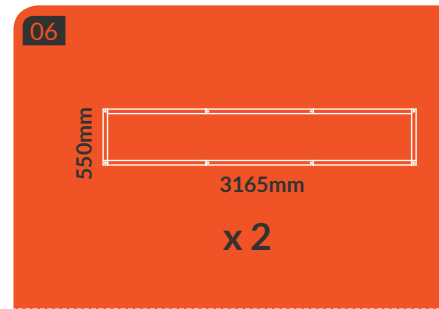

13 x Pack A | 14 x Pack B

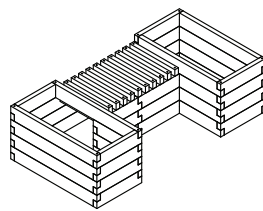
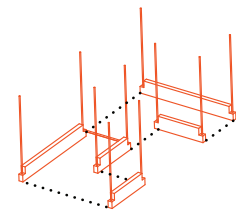
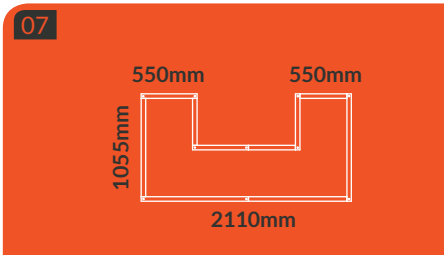

8 x Pack A | 4 x Pack B

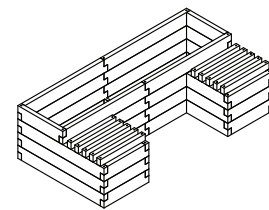

8 x Pack A | 4 x Pack B

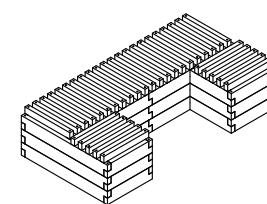

13 x Pack A | 3 x Pack B

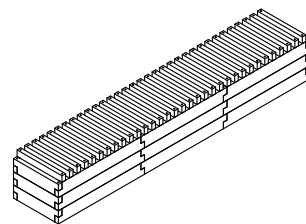
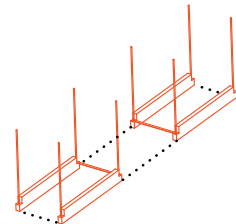
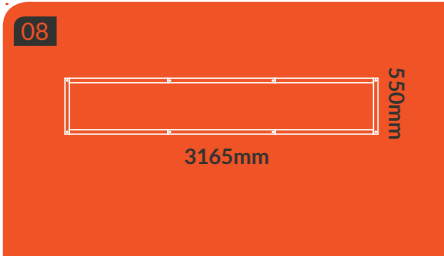

10 x Pack A | 5 x Pack B

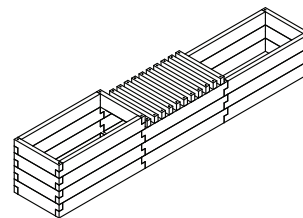

5 x Pack A | 5 x Pack B

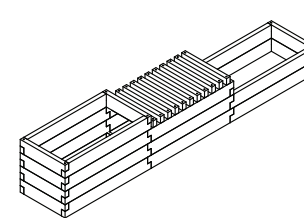

5 x Pack A | 5 x Pack B

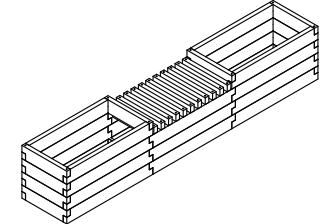

5 x Pack A | 6 x Pack B