

A young man with short brown hair and a friendly smile is wearing a blue long-sleeved work shirt. He is sitting at a desk in what appears to be a workshop or office, with various plumbing parts and blueprints visible. He is holding a yellow pencil in his right hand. The background is slightly blurred, showing some green equipment.

The Abey Plumber's Guide

Aussie Made for Aussie Trades



abeytrade.com.au

In the beginning there was Man...

Then the Wife arrived and wanted a new place to live, complete with all the mod-cons including an ensuite, a powder room, toilet, bathroom with hot and cold running water, shower and spa, a kitchen with a plumbed-in water filter, dishwasher, triple bowl sink and mixer tap, laundry with water saver washer, outside hot and cold tap to wash the dog, a swimming pool for when the kids arrive with an outdoor shower and some rainwater tanks and grey water recycling system and a reticulation watering system for the manicured gardens with a small water feature...

A close-up photograph of a plumber wearing a yellow hard hat and safety glasses. He is focused on his work, holding a large white pipe with both hands. A metal tool is visible, positioned to cut or adjust the pipe. The background is dark, making the worker and the pipe stand out.

Then came the Plumber



abeytrade.com.au

Introduction

This Plumbing Guide has been developed to assist plumbers in selecting and using a range of Abey plumbing products. Abey is a wholly Australian owned 3rd generation family company. All Abey plumbing products are proudly Australian made to conform to Australian and New Zealand Building Standards and conditions. Other products in the Abey range have been sourced and selected from all over the world as being “best of breed”, providing plumbers the best world-class solutions that help save time, money or space. Abey have been assisting plumbers for over 50 years by developing and manufacturing innovative and unique plumbing products, which is why Abey are ‘The Tradesman’s Choice’.



abeytrade.com.au



Contents

| | |
|---|--------------|
| Introduction | 4 |
| The Fight Against Corrosion – Plumbing Tips | 6 |
| Interchangeable Bolted Clips | 8-13 |
| – Bolted Clip Heads | |
| – Brackets, Shanks & Extensions | |
| – Adjustable Stand Off Brackets | |
| – Welded Nuts & All Thread Brackets | |
| Spacing of Brackets & Clips – Handy Info | 9 |
| The Fastest Clipping System in the World | 14-19 |
| – Speed Clips | |
| – Speed Clip Brackets | |
| Industrial Bolted Clips | 20-29 |
| – Stand Off Clips | |
| – Stand Off Brackets | |
| – Nut Clips | |
| – Hanging Clips | |
| – All Thread Clips | |
| – Pear Clips | |
| Standard Pipe Clipping | 30-33 |
| – Saddle Clips | |
| Abey Fantastic Plastic Products | 34-45 |
| – Air Admittance Valves (Ventapipe) | |
| – All-in-one Traps | |
| – Bottle Traps & Compression Valves | |
| – WC Connectors | |
| – Macvalve Self-Closing Waste Valve | |
| – Flexible Waste Connectors | |
| – Accessories | |
| – Trapped Gullies | |
| General Plumbing | 46-47 |
| – Stainless Steel Cover Plates | |
| Roofing | 48-59 |
| – Downpipe Pops & Clips | |
| – Crimp Bends, China Hat Cowl & Rainheads | |
| – Type "B" Gas Vent | |
| – Direct Vent Pro | |
| – General Gas Flueing Products | |
| – Rangehood Flueing Kits & Flueing Products | |

The Fight Against Corrosion

The scourge of the plumbing industry has to be the effects that corrosion has on plumbing products and materials. Pipe clips are prone to corrosion and unless correctly engineered and coated can break down and become a problem, especially in highly corrosive environment such as close to the sea. Welding is old and outdated technology. The weakest link can always be found in the weld. When it comes to clipping products, welding undermines the strength of the steel and is prone to corrosion. Abey's continual improvement program is developing products that fight the rust.



Abey understand this problem and are leading the way by phasing out welded products for good by developing and re-engineering their products.



Abey products are correctly coated and accurately machine pressed, offering consistent quality, superior strength and are less prone to corrosion. And importantly, they are a superior locally made products that cost around the same as inferior, cheap welded imports.

Fighting Corrosion



Welded Nut Clip – Welding undermines the strength of the steel and is prone to corrosion.



Machine Pressed – Machine pressed clipping products provide a greater strength than welding and are less prone to corrosion.



Materials and coatings on most imported clips are often dubious and may not conform to AS/NZ building standards.



Manufactured and supported locally, Abey products conform to AS/NZ building codes.



When your cheap Chinese clip breaks down, who do you complain to? Abey provides full nation wide support.



Hi tensile zinc coated nuts and bolts are often included. Quality of materials and coatings guaranteed.

INTERCHANGEABLE BOLTED CLIPS

The leaders in innovation, Abey understand the plumbing industry and the needs of tradesmen. Over the years they have continuously developed products designed to be simple to use, highly effective and totally reliable. Abey Australia, a leading manufacturer of plumbing products for over 60 years has introduced a number of innovations for plumbers over the years to simplify their work. Given the importance of time in the building and plumbing industry, contractors and tradies are constantly looking for better ways of doing even the simplest of jobs faster, efficiently and cost-effectively. Abey's first interchangeable bolted clipping system revolutionised the plumbing industry, and became the industry standard for over 30 years.

Abey's 'interchangeable' bolted clipping system has been engineered to the most stringent specifications and manufactured to suit all pipe sizes for domestic installations. Manufactured in Australia from G2-Z275 galvanised steel and further powder coated to colour match Copper, BSP, HDPE and DWV pipes as well as extra corrosion resistant stainless steel.



Watch our instructional video at abeytrade.com.au

- The system provides a more streamlined and superior aesthetic finish
- Engineered to meet Australian and New Zealand building Codes
- Unique engineering feature creates a system of interchangeable Clips, Shanks and Brackets to minimise stock

All Clip Heads engineered to meet exact specifications to allow for expansion and contraction. Notice the elongated recess and square hole. They are designed to ensure perfect alignment and eliminate movement.



Spacing of Brackets & Clips

The following spacing limitations for horizontal and vertical piping are derived from AS 3500. It is to be noted that with fire sprinkler installations an additional bracket is required to support a sprinkler branch within 300mm of the sprinkler.

Sprinkler piping shall be supported from structural members and clips designed to withstand the anticipated stresses and loads. Piping shall be secured to restrict movement during its normal life and upon sprinkler operation.

| SPACING OF BRACKETS AND CLIPS | | | | |
|--------------------------------|--|---------------------------|--|----------|
| Nominal Copper/Steel Pipe Size | Maximum Spacing Of Brackets & Clips (Metres) | Nominal Plastic Pipe Size | Maximum Spacing Of Brackets & Clips (Metres) | |
| | | | Horizontal | Vertical |
| DN20 | 1.5 | DN20 | .70 | 1.40 |
| DN25 | 2.0 | DN25 | .75 | 1.50 |
| DN32 | 2.5 | DN32 | .85 | 1.70 |
| DN40 | 2.5 | DN40 | .90 | 1.80 |
| DN50 | 3.0 | DN50 | 1.05 | 2.10 |
| DN65 | 3.0 | DN65 | 1.20 | 2.40 |
| DN80 | 4.0 | DN80 | 1.30 | 2.60 |
| DN90 | 4.0 | DN90 | 1.40 | 2.80 |
| DN100 | 4.0 | DN100 | 1.50 | 3.00 |
| DN125 | 4.0 | DN125 | 1.70 | 3.40 |
| DN150 | 4.0 | DN150 | 2.00 | 4.00 |









DISCLAIMER: The information in this publication has been assembled for guidance only. Care has been taken to ensure accuracy, but no liability can be accepted for any consequence which may arise as a result of its application. It may not be reproduced in whole or in part without the written consent of Abey Australia Pty Ltd.

INTERCHANGEABLE BOLTED CLIPS BOLTED CLIP HEADS

| PRODUCT DESCRIPTION | | CODE |
|---|--|-------|
| PVC PIPE BOLTED CLIP HEADS – GALVANISED & POWDERCOATED WHITE Also Stainless Steel | DN40 1½" (20 per box) | 0001 |
| | DN50 2" (20 per box) | 0002 |
| | DN50 2" (20 per box) Stainless Steel | 0002S |
| | DN65 2½" (20 per box) | 0003 |
| | DN80 3" (20 per box) | 0004 |
| | DN90 3½" (20 per box) | 0049 |
| | DN80 3" (20 per box) Stainless Steel | 0010S |
| | DN100 4" (20 per box) | 0005 |
| | DN100 4" (20 per box) Stainless Steel | 0005S |
| | DN150 6" (20 per box) | 0006 |
| PVC EXPANSION BOLTED CLIP HEADS – GALVANISED & POWDERCOATED GREY | DN40 1½" (20 per box) | 0007 |
| | DN50 2" (20 per box) | 0008 |
| | DN65 2½" (20 per box) | 0009 |
| | DN80 3" (20 per box) | 0010 |
| | DN100 4" (20 per box) | 0011 |
| COPPER BOLTED CLIP HEADS – GALVANISED & POWDERCOATED COPPER Copper Pipe Bolted Clips | DN15 ½" (20 per box) | 0026 |
| | DN20 ¾" (20 per box) | 0027 |
| | DN25 1" (20 per box) | 0028 |
| | DN32 1¼" (20 per box) | 0029 |
| | DN40 1½" (20 per box) | 0030 |
| | DN50 2" (20 per box) | 0031 |
| | DN65 2½" (20 per box) | 0032 |
| | DN80 3" (20 per box) | 0033 |
| DN100 4" (20 per box) | 0034 | |
| PRESSURE PIPE CLIP HEADS – POWDERCOATED WHITE Pressure Pipe Bolted Clips | DN15 ½" (20 per box) | 0040 |
| | DN20 ¾" (20 per box) | 0041 |
| | DN25 1" (20 per box) | 0042 |
| | DN32 1¼" (20 per box) | 0043 |
| | DN40 1½" (20 per box) | 0044 |
| | DN50 2" (20 per box) | 0045 |
| | DN65 2½" (20 per box) | 0046 |
| | DN80 3" (20 per box) | 0047 |
| BOLTED CLIP HEADS HDPE PIPE OD – GALVANISED & POWDERCOATED BLACK HDPE Pipe Bolted Clips | 50mm (20 per box) | 0161 |
| | 56mm (20 per box) | 0162 |
| | 63mm (20 per box) | 0163 |
| | 75mm (20 per box) | 0164 |
| | 90mm (20 per box) | 0165 |
| | 110mm (20 per box) | 0166 |



INTERCHANGEABLE BOLTED CLIPS BRACKETS, SHANKS & EXTENSIONS

| PRODUCT DESCRIPTION | | CODE |
|---|---|-------|
| BRACKETS, SHANKS & EXTENSIONS – GALVANISED Bolted Clip Shanks | 150mm (25 per box) | 0051 |
| | 300mm (25 per box) | 0053 |
| | 450mm (10 per bag) | 0054 |
| | 600mm (10 per bag) | 0055 |
| |  | |
| Extension Arms | 300mm (50 per box) | 0058 |
| |  | |
| Light Hanging Brackets | 300mm (50 per box) | 0059 |
| | 600mm (10 per bag) | 0082 |
|  | | |
| Welded Nuts | 10mm (50 per box) | 0063 |
| |  | |
| V Legs | (20 pair) | 0066 |
| |  | |
| Nuts and Bolts SHK | 7 x 25mm (100 per bag) | 0068 |
| |  | |
| Stand Off Brackets | Galvanised (50 per box) | 0060 |
| | Powder Coated (50 per box) | 0078 |
| | Stainless Steel (20 per box) | 0060S |
| Adjustable Stand Off Brackets | Galvanised (25 per box) | 0080 |
| | Powder Coated (25 per box) | 0079 |
| | Stainless Steel (20 per box) | 0080S |
|  | | |
| All Thread Brackets | includes 2 x 10mm Nuts (50 per box) | 0061M |
| | 10mm with Welded Nut (50 per box) | 5061 |
|  | | |

INTERCHANGEABLE BOLTED CLIPS ADJUSTABLE STAND OFF BRACKETS

Abey's Adjustable Stand Off Bracket is a very versatile tool that should be part of every plumber's kit. It comes in 2 parts, and with a pair of pliers can easily be snapped off to any required length from 30-60mm. Then fit them off as you would a normal Stand Off Bracket. They can be used in uneven wall situations to provide a straight fitting point. They can also be used in underfloor situations to fit off pipes. Simply snap off to create the proper fall allowance. Available in Powder Coated – White, Galvanised and Stainless Steel.

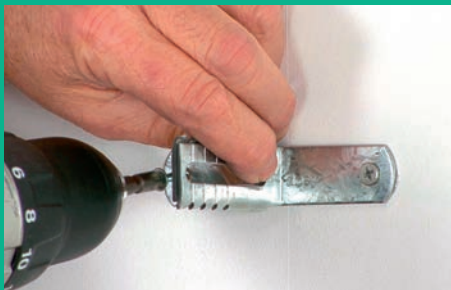
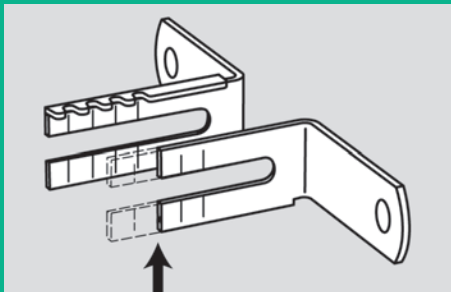

Abey's Adjustable Stand Off Bracket comes in two pieces. Simply measure the distance for the pipe to stand off the wall, and snap bracket to appropriate size. See instructional web video – www.abeytrade.com.au

ABEY'S WELDED NUTS AND ALL THREAD BRACKETS

Abey's welded nut and all thread brackets are designed for use with the Abey bolted clipping system for pipe work from 13mm to 150mm. Strength tested to 1500kg's.



INSTALLATION INSTRUCTIONS FOR WELDED NUT BRACKET

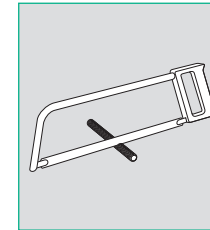

Cut All Thread rod to required length.

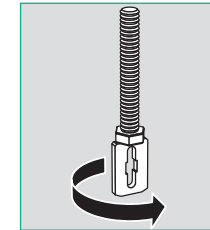

Screw Abey's Welded Nut onto end of All Thread rod.

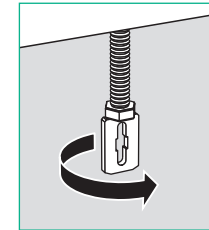

Screw thread assembly into anchorage point and tighten with spanner.

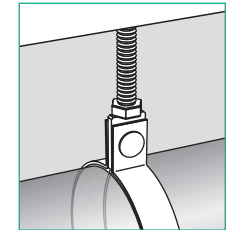

Connect clip and pipe to assembly.

INSTALLATION INSTRUCTIONS FOR ALL THREAD BRACKET

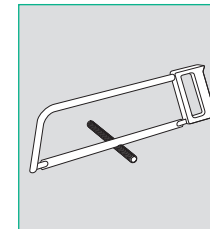

Cut All Thread rod to required length.

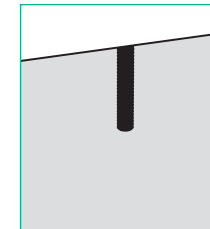

Screw Abey's All Thread Bracket onto end of All Thread rod.

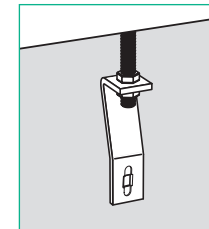

Fit All Thread Bracket to threaded rod with nuts provided.

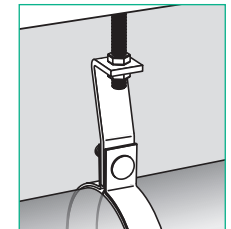

Fit bolted clip and pipe as required and adjust to pipe fall.







THE FASTEST CLIPPING SYSTEM IN THE WORLD SPEED CLIPS

Hanging pipes can often prove to be an awkward if not dangerous task, especially when trying to fit and hold heavy pipe work while fiddling about with nuts and bolts. Abey have eliminated the need for using nuts and bolts to fasten clips to brackets with their innovative new Speed Clip System. This totally integrated system has been designed and engineered to the most stringent specifications and manufactured to suit commonly used copper, PVC and expansion pipes. The clips and brackets are fully interchangeable and have been designed for use in most common plumbing applications. See instructional web video – www.abeytrade.com.au

- ✓ Faster installation
- ✓ Speediest click & go system ever
- ✓ Australian designed and made
- ✓ Fully integrated system
- ✓ Quality that's built to last
- ✓ Superior to cheap imports



THE FASTEST CLIPPING SYSTEM IN THE WORLD
FULLY INTERCHANGEABLE SPEED CLIPS

| |  |  |  |
|---|---|---|---|
| | Copper Pipe Clips 12-100mm | PVC Pipe Clips 40-150mm | Expansion Pipe Clips 65-100mm |
| HANGING BRACKETS 300MM & 600MM  | ✓ | ✓ | ✓ |
| ALL THREAD BRACKET  | ✓ | ✓ | ✓ |
| ALL THREAD PRESSED NUT BRACKET  | ✓ | ✓ | ✓ |
| STAND OFF BRACKET  | ✓ | ✓ | ✓ |
| ADJUSTABLE STAND OFF BRACKET  | ✓ | ✓ | ✓ |

THE FASTEST CLIPPING SYSTEM IN THE WORLD
SPEED CLIP INSTALLATION

HANGING BRACKET

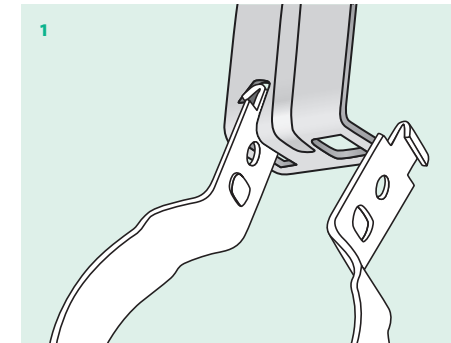

Step 1 – Engage clip to bracket through keyhole slot.

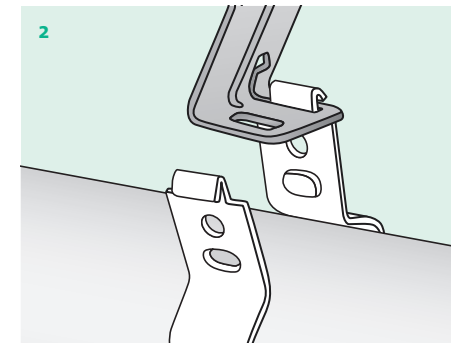

Step 2 – Install pipe as required. Pipes can be pre-hung.

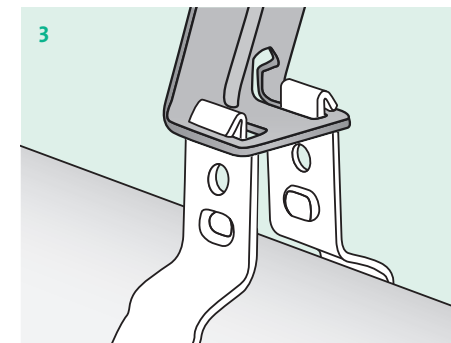

Step 3 – Simply lock clip to bracket.

STAND OFF BRACKET

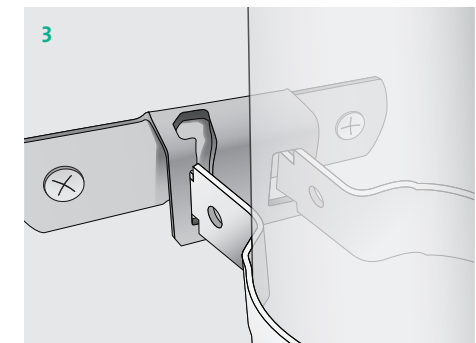
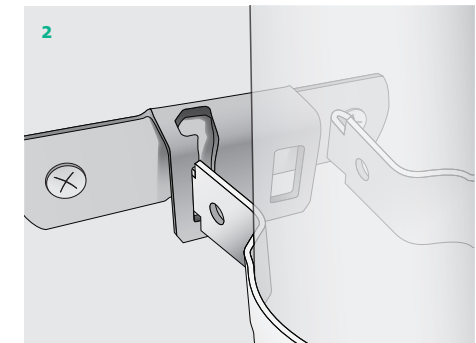
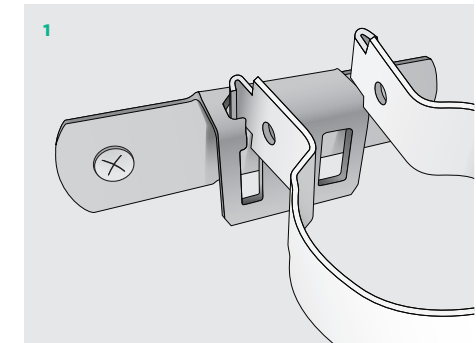

THE FASTEST CLIPPING SYSTEM IN THE WORLD SPEED CLIPS

| PRODUCT DESCRIPTION | | CODE |
|---|--------------------------------|------|
| SPEED CLIPS FOR PVC PIPE Galvanised/powder coated | 40mm (20 per box) | 7001 |
| | 50mm (20 per box) | 7002 |
| | 65mm (20 per box) | 7003 |
| | 75mm (20 per box) | 7004 |
| | 90mm (stormwater) (20 per box) | 7049 |
| | 100mm (20 per box) | 7005 |
| | 150mm (20 per box) | 7006 |
| SPEED CLIPS EXPANSION PIPE Galvanised/powder coated | 65mm (20 per box) | 7009 |
| | 80mm (20 per box) | 7010 |
| | 100mm (20 per box) | 7011 |
| SPEED CLIPS FOR COPPER PIPE Galvanised /powder coated | 12mm (20 per box) | 7026 |
| | 18mm (20 per box) | 7027 |
| | 25mm (20 per box) | 7028 |
| | 32mm (20 per box) | 7029 |
| | 37mm (20 per box) | 7030 |
| | 50mm (20 per box) | 7031 |
| | 65mm (20 per box) | 7032 |
| | 75mm (20 per box) | 7033 |
| | 100mm (20 per box) | 7034 |



THE FASTEST CLIPPING SYSTEM IN THE WORLD SPEED CLIP BRACKETS

| PRODUCT DESCRIPTION | | CODE |
|----------------------------------|---|------|
| SPEED HANGING BRACKETS | Galvanised 300mm (50 per box) | 7059 |
| | Galvanised 600mm (10 per pack) | 7064 |
| SPEED STAND OFF BRACKETS | Galvanised (50 per box) | 7060 |
| | Galvanised (25 per box) | 7080 |
| SPEED ALL THREAD BRACKETS | Galvanised (50 per box) includes 2 nuts | 7061 |
| | Galvanised (50 per box) | 7062 |



INDUSTRIAL BOLTED CLIPS

Abey provide national distribution and support for all their products. So when help or advice is required, Abey are always on hand and stand behind their products. For more information about Abey's Industrial Clipping range, see instructional web video – www.abeytrade.com.au



INDUSTRIAL STAND OFF CLIPS

Abey Industrial Stand Off Clips for PVC pipe, are a 2 piece clip manufactured without welds to help to eliminate the evils of corrosion for 40-150mm pipe sizes. They are easy to position and fit, even with existing pipework to provide a neater looking finished result. Designed without welds to help prevent rust.

Conforms to AS 2887:1993.

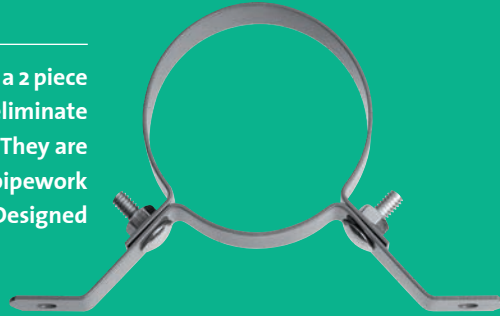

Step 1 – Two part clip for new and retro fit applications.



Step 2 – Position bracket and fasten to wall.



Step 3 – Place pipe into bracket base.



Step 4 – Secure front of the clips with bolt and nuts (supplied).

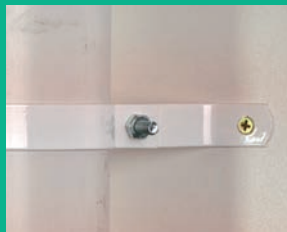

Step 5 – Fasteners neatly hidden behind pipe.



Australian made, Superior coatings.

| PRODUCT DESCRIPTION | | CODE |
|---|--------------------|------|
| STAND OFF CLIPS – GALVANISED & POWDERCOATED WHITE Stand Off PVC Clips | 40mm (25 per box) | 0120 |
| | 50mm (25 per box) | 0121 |
| | 65mm (25 per box) | 0122 |
| | 80mm (25 per box) | 0123 |
| | 90mm (25 per box) | 0126 |
| | 100mm (25 per box) | 0124 |
| | 150mm (10 per box) | 0125 |

INDUSTRIAL STAND OFF BRACKETS

In line with Abey's continuous product improvement program they are currently phasing out and re-engineering their welded products due to the inherent weakness and corrosion issues associated with welding. Their new Stand Off Bracket is pressed, has no welds, is stronger and offers greater rust resistance and longevity than welded brackets, especially useful in moist and highly corrosive environments. Insist on Abey and avoid the risks of inferior imports.



| PRODUCT DESCRIPTION | | CODE |
|---|------------------|------|
| NUT CLIP STAND OFF BRACKET (PRESSED) | M10 (25 per box) | 5160 |
| | M12 (25 per box) | 5168 |

INDUSTRIAL BOLTED CLIPS NUT CLIPS

The biggest difference plumbers may notice between the Abey product and imported clips is the welding. While both look similar, Abey's newest nut clips are no longer welded but machine pressed, which means they are stronger, more consistent better quality products, that fight the rust demons. Imported products are often welded by hand making their quality inconsistent. See instructional web video – www.abeytrade.com.au



Abey's Industrial Nut clips – are machine pressed and are available for:
✓ DWV ✓ Copper ✓ Galvanised ✓ HDPE pipe

For sizes ranging from 12 – 300mm diameter. A powder coating is applied to the galvanised clip to give extra corrosion protection.



Abey's manufacturing facility showing the powder coating operation.

INDUSTRIAL BOLTED CLIPS NUT CLIPS

| PRODUCT DESCRIPTION | | CODE | |
|---|---|--------------------|------|
| DWV PIPE NUT CLIPS – GALVANISED & POWDERCOATED WHITE DWV Pipe Nut Clips M10 | 40mm (25 per box) | 5170 | |
| | 50mm (25 per box) | 5171 | |
| | 65mm (25 per box) | 5172 | |
| | 80mm (25 per box) | 5173 | |
| | 100mm (25 per box) | 5174 | |
| | 150mm (10 per box) | 5175 | |
| | 225mm (Each) | 5280 | |
|  | 300mm (Each) | 5281 | |
| | DWV Pipe Nut Clips M12 | | |
| | 225mm (Each) | 5161 | |
| | 300mm (Each) | 5162 | |
| NUT CLIPS FOR COPPER PIPE – GALVANISED & POWDERCOATED BROWN Copper Pipe Nut Clips M10 | 15mm (25 per box) | 5165 | |
| | 20mm (25 per box) | 5177 | |
| | 25mm (25 per box) | 5178 | |
| | 32mm (25 per box) | 5179 | |
| | 40mm (25 per box) | 5180 | |
| | 50mm (25 per box) | 5181 | |
| | 65mm (25 per box) | 5182 | |
| | 75mm (25 per box) | 5183 | |
| | 100mm (25 per box) | 5184 | |
| | 200mm (Each) | 5163 | |
|  | Copper Pipe Nut Clips M12 | | |
| | 150mm (10 per box) | 5185 | |
| NUT CLIPS FOR HDPE PIPE – GALVANISED & POWDERCOATED BLACK HDPE Pipe Nut Clips M10 | 40mm (25 per box) | 5140 | |
| | 50mm (25 per box) | 5141 | |
| | 56mm (25 per box) | 5142 | |
| | 63mm (25 per box) | 5143 | |
| | 75mm (25 per box) | 5144 | |
| | 90mm (25 per box) | 5145 | |
| | 110mm (25 per box) | 5146 | |
| | 125mm (10 per box) | 5131 | |
| |  | 160mm (10 per box) | 5149 |
| | | 200mm (Each) | 5152 |
| | | 250mm (Each) | 5151 |
| | | 300mm (Each) | 5153 |
| HDPE Pipe Nut Clips M12 | | | |

INDUSTRIAL HANGING CLIPS

Faster, non welded for strength and greater corrosion resistance, made from high quality G2-227s galvanised steel to conform to AS/NZ building codes.

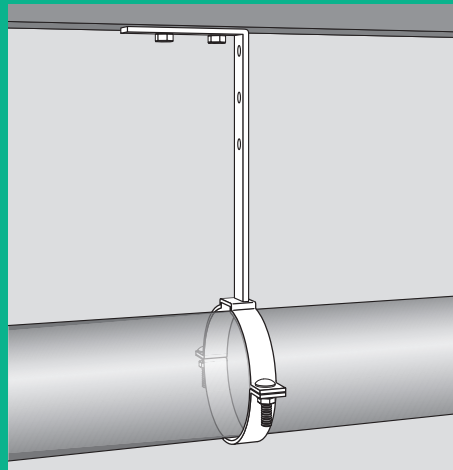
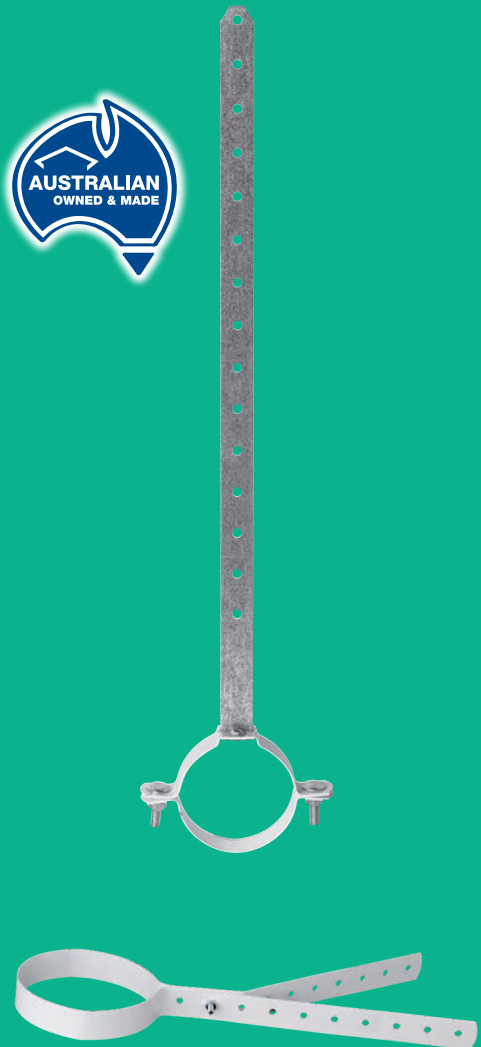

| PRODUCT DESCRIPTION | CODE |
|--|------|
| HANGING CLIPS FOR DWV 450MM SHANK – GALVANISED & POWDERCOATED | |
| 40mm (20 per box) | 0150 |
| 50mm (20 per box) | 0151 |
| 65mm (20 per box) | 0152 |
| 80mm (20 per box) | 0153 |
| 90mm (20 per box) | 0156 |
| 100mm (20 per box) | 0154 |
| INEXPENSIVE ADJUSTABLE PIPE HANGERS DWV | |
| 40mm (10 per pack) | 5250 |
| 50mm (10 per pack) | 5251 |
| 65mm (10 per pack) | 5252 |
| 80mm (10 per pack) | 5253 |
| 90mm (10 per pack) | 5254 |
| 100mm (10 per pack) | 5255 |

INDUSTRIAL ALL THREAD CLIPS

Abey industrial All Thread Clips are rated for industrial applications of up to 1500kg for PVC pipe. There are no welds and they are galvanised and powder coated to eliminate corrosion potential and conform to AS/NZ building codes. They also offer a unique feature for adjustment of pipe fall. See instructional web video – www.abeytrade.com.au



Step 1 – Trim All Thread to required length. Measure and mark off fall line and screw the first locating nut above this position.



Step 2 – Position bracket and swing lower section out of the way and fit pipe.



Step 3 – Secure the lower section with the hi-tensile, zinc plated bolts and nuts (supplied).



Step 4 – Fit remaining pipe and make any minor pipe fall adjustments prior to tightening off.

| PRODUCT DESCRIPTION | CODE |
|---|------|
| ALL THREAD CLIPS – GALVANISED & POWDERCOATED WHITE | |
| All Thread PVC Pipe Clips | |
| 40mm (25 per box) | 0170 |
| 50mm (25 per box) | 0171 |
| 65mm (25 per box) | 0172 |
| 80mm (25 per box) | 0173 |
| 100mm (25 per box) | 0174 |
| 150mm (10 per box) | 0175 |

INDUSTRIAL CLIPS ABEY PEAR CLIPS

Abey's Pear Clips are the quickest, safest, best value clips on the market. A quality, easy to use Pear Clip which reduces installation time. Once you've experienced Abey's unique 'snap lock' action, you'll never use ordinary pear clips again!



PRODUCT DESCRIPTION

CODE

PEAR CLIPS TO SUITE BSP (Fire Sprinklers)



| | |
|-------------------|-----|
| 20mm (75 per box) | P20 |
| 25mm (60 per box) | P25 |
| 32mm (50 per box) | P32 |
| 40mm (40 per box) | P40 |
| 50mm (30 per box) | P50 |
| 65mm (30 per box) | P65 |

PEAR CLIPS TO SUITE DWV Powder Coated White



| | |
|--------------------|-------|
| 50mm (30 per box) | P50C |
| 100mm (20 per box) | P100C |
| 150mm (10 per box) | P150C |
| 250mm (10 per box) | P250C |

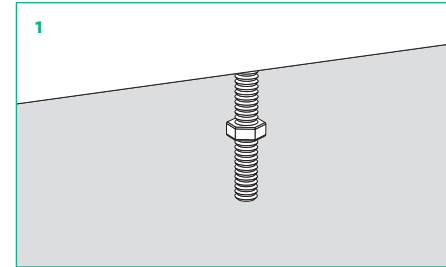

Step 1 – Trim All Thread to length and secure to anchor point. Spin on top nut.

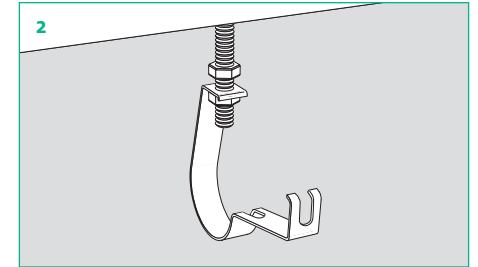

Step 2 – Slide pear clip over thread and attached second nut below clip, adjusting to required height. Do not tighten top nut, leave a gap of approximately 5mm.

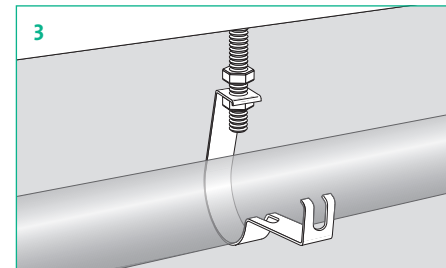

Step 3 – Hang pipe on bracket. Pear clip will hold pipe temporarily until fastened.

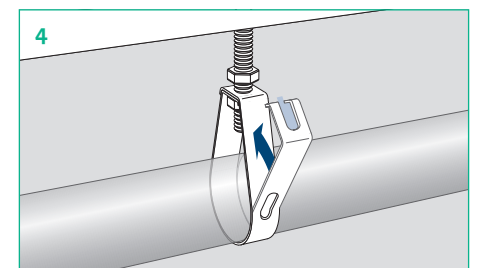

Step 4 – Simply push edge of pear clip upwards as shown. Clip will fit around bolt and snap into place locking shut.

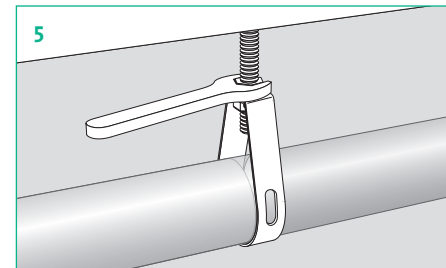

Step 5 – Tighten top nut to hold pear clip firmly.

Abey Pear Clips will support the pipe (as shown below) allowing any adjustments to be made prior to tightening. Once the pipe is correctly positioned, simply 'snap Lock' the Pear Clip shut and tighten the top nut.

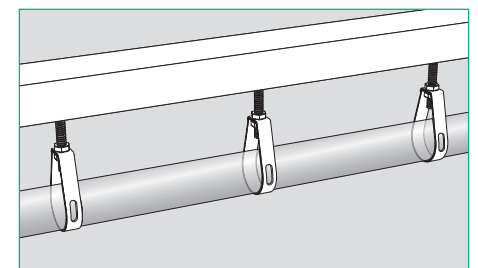
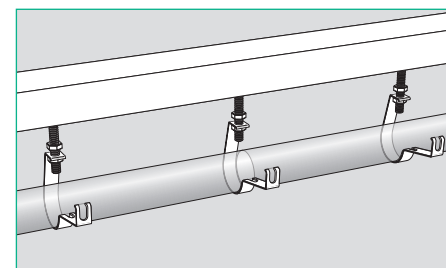

STANDARD PIPE CLIPPING

Abey have for over 60 years been 'The Tradesman's Choice' for quality plumbing products. A proud 100% family owned company, employing over 150 people locally, Abey's streamlined manufacturing facilities produce a huge range of precision engineered products for the building and plumbing industry, that are cost competitive against overseas imports.

For over five decades Abey have set the standards with their extensive range of high quality Australian Made G2-Z275 galvanised steel and powder coated Saddle Clips. Conforming to AS/NZ 3500 3.3.3, they offer the premium protection against electrolysis, corrosion and water hammer.



Quality Materials.



Locally Made = Jobs for Aussies.



National Distribution and Support.



Australian Made Quality.



SADDLE CLIPS

| PRODUCT DESCRIPTION | CODE |
|---|---------------------------------|
| SADDLE CLIPS FOR GALVANISED PIPE – GALVANISED Saddle Clips for Galvanised Pipe | DN15 ½" BSP (100 per box) 1400 |
| | DN20 ¾" BSP (100 per box) 1401 |
| | DN25 1" BSP (100 per box) 1402 |
| | DN32 1¼" BSP (100 per box) 1403 |
| | DN40 1½" BSP (50 per box) 1404 |
| | DN50 2" BSP (50 per box) 1405 |
| SADDLE CLIPS FOR PRESSURE PIPE – GALVANISED & POWDERCOATED WHITE Saddle Clips for Pressure Pipe | DN15 ½" (100 per box) 1421 |
| | DN20 ¾" (100 per box) 1422 |
| | DN25 1" (100 per box) 1423 |
| | DN32 1¼" (100 per box) 1424 |
| | DN40 1½" (50 per box) 1425 |
| | DN50 2" (50 per box) 1426 |
| HALF SADDLE CLIPS GALVANISED & NYLON COATED FOR COPPER PIPE Half Saddle Clips CU Coated | DN15 ½" (200 per box) 1476 |
| | DN20 ¾" (200 per box) 1477 |
| SADDLE CLIPS GALVANISED & NYLON COATED FOR COPPER PIPE Saddle Clips CU Coated | DN15 ½" (200 per box) 1467 |
| | DN18 5/8" (200 per box) 1468 |
| | DN20 ¾" (200 per box) 1469 |
| | DN25 1" (200 per box) 1470 |
| | DN32 1¼" (20 per box) 1471 |
| | DN40 1½" (20 per box) 1472 |
| CHROME PLATED SADDLE CLIPS FOR CHROME PIPE Saddle Clips for Chrome Pipe | DN15 ½" (100 per box) 1664 |
| | DN20 ¾" (100 per box) 1666 |

SADDLE CLIPS

| PRODUCT DESCRIPTION | CODE |
|--|--|
| COPPER SADDLE CLIPS FOR COPPER PIPE Copper Saddle Clips | DN6 ¼" (100 per box) 1681 |
| | DN8 5/16" (100 per box) 1682 |
| | DN10 3/8" (100 per box) 1683 |
| | DN15 ½" (200 per box) 1684 |
| | DN18 5/8" (200 per box) 1685 |
| | DN20 ¾" (200 per box) 1686 |
| | DN25 1" (200 per box) 1687 |
| POWDER COATED SADDLES FOR DWV – GALVANISED & POWDERCOATED WHITE DWV Saddle Clips | DN40 1½" (100 per box) 1706 |
| | DN50 2" (100 per box) 1707 |
| | DN65 2½" (50 per box) 1708 |
| | DN80 3" (50 per box) 1709 |
| | DN100 4" (50 per box) 1710 |
| | DN150 6" (10 per box) 1712 |
| Stainless Steel DWV Saddle Clips | DN100 4" Stainless Steel (50 per box) 1710S |
| SADDLES FOR DWV STAND OFF – GALVANISED & POWDERCOATED WHITE DWV Stand Off Clips | DN40 1½" (100) 1691 |
| | DN50 2" (100) 1692 |
| | DN65 2½" (50 per box) 1694 |
| | DN80 3" (50 per box) 1695 |
| | DN90 3½" (50 per box) 1696 |
| | DN100 4" (50 per box) 1693 |
| DOWNPIPE CLIPS/SADDLES | 75mm (20 per box) Galvanised & Powder Coated 1909 |
| | 90mm (50 per box) Galvanised & Powder Coated 1910/50 |
| | 90mm (20 per box) Stainless Steel 1910S |
| | 90mm (50 per box) Colorbond 1910C |

ABEY FANTASTIC PLASTIC PRODUCTS

Abey's 'Fantastic Plastic' range of plumbing products provide simple solutions to save you time, money and space. These 'best of breed' products have been selected from the world's best manufacturers to provide you quality plumbing solutions at the right price.



ABEY FANTASTIC PLASTIC PRODUCTS AIR ADMITTANCE VALVES (VENTAPIPE)

Abey's Ventapipe Air Admittance Valves are for use in above ground drainage systems to enable ventilating pipes to be terminated within the building. Easier, faster installations are gained, negating the need for roof penetrations. Conforms to AS 2887:1993, AS/NZ 4936:2002.

- ✓ Prevents the release of foul air
- ✓ Reduces risk of syphoning
- ✓ Can be used in most internal situations
- ✓ Used in both new and existing systems
- ✓ Allows for greater design flexibility
- ✓ Reduces material and labour costs
- ✓ Rigorously tested
- ✓ Will not unseal



As a Trap Vent

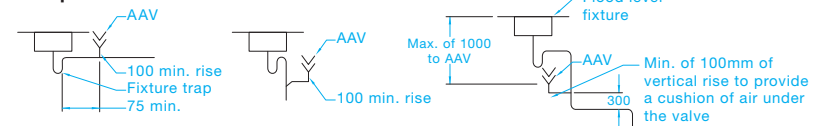



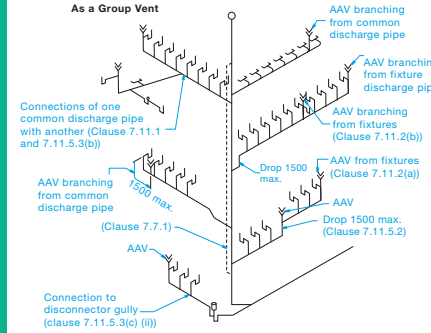

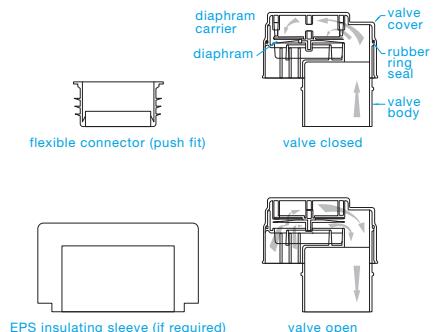

As a Group Vent



Ventapipe Air Admittance Valve



ABEY FANTASTIC PLASTIC PRODUCTS AIR ADMITTANCE VALVES & ALL ONE TRAPS

| PRODUCT DESCRIPTION | | CODE |
|---|---------|-------------|
| AIR ADMITTANCE VALVES (AAVS) Air Admittance Valve | 40/50mm | VPSFN-1.5-2 |
|  | | |
| Air Admittance Valve | 50mm | VP50 |
|  | | |
| Air Admittance Valve | 100mm | VP100 |
|  | | |
| ADJUSTABLE S&P TRAPS WITH AV S&P Trap with Air Admittance Valve | 40mm | SP40AV |
|  | | |
| S&P Trap with Air Admittance Valve | 50mm | SP50AV |
|  | | |
| TUBULAR SWIVEL TRAPS 1 ½" Tubular Swivel All One Trap NEW | | TP10 |
|  | | |
| 2" Tubular Swivel All One Trap with Dishwasher Connection NEW | | ZP10WM |
|  | | |

ABEY FANTASTIC PLASTIC PRODUCTS ALL-IN-ONE AAV SPEED TRAP

The unique design draws air through the valve and not through the water seal eliminating any gurgling for a quieter discharge



Extended universal dishwasher inlet with 1" BSP thread for easier fitting of outlet hose

Integrated AAV vents internally and eliminates the need for secondary ventilation and additional pipe fabrication

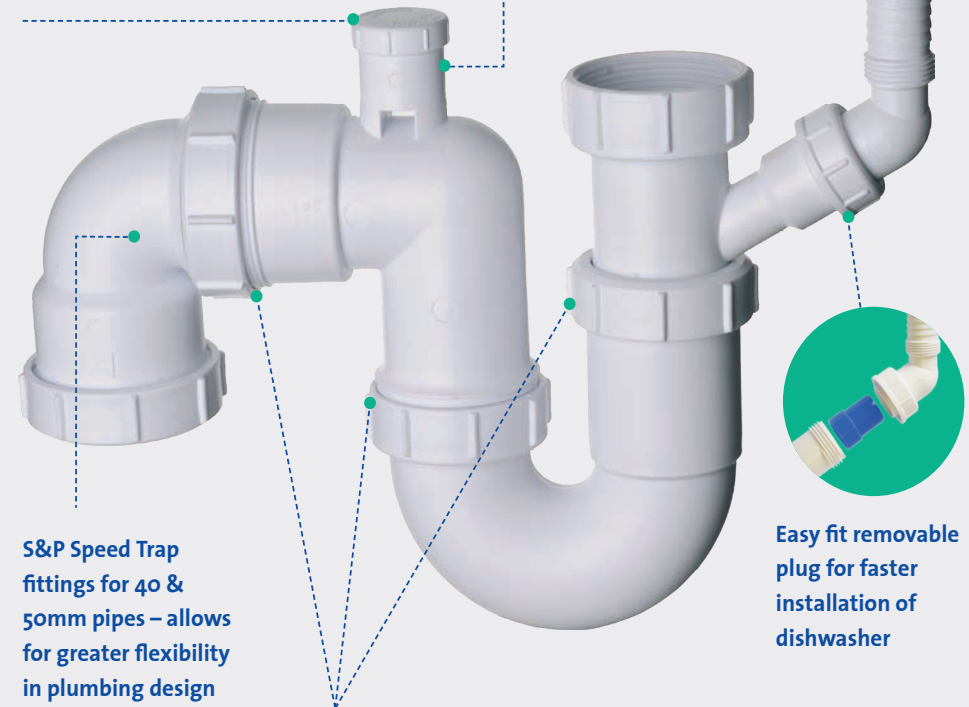







S&P Speed Trap fittings for 40 & 50mm pipes – allows for greater flexibility in plumbing design

Easy fit removable plug for faster installation of dishwasher

Adjustable fittings provide easy adjustability and watertight results



ABEY FANTASTIC PLASTIC PRODUCTS BOTTLE TRAPS & SELF CLOSING WASTE VALVES

| PRODUCT DESCRIPTION | CODE |
|---|---|
| BOTTLE TRAPS Reseal Adjustable Bottle Trap  | CP 32-40mm BT40A-CP |
| Bottle Trap with Anti-syphon Adjustable  | 40mm C10AV |
| Bottle Trap 350mm Pipe  | Chrome WC09 Black WC09-B Brushed Nickel WC09-BN |
| SELF CLOSING WASTE VALVES 1 1/2" BSP Inlet and Compression Outlet Self Sealing Trap NEW  | MACVALVE-2 |
| 90 degree Bend 1 1/2" Female inlet x 1 1/2" BSP Male Connector to suit MACVALVE-2 NEW  | T4U |
| 1 1/2" Universal Inlet & Outlet Self Sealing Trap NEW  | MACVALVE-5 |
| 2" Universal Inlet & Outlet Self Sealing Trap NEW  | MACVALVE-20 |



ABEY FANTASTIC PLASTIC PRODUCTS WC CONNECTORS

| PRODUCT DESCRIPTION | CODE |
|--|----------------------|
| WC CONNECTORS WC Straight Connector  | WC-CON1 |
| Offset Connector 20mm NEW  | 20mm offset WC-CON4 |
| Offset WC Connector  | 40mm offset WC-CON4A |
| WC Flexible Connector  | WC-F23R |
| Space Saving Pan Bend  | WC-CONQ |

ABEY FANTASTIC PLASTIC PRODUCTS
MACVALVE SELF-CLOSING WASTE VALVE

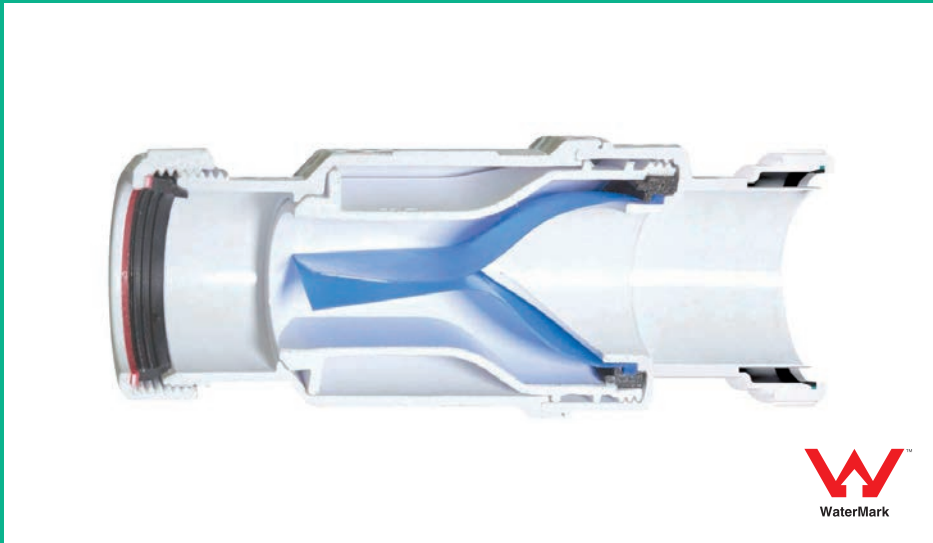

- ✓ Can be fitted in horizontal or vertical position.
- ✓ MacValve membrane opens under water pressure to allow discharge to flow freely and then closes to form a seal to prevent foul odour or sewer gas entering the building.
- ✓ MacValve can be fitted in installations where a nonreturn valve can be of benefit to the plumbing installation.
- ✓ MacValve can be used to take the discharge from a pressure relief valve on an unvented domestic hot water storage system. Please refer to guidance notes in approved Document G3 of the Building Regulations.
- ✓ MacValve having no water seal can never dry out through evaporation or lack of use of an appliance as the membrane remains sealed.
- ✓ MacValve is not recommended for use with shower trays unless there is access for maintenance.

ABEY FANTASTIC PLASTIC PRODUCTS
FLEXIBLE WASTE CONNECTORS

Abey offer a range of quality flexible connectors that are designed to help get you out of a hole. The ideal 'fix all' tool when all else fails, this range of products is a tool box for all plumbers and can help smooth out those hellish jobs that sometimes seem to go pear shaped.



FLEXIBLE WASTE TRAP CONNECTOR

- ✓ Flexible plastic fitting extends to 300mm
- ✓ Universal compression fitting
- ✓ Plain Spigot fitting



FLEXIBLE WASTE PIPE JOINER

- ✓ Available in 40mm and 50mm
- ✓ Flexible & extends to approx. 400mm
- ✓ Compression pipe end fittings





FLEXIBLE WASTE CONNECTOR

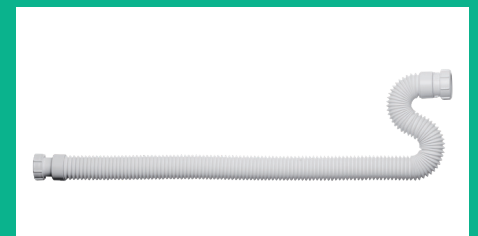



- ✓ Highly Flexible & extends to over one metre
- ✓ Female Fitting – Waste Connector
- ✓ Compression – Pipe Connector



ABEY FANTASTIC PLASTIC PRODUCTS FLEXIBLE WASTE CONNECTORS

| PRODUCT DESCRIPTION | | CODE |
|---|------|----------|
| FLEXIBLE CONNECTORS | 40mm | FLXT19UP |
| Flexible Waste Trap Connector | 50mm | FLXZ22UP |
|  | | |
| Flexible Waste Pipe Joiner | 40mm | FLXT19UU |
| | 50mm | FLXZ22UU |
|  | | |
| Flexible Waste Connectors | 40mm | FLXT40SU |
| | 50mm | FLXZ40SU |
|  | | |

ABEY FANTASTIC PLASTIC PRODUCTS ACCESSORIES

| PRODUCT DESCRIPTION | | CODE |
|---|-----------|-------|
| INCREASERS & REDUCERS | 50 x 40mm | T12C |
| Reducer | 40 x 50mm | T12E |
| Increaser | | |
|  | | |
| PLUG & WASTE EXTENSIONS | 50 x 20mm | EXT20 |
| Plug and Waste Extensions | 50 x 45mm | EXT45 |
| | 50 x 75mm | EXT75 |
|  | | |
| LAUNDRY ACCESSORIES | 70 Litre | LB70 |
| Laundry Bypass | | |
|  | | |
| Laundry Sink Overflow Pipe | | 6060 |
|  | | |
| Laundry Stainless Steel Basin Button | | 6061 |
|  | | |



ABEY FANTASTIC PLASTIC PRODUCTS
TRAPPED GULLIES

PRODUCT DESCRIPTION

CODE

TRAPPED GULLY FOR USE WITH SHEET FLOORING
 75mm Water Seal Trapped Gully: SS Clamp Ring
 & Cover **NEW**

TSG1SS



TRAPPED GULLIES FOR USE WITH TILED OR STONE FLOORS WHERE A WATERPROOF MEMBRANE IS REQUIRED

75mm Water Seal Trapped Gully 150mm SS Tile with Removable Cover (with securing screws) **NEW**

TSG1T6SS



ABEY FANTASTIC PLASTIC PRODUCTS
TRAPPED GULLIES

PRODUCT DESCRIPTION

CODE

TRAPPED GULLIES FOR USE WITH TILED OR STONE FLOORS WHERE A WATERPROOF MEMBRANE IS REQUIRED

75mm Water Seal Trapped Gully 150mm Square White ABS Tile with Removable Grid **NEW**

TSG1T6WH



75mm Water Seal Trapped Gully 125mm Diameter Polished SS Grating with Removable Grid **NEW**

TSG1-R125SS



GENERAL PLUMBING STAINLESS STEEL COVER PLATES

Abey produce a wide range of cover plates to suit most pipe sizes and rises.

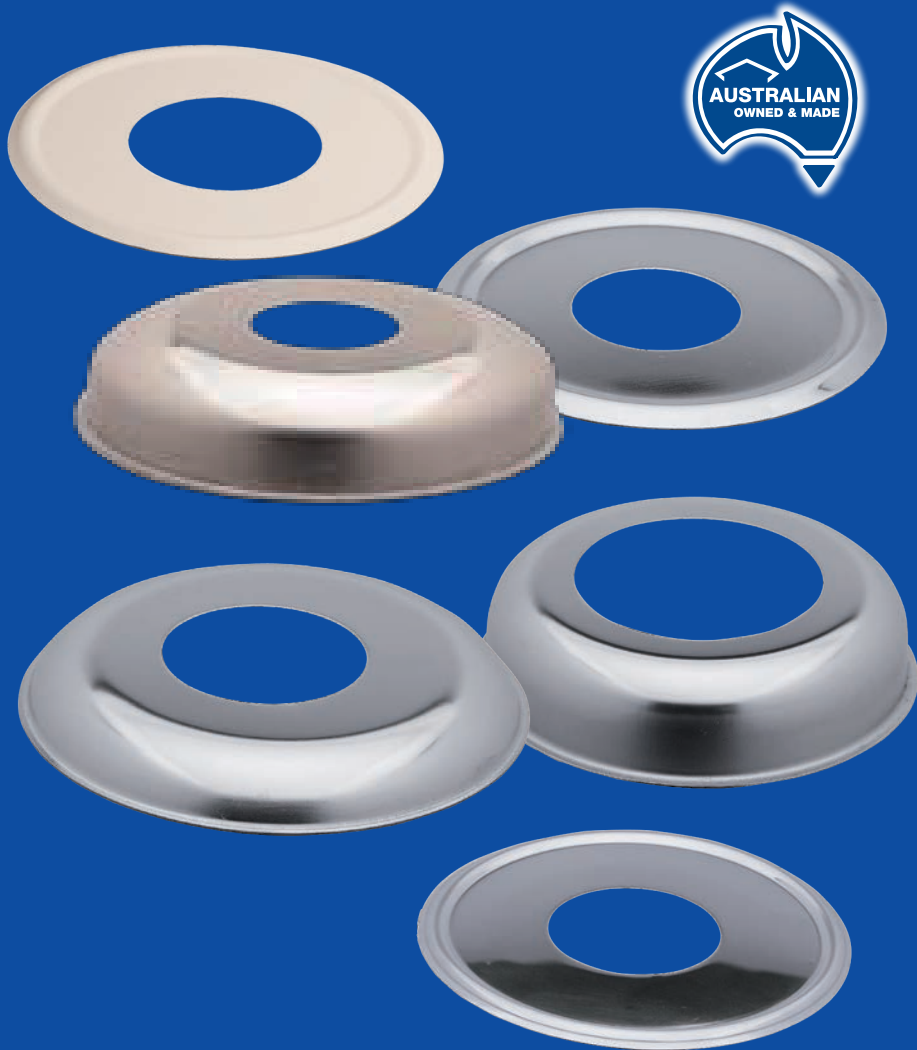





GENERAL PLUMBING STAINLESS STEEL COVER PLATES

| PRODUCT DESCRIPTION | CODE |
|--|------|
| Cover Plates for ½" BSP Pipe Flat | 2641 |
| Cover Plates for ½" BSP Pipe 9mm Rise | 2642 |
| Cover Plates for ½" BSP Pipe 12mm Rise | 2643 |
| Cover Plates for ½" BSP Pipe 15mm Rise | 2644 |
| Cover Plates for ½" BSP Pipe 21mm Rise | 2645 |
| Cover Plates for ¾" BSP Pipe Flat | 2673 |
| Cover Plates for ¾" BSP Pipe 9mm Rise | 2674 |
| Cover Plates for 1" BSP Pipe Flat | 2675 |
| Cover Plates for 1" BSP Pipe 18mm Rise | 2676 |
| Cover Plates for 1¼" BSP Pipe Flat | 2677 |
| Cover Plates for 1½" BSP Pipe Flat | 2647 |
| Cover Plates for 1½" BSP Pipe 18mm Rise | 2648 |
| Cover Plates for 2" BSP Pipe Flat | 2679 |
| Cover Plates for 2" BSP Pipe 18mm Rise | 2680 |
| Cover Plates for ½" BSP Pipe White Flat | 2703 |
| Cover Plates for ½" Copper Pipe Flat | 2661 |
| Cover Plates for ½" Copper Pipe 9mm Rise | 2662 |
| Cover Plates for ¾" Copper Pipe Flat | 2665 |
| Cover Plates for ¾" Copper Pipe 9mm Rise | 2666 |
| Cover Plates for 1" Copper Pipe Flat | 2667 |
| Cover Plates for 1" Copper Pipe 9mm Rise | 2668 |
| Cover Plates for 1¼" Copper Pipe Flat | 2669 |
| Cover Plates for 1¼" Copper Pipe 18mm Rise | 2670 |
| Cover Plates for 1½" Copper Pipe Flat | 2663 |
| Cover Plates for 1½" Copper Pipe 18mm Rise | 2664 |
| Cover Plates for 2" Copper Pipe Flat | 2671 |
| Cover Plates for 2" Copper Pipe 18mm Rise | 2672 |
| Cover Plates for 40mm PVC Pipe White Flat | 2693 |
| Cover Plates for 40mm PVC Pipe White 18mm Rise | 2694 |
| Cover Plates for 50mm PVC Pipe White Flat | 2695 |
| Cover Plates for 50mm PVC Pipe White 18mm Rise | 2696 |

ROOFING

Abey have a range of Roof Plumbing Products that have been designed and manufactured locally to meet the needs of plumbers, using the best quality products to assure compliance to local building codes and provide long lasting performance.

| PRODUCT DESCRIPTION | | CODE |
|--|---|---------|
| DOWNPIPE POPS ZINCALUME ROUND Downpipe Pops  | 50mm (20 per box) | 1952Z |
| | 65mm (20 per box) | 1953Z |
| | 75mm (20 per box) | 1944Z |
| | 90mm (20 per box) | 1955Z |
| | 100mm (20 per box) | 1946Z |
| | | |
| DOWNPIPE POPS ZINCALUME SQUARE Downpipe Pops  | 100 x 50mm (30 per box) | 1958Z |
| | 100 x 75mm (30 per box) | 1959Z |
| | 100 x 100mm (20 per box) | 1960Z |
| ZINC DOWNPIPE CLIPS ROUND Downpipe Clips  | 50mm (20 per box) | 1912Z |
| | 65mm (20 per box) | 1913Z |
| | 75mm (20 per box) | 1914Z |
| | 90mm (20 per box) | 1915Z |
| | 100mm (20 per box) | 1916Z |
| | | |
| DOWNPIPE CLIPS ZINCALUME SQUARE Downpipe Clips  | 100 x 50mm (25 per box) | 1918Z |
| | 100 x 75mm (25 per box) | 1919Z |
| DOWNPIPE CLIPS/SADDLES  | 75mm (20 per box) Galvanised & Powder Coated | 1909 |
| | 90mm (50 per box) Galvanised & Powder Coated | 1910/50 |
| | 90mm (20 per box) Stainless Steel | 1910S |
| | 90mm (50 per box) Colorbond | 1910C |

ROOFING

| PRODUCT DESCRIPTION | | CODE |
|---|-------------------|------|
| SINGLE SKIN FLUE ACCESSORIES – CRIMP BENDS 45 & 90 DEGREE Crimp Bends Galvanised  | 75mm (45°) | 2623 |
| | 75mm (90°) | 2633 |
| | 100mm (45°) | 2624 |
| | 100mm (90°) | 2634 |
| | 125mm (45°) | 2625 |
| | 125mm (90°) | 2635 |
| | 150mm (45°) | 2626 |
| | 150mm (90°) | 2636 |
| | 200mm (45°) | 2627 |
| | 200mm (90°) | 2637 |
| CHINA HAT COWLS – GALVANISED China Hat Cowls (with bird proofing)  | 75mm | 2501 |
| | 90mm | 2502 |
| | 100mm | 2503 |
| | 125mm | 2505 |
| | 150mm | 2507 |
| | 175mm | 2508 |
| | 200mm | 2509 |
| | 225mm | 2510 |
| | 250mm | 2511 |
| | 275mm | 2512 |
| 300mm | 2513 | |
| RAINHEADS – ZINCALUME Rainheads Z/A  | 200 x 175 x 200mm | 2541 |
| | 275 x 175 x 200mm | 2542 |
| | 400 x 175 x 200mm | 2543 |
| | 300 x 225 x 225mm | 2544 |
| | 500 x 225 x 225mm | 2545 |
| | 450 x 300 x 300mm | 2546 |
| 500 x 300 x 300mm | 2547 | |

TYPE "B" GAS VENT DURAVENT – THE ULTIMATE TWIN WALL FLUE

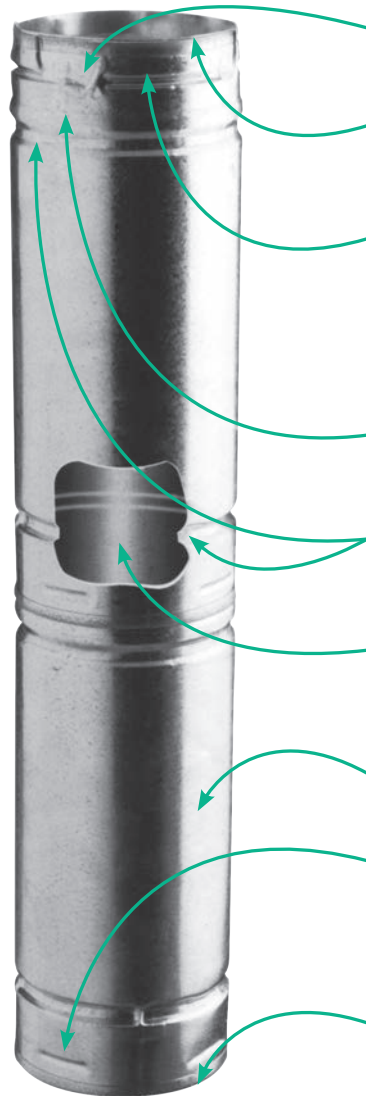

LOCKING CHANNEL

Provides firm, positive stop lock with female end.

MALE HEMMED EDGE

Easier to handle and allows for smooth, tight-fitting joints.

ENTERING CHANNEL

Ensures proper alignment and maintains correct spacing.

DIE-FORMED END

Means consistent fit, easy assembly, and contour swedged inner liner for condensation-free performance.

LINER SPACERS

Ensures inner liner and outer liner have proper spacing at all times.

ALUMINIUM INNER WALL

Allows for rapid warm-up for quick, strong venting and a corrosion-free environment for flue gases.

GALVANISED OUTER WALL

Offering life-long durability and added fire safety.

ROTATING SAFETY LOCK

Joints of pipe can be rotated and locked eliminating possible disassembly, yet they may be rotated out of lock manually when necessary for removal.

FEMALE HEMMED EDGE

For a smooth, tight fit. Recessed inner liner to avoid damage in handling.

TYPE "B" GAS VENT DURAVENT – THE ULTIMATE TWIN WALL FLUE

PRODUCT DESCRIPTION

CODE

DURAVENT TWIN SKIN GAS FLUEING

75mm Dia. Dura Pipes

75 x 1500mm

2000

75 x 900mm

2002

75 x 300mm

2003

100mm Dia. Dura Pipes

100 x 1500mm

2007

100 x 900mm

2009

100 x 300mm

2010

125mm Dia. Dura Pipes

125 x 1500mm

2014

125 x 900mm

2016

125 x 300mm

2017

150mm Dia. Dura Pipes

150 x 1500mm

2021

150 x 900mm

2023

150 x 300mm

2024

200mm Dia. Dura Pipes

200 x 1500mm

2020

200 x 900mm

2025

200 x 300mm

3308

250mm Dia. Dura Pipes

250 x 900mm

2026

250 x 450mm

3309

300mm Dia. Dura Pipes

300 x 900mm

3302

300 x 450mm

3310

DURAVENT TWIN SKIN GAS FLUEING

Dura Adjustable Pipes

75mm

2028

100mm

2029

125mm

2030

150mm

2031

200mm

2032

250mm

2033

300mm

3301



TYPE "B" GAS VENT DURAVENT – THE ULTIMATE TWIN WALL FLUE

| PRODUCT DESCRIPTION | CODE |
|---|------------------|
| DURAVENT 90° ELBOWS Dura 90° Elbows Adjustable  | 90° x 75mm 2035 |
| | 90° x 100mm 2036 |
| | 90° x 125mm 2037 |
| | 90° x 150mm 2038 |
| | 90° x 200mm 2039 |
| | 90° x 250mm 2040 |
| DURAVENT 45° ELBOWS Dura 45° Elbows Adjustable  | 45° x 75mm 2042 |
| | 45° x 100mm 2043 |
| | 45° x 125mm 2044 |
| | 45° x 150mm 2045 |
| | 45° x 200mm 2046 |
| | 45° x 250mm 2047 |
| | 45° x 300mm 3305 |
| DURAVENT DIVERTOR CONNECTORS Duravent Divertor Connectors  | 75mm 2049 |
| | 100mm 2050 |
| | 125mm 2051 |
| | 150mm 2052 |
| | 200mm 2053 |
| | 250mm 2054 |
| | 300mm 3307 |
| DURAVENT GAS COWLS Duravent Gas Cowls  | 75mm 2056 |
| | 100mm 2057 |
| | 125mm 2058 |
| | 150mm 2059 |
| | 200mm 2063 |
| | 250mm 2064 |
| | 300mm 3306 |
| DURAVENT TEES Duravent Tees  | 75mm 2080 |
| | 100mm 2081 |
| | 125mm 2082 |
| | 150mm 2083 |
| | 200mm 2084 |
| | 250mm 2085 |
| 300mm 3304 | |

TYPE "B" GAS VENT DURAVENT – THE ULTIMATE TWIN WALL FLUE

| PRODUCT DESCRIPTION | CODE |
|--|------------------|
| DURAVENT TEE CAPS Duravent Tee Caps  | 75mm 3000 |
| | 100mm 3001 |
| | 125mm 3002 |
| | 150mm 3003 |
| | 200mm 3004 |
| | 250mm 3005 |
| | 300mm 3007 |
| DURAVENT INCREASERS Duravent Increasers  | 75 x 100mm 2090 |
| | 75 x 125mm 2091 |
| | 75 x 150mm 2092 |
| | 100 x 125mm 2093 |
| | 100 x 150mm 2094 |
| | 125 x 150mm 2095 |
| | 150 x 200mm 2096 |
| | 175 x 200mm 2097 |
| 200 x 250mm 2098 | |
| 250 x 300mm 3303 | |
| DURAVENT CEILING RINGS Duravent Ceiling Rings  | 100mm 2302 |
| | 125mm 2303 |
| | 150mm 2304 |
| | 200mm 2306 |
| | 225mm 2307 |
| | 250mm 2308 |
| | 300mm 2310 |
| DURAVENT FLASHING CLIPS Duravent Flashing Clips  | 75mm 2321 |
| | 100mm 2322 |
| | 250mm 2328 |
| | 300mm 2329 |
| DURAVENT SOLID BRICK ELBOWS Solid Brick Elbows  | 450mm 1983 |
| | 600mm 1983L |

DIRECT VENT PRO DURAVENT – UNITIZED COAXIAL VENTING SYSTEM

Direct Vent Pro is a unitized, coaxial (concentric) venting system designed for use with direct vent gas heaters and fireplaces. Outer pipe brings combustion air to the appliance. Inner pipe exhausts flue gases to the outside. Gaskets or sealants not required.



Typical installations

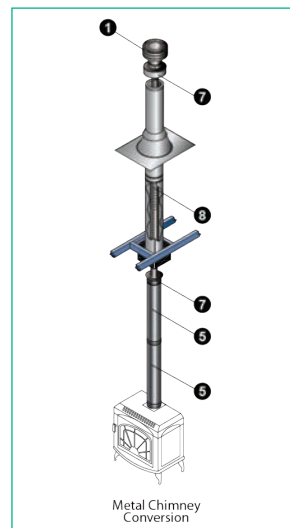
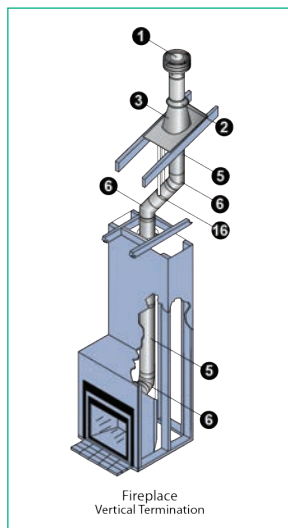
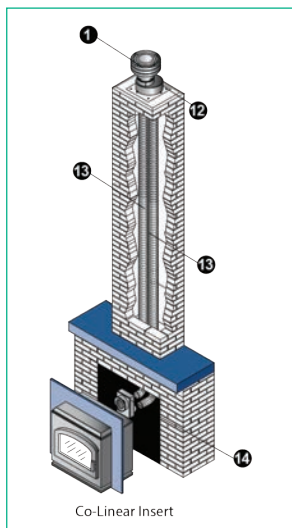

DIRECT VENT PRO DURAVENT – UNITIZED CO-AXIAL VENTING SYSTEM

| PRODUCT DESCRIPTION | | CODE |
|---|-----------------------|--------|
| PIPE LENGTHS – BLACK 100mm x 170mm Dia | 150mm Length | DV908 |
| | 225mm Length | DV907 |
| | 300mm Length | DV906 |
| | 600mm Length | DV904 |
| | 900mm Length | DV903 |
| | 1200mm Length | DV902 |
| ADJUSTABLE PIPE LENGTH – GALVANISED 100mm x 170mm Dia | 280mm x 432mm Length | DV911 |
| | | DV945G |
| 45° ELBOW – BLACK 100mm x 170mm Dia | | DV990G |
| | | DV984 |
| 90° ELBOW – BLACK 100mm x 170mm Dia | | DV991 |
| | | DV980 |
| TERMINATION CAPS – ALUMINIUM | Square Horizontal Cap | |
| | High Wind Cap | |
| | Low Profile Cap | |

GENERAL GAS FLUEING PRODCUTS

| PRODUCT DESCRIPTION | | CODE |
|--|---------------------------|----------|
| GAS FLEX FLUE KITS (TWO PLY) Contains 4m of pipe, 1 x cowl, 1 x 900mm solid gal sleeve, 1 x clamp * AGA Approved | 75mm | 75GF4K |
| | 100mm | 100GF4K |
| | 125mm | 125GF4K |
|  | | |
| GAS FLEX COMPONENTRY Abey Gas Flex Flues (Two Ply) Only sold in box Qty | 75 x 1500mm (6 per box) | 75GF |
| | 100 x 1500mm (6 per box) | 100GF |
| | 125 x 1500mm (6 per box) | 125GF |
|  | | |
| GAS FLEX LENGTHS OF 5 METRES <small>NEW</small> Duraconnect Gas Flex x 5m | 75 x 5m (2 per box) | 75GF/5M |
| | 100 x 5m (1 per box) | 100GF/5M |
| | 125 x 5m (1 per box) | 125GF/5M |
| | 150 x 5m (2 per box) | 150GF/5M |
|  | | |
| Gas Flex Flue Connectors Only sold in box Qty | To suit 75mm (6 per box) | 75FPA |
| | To suit 100mm (6 per box) | 100FPA |
| | To suit 125mm (6 per box) | 125FPA |
|  | | |
| GAS FLEX COWLS Gas Flex Cows | To suit 125mm (6 per box) | 125FPC |
| | To suit 150mm (each) | 2103 |
| | To suit 200mm (each) | 2063 |
| | To suit 250mm (each) | 2064 |
| | To suit 300mm (each) | 3306 |
|  | | |
| NB: The above 3 items can only be used in conjunction with each other and are non returnable | | |
| GAS COWLS SINGLE SKIN Gas Cowl for AC for Chimney Plate | 100mm | 2101 |
|  | | |

GENERAL GAS FLUEING PRODCUTS

| PRODUCT DESCRIPTION | | CODE |
|---|---|---------|
| GAS COWLS SINGLE SKIN Gas Cows for Galvanised | 75mm | 2113 |
| | 100mm | 2114 |
| | 100mm (10 per box) | 2114/10 |
| | 125mm | 2115 |
| | 125mm (6 per box) | 2115/6 |
| | 150mm | 2116 |
| | 180mm | 2117 |
| | 200mm | 2118 |
| | 225mm | 2119 |
| | 250mm | 2120 |
| | 300mm | 2121 |
| | 350mm | 2122 |
| | 400mm | 2123 |
| 450mm | 2124 | |
| 500mm | 2125 | |
| 550mm | 2126 | |
| 600mm | 2127 | |
|  | | |
| SINGLE SKIN GAS FLUE ACCESSORIES Galvanised Ceiling Rings | 75mm | 3401 |
| | 100mm | 3402 |
| | 125mm | 3403 |
| | 150mm | 3404 |
| | 200mm | 3406 |
|  | | |
| Galvanised Flashing Clips | 100mm (15 per box) | 2212 |
| |  | |
| Chimney Plate | | 2371 |
|  | | |
| Chimney Terminal Includes Cowl & Plate | | 2372 |
|  | | |

ROOFING RANGEHOOD FLUEING KITS & FLUEING PRODUCTS

Hygiene – In many homes kitchen rangehood exhausts are simply vented into the roof cavity. Over time, cooking gasses and oils expelled from a typical rangehood will build up on the surfaces inside the roof creating an unhygienic and unpleasant environment. Abey's Rangehood Flue Kits expel the cooking gasses and odours outside the house.



Fire Safety – The build up of grease and grime over years of cooking has the potential of being a fire hazard with the potential of fire spreading from an ignited cooking pan racing up the greasy rangehood igniting the built up grime. In situations where inferior plastic conduit may have been used, the plastic, if ignited will actually support combustion. Abey's Rangehood Flue Kits are of metal construction and will not support combustion.

Easy Installation – Abey Rangehood Kits contain all components necessary for easy installation. Available in all inclusive kit forms to suit most applications (vertical kits for metal & tile roofs and a horizontal kit for finishing on an external wall).



ROOFING RANGEHOOD FLUEING KITS & FLUEING PRODUCTS

| PRODUCT DESCRIPTION | | CODE |
|---|--|------------|
| RANGEHOOD FLUE Airflex | 100mm x 3m (12 per box) | 100AF3000 |
| | 100mm x 3m (66 per box) | 100AF3000B |
| | 125mm x 3m (8 per box) | 125AF3000 |
| | 125mm x 3m (45 per box) | 125AF3000B |
| | 150mm x 3m (6 per box) | 150AF3000 |
| | 150mm x 3m (28 per box) | 150AF3000B |
| RANGEHOOD FLUE KITS – VERTICAL To suit Steel Roof | 125mm Contains 3m of Airflex, Cowl, Roof Flashings for Steel Roof, Ceiling Ring and 6 Metres of Building Strapping. | RHVS5 |
| | 150mm Contains 3m of Airflex, Cowl, Roof Flashings for Steel Roof, Ceiling Ring and 6 Metres of Building Strapping. | RHVS6 |
| To suit Tile Roof | 125mm Contains 3m of Airflex, Cowl, Roof Flashing for Tile Roof, Ceiling Ring and 6 Metres of Building Strapping. | RHVT5 |
| | 150mm Contains 3m of Airflex, Cowl, Roof Flashing for Tile Roof, Ceiling Ring and 6 Metres of Building Strapping. | RHVT6 |
| RANGEHOOD FLUE KITS – HORIZONTAL | 125mm Contains 3m of Airflex, Ceiling Ring and External Wall Vent (Auto Closing). | RHH5 |
| | 150mm Contains 3m of Airflex, Ceiling Ring and External Wall Vent (Auto Closing). | RHH6 |

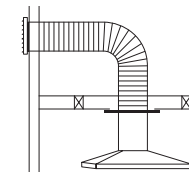
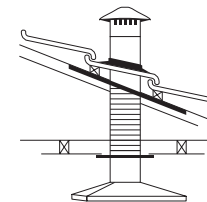
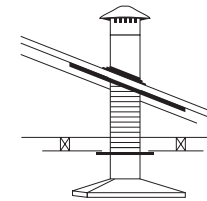

Victoria – Abey Head Office
Phone: 03 9747 7777

New South Wales
Phone: 02 8572 8572

Queensland
Phone: 07 3805 7000

Western Australia
Phone: 1800 809 143

South Australia
Phone: 1800 809 14

Email: mail@abey.com.au



abeytrade.com.au