

ASSEMBLY INSTRUCTION FOR EXC-750-SHELF

WARNING: Serious injury or death can be caused by toppling furniture

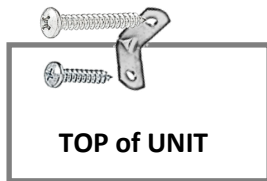

Help prevent tip-over:







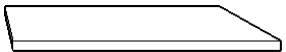

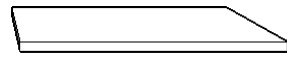
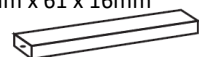
- Anchor this product to a wall or other suitable surface
- Check anchors regularly
- Avoid placing TVs on top unless the TV is also anchored
- Use drawer locks to prevent children climbing



When attaching unit to wall put safety bracket in middle of unit with 5/8 pan screw then 25mm pan head screw into wall. For plasterboard without a stud it is recommended to use a plug with screw (not provided).

PARTS IDENTIFICATION LIST

2 x TOP GABLES	 <p>966mm x 445mm x 16mm</p>	4 x ADJUSTABLE SHELVES	 <p>716mm x 445mm x 16mm</p>				
2 x BOTTOM GABLES	 <p>1035mm x 445mm x 16mm</p>	3 x FIXED SHELF	 <p>718mm x 445mm x 16mm</p>				
2 x BACKING BOARDS	<table border="1" style="width: 100%; border-collapse: collapse;"> <tr> <td style="text-align: center;">975mm x 744 x 3</td> <td style="text-align: center;">962mm x 744 x 3</td> </tr> <tr> <td style="text-align: center;">FOLD LINE TOP</td> <td style="text-align: center;">FOLD LINE BOTTOM</td> </tr> </table>	975mm x 744 x 3	962mm x 744 x 3	FOLD LINE TOP	FOLD LINE BOTTOM	1 x BOTTOM KICK	 <p>718mm x 61 x 16mm</p>
975mm x 744 x 3	962mm x 744 x 3						
FOLD LINE TOP	FOLD LINE BOTTOM						

NO	MODEL	DESCRIPTION	QTY	NO	MODEL	DESCRIPTION	QTY
1		CONFIRMAT SCREWS	20	5		SHELF PINS	16
2		CAPS	20	6		5/8 PANHEAD UNIT SCREWS	1
3		DOWELS	4	7		25mm PANHEAD WALLSCREWS	1
4		BACKING NAILS	75	8		"L" SAFETY BRACKET	1



MULTISTORE

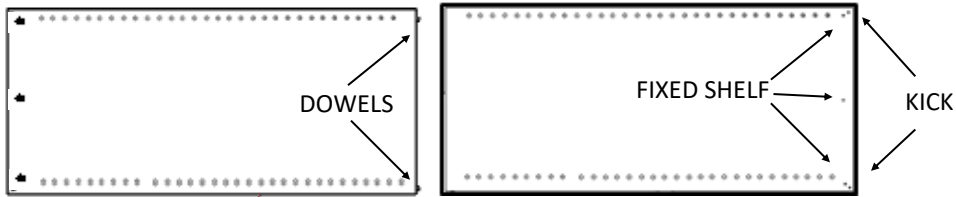

TAKE YOUR GABLES AND LAY THEM OUT FLAT, YOU SHOULD HAVE 2 X TOP & 2 X BOTTOM GABLES. INSERT YOUR WOOD DOWELS INTO 2 OF THE HOLES AND PUSH YOUR TOP INTO YOUR BOTTOM GABLE.

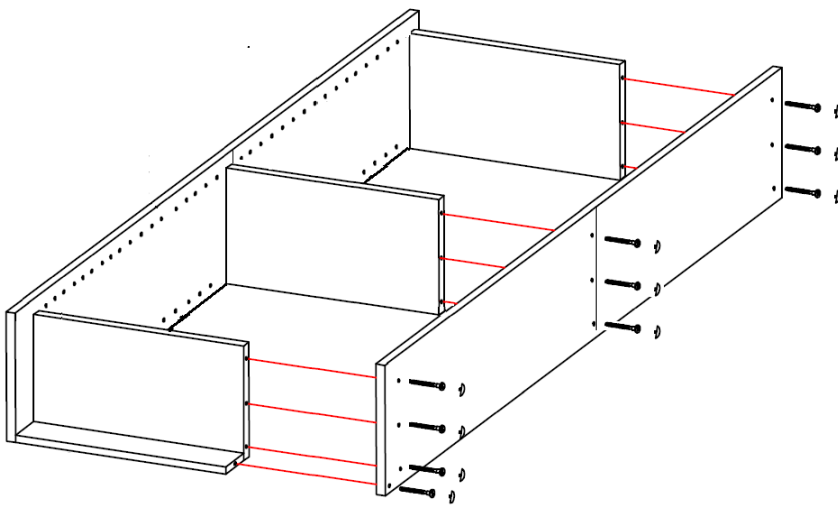

ALIGN YOUR SHELVES AND KICK TO THE LEFT-HAND GABLE, SCREW THEM INTO PLACE ATTACH YOUR RIGHT-HAND GABLE AND DO THE SAME.

FOLD OUT BOTH TOP AND BOTTOM BACKS
PROCEED TO NAIL THEM INTO POSITION
MAKING SURE YOU ARE SQUARE.

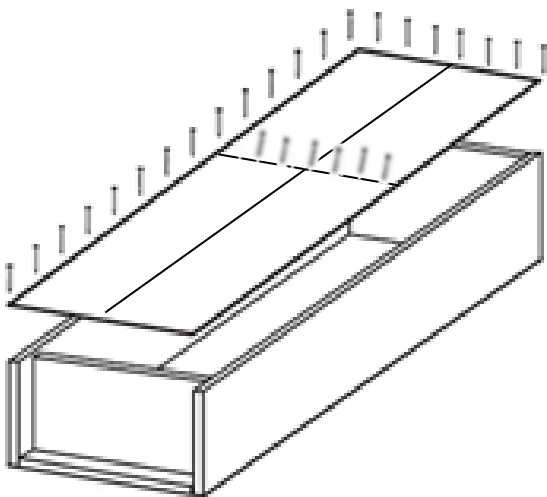

NEXT STEP:

GRAB THE SHELF PINS AND PUSH THEM INTO THE HOLES PROVIDED THESE WILL SUPPORT YOUR ADJUSTABLE SHELVING YOU MAY PUT THEM WHEREVER YOU LIKE.