

PRODUCT OVERVIEW

OCTOBER 2012



scy[✓]on™



TABLE OF CONTENTS

page 4:	Scyon™ overview
page 8:	Scyon™ Linea™ weatherboard product information
page 12:	Scyon™ Axon™ cladding product information
page 16:	Scyon™ Matrix™ cladding product information
page 20:	Scyon™ Stria™ cladding product information
page 23:	Scyon™ Secura™ exterior flooring product information
page 25:	Scyon™ Secura™ interior flooring product information
page 27:	Environmental information
page 28:	Usage safety information

SCYON™

The looks and the brains

Smarter building begins before a single hammer is lifted. It starts from the moment the building materials are designed and produced.

This new generation of sustainable building products feature the advanced cement composite Scyon™. Challenging conventional building methods, they ingeniously combine workability and durability with artful simplicity.

Not only is Scyon™ resistant to damage from termites, rot and fire¹, but it can also be gun nailed and is easy to cut – like timber.

From breathtaking facades, to resilient flooring, Scyon™ opens the door to a new generation of sustainable, efficient and durable products.



¹ When installed and maintained correctly and to the extent set out in James Hardie's published literature current at the time of installation.





THE WEATHERBOARD
THAT WEATHERS WELL

Building designed by Ellivo Architects

LINEA™ WEATHERBOARD

What is it?

A 16mm thick horizontal weatherboard with deep shadow lines. Scyon™ Linea™ weatherboard is the weatherboard that weathers well.

Where do you use it?

In residential applications wherever a contemporary design is required, including external walls in composite construction, upper-storey and ground-level extensions, and internal feature walls.

WHAT ARE THE KEY BENEFITS?

DESIGN OPTIONS. The 16mm thick profile creates consistent deep shadows. The range of corner finishing details – aluminium, PVC or Scyon™ Axent™ trim – means that a range of different looks can be achieved. The Linea™ window adaptor can be used for subtle window treatments or the Scyon™ Axent™ trim can provide a contrast. Face or concealed fixing rounds out the options.

EASY TO INSTALL. Linea™ weatherboards are back bevelled to sit flush with the stud. Paint application is fast because the pre-primed sheets mean less paint and time is needed to achieve a high-quality finish.

LOW MAINTENANCE. Scyon™ Linea™ weatherboard will maintain its integrity and general appearance significantly longer than timber. Some timber is susceptible to cracking in exterior applications, which in turn can lead to shrinking or warping. Scyon™ Linea™ will resist shrinking, swelling and cracking¹ to hold paint longer than wood, and can also be painted dark as well as light colours.

ENHANCES ENERGY EFFICIENCY. When Linea™ weatherboard is used with the right insulation (and in accordance with James Hardie's Wall System Thermal Performance Total R-Values Technical Supplement), an R-Value of up to 2.8 can be achieved for the wall.

EXTRA SECURITY. James Hardie provides a 25-year product warranty on Linea™ weatherboard.

MADE FROM SCYON.™ Linea™ weatherboard is made from Scyon,™ the advanced lightweight cement composite with heavy-duty performance. Not only is it resistant to damage from termites, rot and fire¹, but it can also be gun nailed and is easy to cut – like timber.



¹ When installed and maintained correctly and to the extent set out in James Hardie's published literature current at the time of installation.

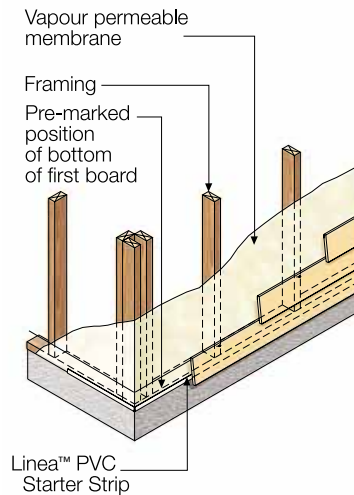

Linea™ weatherboard sizes

Product	Product Code	Length (mm)	Width (mm)	Thickness (mm)	End details	Coverage information			
						Effective cover (mm)	No. of planks/ metre height	Mass (kg/lin m)	Mass (kg/m ²)
150mm Linea™ weatherboard	PC: 403930	4,200	150	16	T&G	120	8.3	2.8	23.2
180mm Linea™ weatherboard	PC: 403912	4,200	180	16	T&G	150	6.7	3.4	22.7

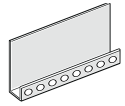
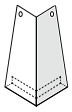
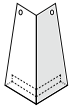

Linea™ weatherboard installation

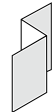
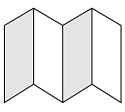
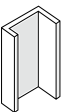

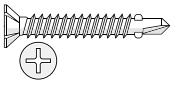
Accessories	Description
	Linea™ PVC Starter Strip Perforated PVC starter strip used to set out the bottom edge of Scyon™ Linea™ weatherboards at the correct angle. 25 per pack, 3,000mm lengths. PC: 305571
	Linea™ Aluminium Corner Soaker for 150mm wide boards Ready to paint aluminium external corner soaker for use with 150mm wide Scyon™ Linea™ weatherboards. 100 per box. PC: 305574
	Linea™ Aluminium Corner Soaker for 180mm wide boards Ready to paint aluminium external corner soaker for use with 180mm wide Scyon™ Linea™ weatherboards. 100 per box. PC: 305572
	Linea™ Aluminium External Slimline Boxed Corner Ready to paint aluminium extrusion to be used with Scyon™ Linea™ weatherboard to create external boxed corners. 5 per pack, 3,600mm lengths. PC: 305512

Accessories	Description
	Linea™ PVC Box Corner Z Flashing PVC Z flashing for use with Scyon™ Linea™ weatherboard in conjunction with Scyon™ Axent™ trim to form external corners. 25 per pack, 2,700mm lengths. PC: 305570
	Linea™ Aluminium Internal Corner Mould Ready to paint aluminium extrusion to be used with Scyon™ Linea™ weatherboard to create internal corners. 5 per pack, 3,600mm lengths. PC: 305511
	Linea™ Aluminium Universal Window Adaptor Ready to paint aluminium extrusion to be used adjacent to windows to finish the edge of Scyon™ Linea™ weatherboard. 5 per pack, 3,700mm lengths. PC: 305510
	James Hardie™ Joint Sealant* General purpose, paintable, exterior grade polyurethane joint sealant. 20 per box, 300ml cartridge. PC: 305534 <small>*Not to be used in fire applications</small>
	HardieBlade™ Saw Blade Ø185mm or Ø254mm diameter poly-diamond blade for fast and clean cutting of James Hardie fibre cement. 1 each. Ø185mm PC: 300660, Ø254mm PC: 303375
	HardieDrive™ Screw 32mm long Class 3 finish self-tapping wing-tipped screw for fastening to 0.8mm to 1.6mm BTM steel frames. 500 per box. PC: 305532

COMPONENTS NOT SUPPLIED BY JAMES HARDIE

Accessories	Description
	40 x 2.8mm fibre cement nails For concealed fixing Linea™ weatherboard and various accessories to timber framing as specified.
	Bullet head nails 60 x 3.15mm corrosion-resistant bullet head nails.

For more information about performance, installation, warranties and warnings: www.scyon.com.au



scyon™

AXON™

CLADDING

A PRISTINE LOOK
THAT LASTS

AXON™ CLADDING

What is it?

A vertically grooved cladding panel that looks sharp and smooth. Pre-primed and easy to install, Scyon™ Axon™ cladding is a pristine look that lasts.

Where do you use it?

In residential applications wherever a modern design is required, including external walls in composite construction, upper-storey and ground-level extensions, and internal feature walls.

WHAT ARE THE KEY BENEFITS?

SPEED. The stepped shi lap on the long edges of Axon™ cladding means sheets are easily installed. Paint application is fast because the pre-primed sheets mean less paint and time is needed to achieve a high-quality finish. Finally, sheets are sized to fit common wall frame sizes, which means less waste and cutting.

DESIGN OPTIONS. Select from two vertical groove width patterns and surface textures – both sharp and consistent. They provide a uniform look and are a great design alternative to typical horizontal features. The option of brad nailing minimises visual interruption. Axon™ cladding can also be used to add texture as an eave or soffit lining. Made from Scyon™, it will resist shrinking, swelling and cracking¹ to hold paint longer than wood, and can therefore be painted dark as well as light colours.

ENHANCES ENERGY EFFICIENCY. When Axon™ cladding is used with the right insulation (and in accordance with James Hardie's Wall System Thermal Performance Total R-Values Technical Supplement), an R-Value of up to 2.7 can be achieved for the wall.

MADE FROM SCYON™ Axon™ cladding is made from Scyon™, the advanced lightweight cement composite with heavy-duty performance. Not only is it resistant to damage from termites, rot and fire¹, but it can also be gun nailed and is easy to cut – like timber. Axon™ cladding has a 10-year product warranty when installed and maintained correctly.

¹ When installed and maintained correctly and to the extent set out in James Hardie's published literature current at the time of installation.

Axon™ cladding sizes

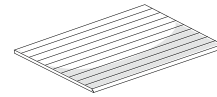

Pre-primed with vertical grooves. There is a shi lap edge joint along the two long edges, and square edges along the short edges. The grooves are nominally 2mm deep and 10mm wide. Sheet weighs approximately 12kg/m².

Product Code	Surface Texture	Groove Width (mm)	Length (mm)	Width (mm)	Thickness (mm)	Mass (kg)
403931	Smooth	133	2,450	1,200	9	36
404417	Smooth	400	2,450	1,200	9	36
403932	Smooth	133	2,750	1,200	9	40
404418	Smooth	400	2,750	1,200	9	40
403933	Smooth	133	3,000	1,200	9	44
404419	Smooth	400	3,000	1,200	9	44

Axon™ installation

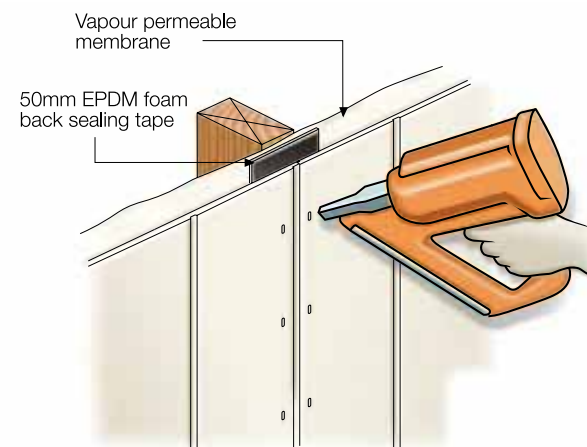

Accessories

Description

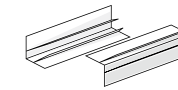

JH Aluminium Snap On Corner (2-piece sets)
Ready to paint aluminium extrusion set, to be used with Scyon™ Axon™ cladding, HardiePlank™ weatherboard and PrimeLine® weatherboard, at internal and external corner junctions to conceal the board edge.
5 sets per pack, 3,000mm lengths. PC: 305513

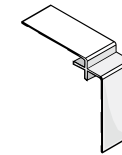

James Hardie™ 9mm Aluminium Internal Corner
Ready to paint aluminium extrusion, to be used with EasyLap™ panel and Scyon™ Axon™ cladding, at internal corner junctions to conceal the board edge.
5 per pack, 3,000mm lengths. PC: 305520

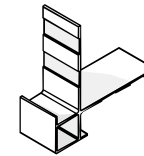

James Hardie™ 9mm Aluminium External Corner
Ready to paint aluminium extrusion, to be used with EasyLap™ panel and Scyon™ Axon™ cladding, at external corner junctions to conceal the board edge.
5 per pack, 3,000mm lengths. PC: 305521

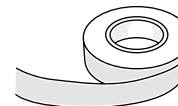

James Hardie™ 50mm wide Foam Back Sealing Tape
Self-adhesive foam tape to help improve water tightness with EasyLap™ panel and Scyon™ Axon™ cladding. It is applied under sheet joins to the vapour permeable membrane along the stud face. Roll, 25 metres long x 50mm wide x 1.6mm thick. PC: 304560



James Hardie™ Joint Sealant*
General purpose, paintable, exterior grade polyurethane joint sealant.
20 per box, 300ml cartridge. PC: 305534
*Not to be used in fire applications

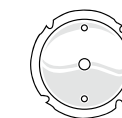

HardieBlade™ Saw Blade
Ø185mm or Ø254mm diameter poly-diamond blade for fast and clean cutting of James Hardie fibre cement. 1 each. Ø185mm PC: 300660, Ø254mm PC: 303375

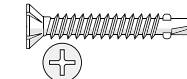

HardieDrive™ Screw 32mm long
Class 3 finish self-tapping wing-tipped screw for fastening to 0.8mm to 1.6mm BTM steel frames.
500 per box. PC: 305532

COMPONENTS NOT SUPPLIED BY JAMES HARDIE

Accessories

Description



Fibre cement nails
40 x 2.8mm corrosion-resistant fibre cement nail for fixing Axon™ cladding sheets onto timber stud frame.



ND 50mm Stainless Steel Brad Nail
14 gauge x 50mm ND 304 stainless steel nail for fixing Axon cladding sheets to a timber stud frame.

For more information about performance, installation, warranties and warnings: www.scyon.com.au

scyon™

MATRIX™

CLADDING

A COMMERCIAL LOOK
WITHOUT THE PRICE TAG



MATRIX™ CLADDING

What is it?

An exterior cladding system with a geometric, expressed-joint look. Fast and simple to install, Scyon™ Matrix™ cladding is the commercial look without the commercial price tag.

Where do you use it?

In residential and medium-density applications wherever a modern design is required, including external walls in composite construction, upper-storey and ground-level extensions, and internal feature walls.

WHAT ARE THE KEY BENEFITS?

SIMPLE TO INSTALL. Instead of needing the steel top hats associated with many commercial systems, Matrix™ cladding sheets are installed with Scyon™ cavity trim battens. The expressed joint is created easily using a 10mm packer. Sheets are sanded smooth and pre-primed for fast paint application and a high-quality finish.

DESIGN OPTIONS. Square and rectangular panels with an expressed joint mean a variety of looks can be created, from horizontal and vertical stripes to geometric patterns. Sanded sheets give a flat, smooth finish and digital printing can add even more design options. Matrix™ cladding's resistance to cracking, warping and swelling¹ means it can be painted both dark and light colours. The option of brad nailing minimises visual interruption. Matrix™ cladding may be specified for timber-framed or steel-framed structures.

DURABILITY. The Matrix™ cladding panels are sealed on all sides for durability and stability and the product has a 10-year product warranty when installed and maintained correctly.

ENHANCES ENERGY EFFICIENCY. When Matrix™ cladding is used with the right insulation (and in accordance with James Hardie's Wall System Thermal Performance Total R-Values Technical Supplement), an R-Value of up to 3.4 can be achieved for the wall.



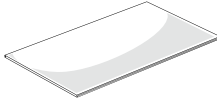

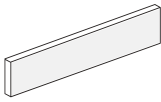
¹ When installed and maintained correctly and to the extent set out in James Hardie's published literature current at the time of installation.

Matrix™ cladding sizes					
	Product Code	Length (mm)	Width (mm)	Thickness (mm)	Mass (kg)
	403811	1,190	1,190	8	18
	403810	2,390	590	8	18
	403812	1,790	890	8	20
	404169	2,990	1,190	8	45

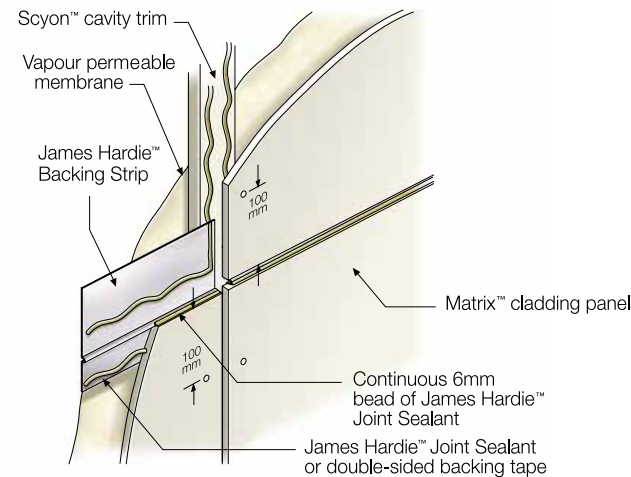
Scyon™ cavity trim					
	Product Code	Length (mm)	Width (mm)	Thickness (mm)	Mass (kg)
	403840	2,450	70	19	3.4

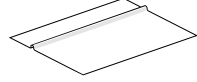
Matrix™ cladding installation

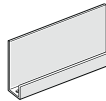
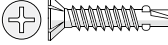

Accessories	Description
	James Hardie™ Backing Strip Weather seal at horizontal panel joints for use with ExoTec® façade panel and fixing system and Scyon™ Matrix™ cladding. Pack of 10. 1,190mm, 2,390mm and 2,990mm lengths. PC: 305557, PC: 305558, PC: 305559
	James Hardie™ Base Coat Water-resistant base coat compound used in conjunction with James Hardie™ Top Coat to create a seamless flush joint for Villaboard® lining. 15kg bag. PC: 304491
	James Hardie™ Façade Washers Façade washers used for exposed fastener fixing with ExoTec® façade panel and fixing system and Scyon™ Matrix™ cladding. Pack of 1,000. PC: 305565
	James Hardie™ Joint Sealant* General purpose, paintable, exterior grade polyurethane joint sealant. 20 per box, 300ml cartridge. PC: 305534 *Not to be used in fire applications
	HardieBlade™ Saw Blade Ø185mm or Ø254mm diameter poly-diamond blade for fast and clean cutting of James Hardie fibre cement. 1 each. Ø185mm PC: 300660, Ø254mm PC: 303375
	James Hardie™ 18mm PVC Cavity Vent Strip Perforated PVC extrusion used at the bottom of walls behind Scyon™ Matrix™ cladding. 25 per pack, 3,000mm long. PC: 305555
	HardieDrive™ Screw 40mm long Class 3 finish self-tapping wing-tipped screw for fastening to 0.8mm to 1.6mm BTM steel frames. 500 per box PC: 305533

COMPONENTS NOT SUPPLIED BY JAMES HARDIE

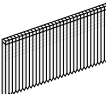
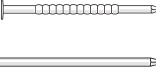
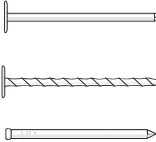
Accessories	Description
	C25 Stainless Steel Brad Nails C25 16 gauge 304 stainless steel brad nails used with James Hardie™ Joint Sealant for fixing Matrix™ cladding panels to the Scyon™ cavity trim. Pack of 2,000 includes fuel cell.
	Gun nail trim to frame 2.8 x 65mm long nail or 75 x 2.8mm D or round head galvanised smooth shank nail used to fix Scyon™ cavity trim to timber stud. Min, Class 3.
	Nails to fix panel to cavity trim 2.8 x 30mm galvanised nail, 2.6 x 32mm galvanised or stainless steel twist shank nail. Nail head must be a minimum round head diameter of 5.3mm, 25mm DA stainless steel Brad Nail for fixing Matrix™ panels to Scyon™ cavity trim.

For more information about performance, installation, warranties and warnings: www.scyon.com.au

CLASSIC APPEAL WITH
MODERN METHODS



STRIA™ CLADDING

What is it?

A wide cladding board with a 15mm horizontal and vertical joint that has the classic appeal of decorative render. Pre-primed and easy to install, Scyon™ Stria™ cladding is the fast way to achieve a timeless look, and that's smarter construction.

Where do you use it?

In residential and medium density applications wherever a classic yet contemporary design is required, including external walls in full wrap or composite construction, upper-storey and ground-level extensions, and internal feature walls.

WHAT ARE THE KEY BENEFITS?

SPEED. This is the fast way to create a modern yet classic look. Instead of laying bricks, rendering, scoring and painting (with all the associated mess and scheduling of different trades), Stria™ cladding has a simple, speedy installation method. Once the first board is fixed level, the shiplapped joint on the next extra-wide, 4.2m long board is fixed on top of the previous board and can be joined on or off stud.

DESIGN OPTIONS. The two board widths, together with the range of corner finishing details – aluminium, mitred or Scyon™ Axent™ trim – allows a range of different looks to be achieved. For example, easy-to-cut mitred corners mean that horizontal lines wrap the building seamlessly. Alternatively, Scyon™ trim can provide a contrast. Plus, a vertical flashing stop provides a 15mm vertical groove to match the horizontal for a more geometric treatment.

LOW MAINTENANCE. Stria™ cladding will maintain its integrity and general appearance significantly longer than timber. Some timber is susceptible to cracking in exterior applications, which in turn can lead to shrinking or warping. Stria™ cladding will resist shrinking, swelling and cracking¹ to hold paint longer than wood, and can also be painted dark as well as light colours.

ENHANCES ENERGY EFFICIENCY. When Stria™ cladding is used with the right insulation (and in accordance with James Hardie's Wall System Thermal Performance Total R-Values Technical Supplement), an R-Value of up to 2.7 can be achieved for the wall.

EXTRA SECURITY. James Hardie provides a 25-year product warranty on Stria cladding.

MADE FROM SCYON.™ Stria™ cladding is made from Scyon,™ the advanced lightweight cement composite with heavy-duty performance. Not only is it resistant to damage from termites, rot and fire¹, but it can also be gun nailed² and is easy to cut – like timber.

¹ When installed and maintained correctly and to the extent set out in James Hardie's published literature current at the time of installation.

² Can be gun nailed for face fixing only.

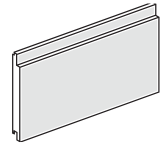
Stria™ cladding size									
Product	Product Code	Size (nominal)				Coverage information			
		Length (mm)	Width (mm)	Thickness (mm)	Effective cover (mm)	No. of boards/ metre height	Mass (kg/lin m)	Mass (kg/m²)	Pallet weight (kg)
	404063	4,200	325	14	300	3.3	5.2	17.3	1,310 (60/pack)
	404413	4,200	405 NEW	14	380	2.6	6.6	17.3	1,127 (40/pack)

Stria™ cladding installation

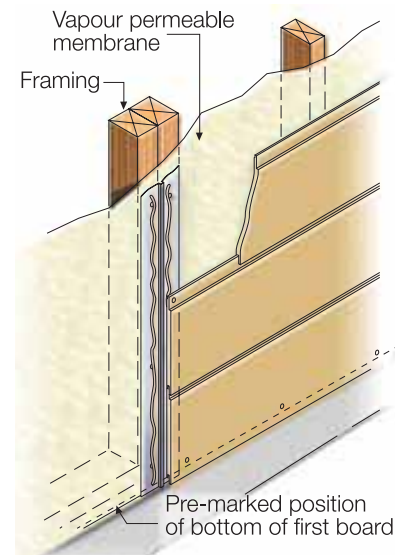

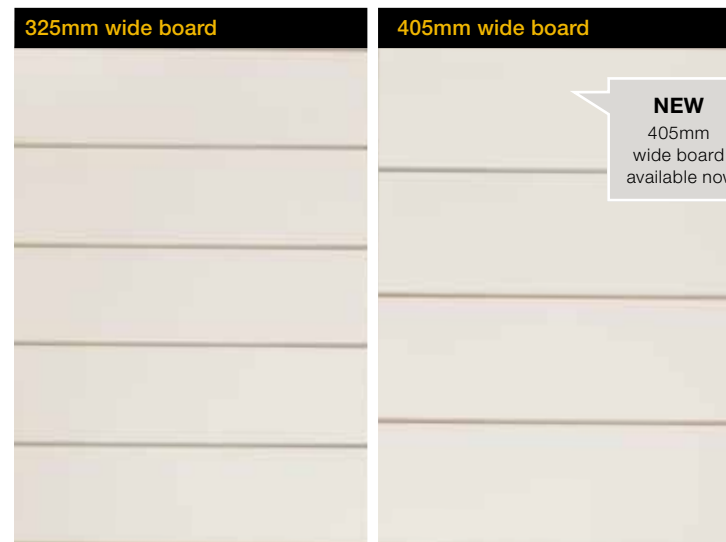

NOTE
Ensure each board is level and the height of each row of boards is kept the same.

For more information about performance, installation, warranties and warnings: www.scyon.com.au

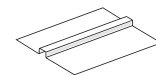
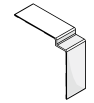
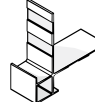
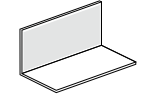

Accessories

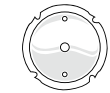
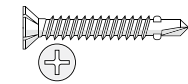
Accessories	Description
	Stria™ Vertical Flashing Stop For use with Scyon™ Stria™ cladding behind boards at vertical joints. 5 per pack, 3,000mm lengths. PC: 305547
	Stria™ Aluminium Internal Corner Ready to paint aluminium extrusion to be used with Scyon™ Stria™ cladding to create internal corners. 5 per pack, 3,000mm long. PC: 305518
	Stria™ Aluminium External Box Corner Ready to paint aluminium extrusion to be used with Scyon™ Stria™ cladding to create external boxed corners. 5 per pack, 3,000mm long. PC: 305519
	James Hardie™ 75x75mm Colorbond® Corner Flashing Colorbond® corner flashing for use behind cladding at internal and external corners. 5 per pack, 3,000mm lengths. PC: 305564
	James Hardie™ Joint Sealant* General purpose, paintable, exterior grade polyurethane joint sealant. 20 per box, 300ml cartridge. PC: 305534 <small>*Not to be used in fire applications</small>
	HardieBlade™ Saw Blade Ø185mm or Ø254mm diameter poly-diamond blade for fast and clean cutting of James Hardie fibre cement. 1 each. Ø185mm PC: 300660, Ø254mm PC: 303375
	HardieDrive™ Screw 32mm long Class 3 finish self-tapping wing-tipped screw for fastening to 0.8mm to 1.6mm BTM steel frames. 500 per box. PC: 305532

COMPONENTS NOT SUPPLIED BY JAMES HARDIE

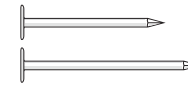
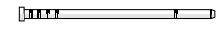
Accessories	Description
	40 and 50 x 2.8mm fibre cement nails Minimum Class 3 40mm for concealed fixing. 50mm for face fixing.
	ND or DA 50mm Stainless Steel Brad Nail 14 gauge x 50mm ND or DA stainless steel nail for an alternative to fixing Scyon™ Stria™ cladding to frame. Two per board and suitable up to N3 only. Refer to tables 1 and 2 in the Scyon™ Stria™ cladding installation manual.



SECURA™

EXTERIOR
FLOORING

PEACE OF MIND
THE EASY WAY



SECURA™ EXTERIOR FLOORING

What is it?

An external structural flooring substrate for ceramic tile finishes over timber or lightweight steel floor joists. Simple and fast to install, Scyon™ Secura™ exterior flooring helps give you peace of mind against moisture damage to balconies.

Where do you use it?

As an external substrate for tiled residential balconies and as an alternative to particle board, plywood or compressed fibre cement.

WHAT ARE THE KEY BENEFITS?

SECURITY. Scyon™ Secura™ exterior flooring is sealed on all sides with an advanced polymer coating that helps protect the board from moisture-related problems. A topcoat on the surface of the board provides good adhesion. The mesh reinforcement on the underside enhances the heavy-duty performance of Scyon™, adding extra strength and impact resistance to deliver a suitable external residential flooring substrate.

EASY TO INSTALL. At about 40kg and 2,700mm long by 600mm wide, Secura™ exterior flooring is about 15% lighter than compressed sheet (per square metre) and can be tucked under the arm and carried like a large surfboard (by two people). It's also tongue and grooved, which delivers engineered joints and eliminates the need for timber trimmers under these joints.

SPEED. For balconies that aren't over habitable rooms – verandas for example – no additional waterproofing membrane is needed once Secura™ exterior flooring is installed². For balconies over habitable rooms, a waterproofing system needs to be applied.

MADE FROM SCYON™. Secura™ exterior flooring is made from Scyon™, the advanced lightweight cement composite with heavy-duty performance. Not only is it resistant to damage from termites, rot and fire¹, but it can also be gun nailed and is easy to cut – like timber.

Secura™ exterior flooring

Product	Description
	Size: 19 x 600 x 2,700mm Approx. mass: 40kg PC: 404050

Secura™ exterior fastener layout

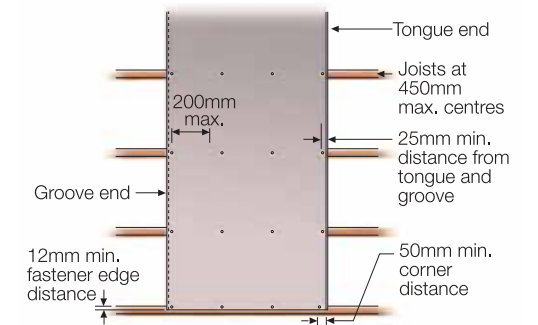

Accessories Description

	James Hardie™ Joint Sealant* General purpose, paintable, exterior grade polyurethane joint sealant. 20 per box, 300ml cartridge. PC: 305534 <small>*Not to be used in fire applications</small>
	HardieBlade™ Saw Blade Ø185mm or Ø254mm diameter poly-diamond blade for fast and clean cutting of James Hardie fibre cement. 1 each. Ø185mm PC: 300660, Ø254mm PC: 303375
	HardieDrive™ Screw 40mm long Class 3 finish self-tapping wing-tipped screw for fastening to 0.8mm to 1.6mm BTM steel frames. 500 per box PC: 305533

COMPONENTS NOT SUPPLIED BY JAMES HARDIE

Accessories	Description
	Nails 50 x 2.8mm corrosion-resistant fibre cement nails. 50mm corrosion-resistant D Head gun nails.

For more information about performance, installation, warranties and warnings: www.scyon.com.au

¹ When installed and maintained correctly and to the extent set out in James Hardie's published literature current at the time of installation.

² A priming coat is recommended to be applied over all sheets before tiling, refer to the manual.

TOP PROTECTION ON ALL INTERIOR FLOORS



SECURA™ INTERIOR FLOORING

What is it?

A heavy-duty but lightweight structural flooring substrate that does double duty – it can be easily used for tile, vinyl and carpet finishes over timber or steel floor joists in both residential general interiors and wet areas. Simple and fast to install, Scyon™ Secura™ interior flooring is the easiest way to get top protection against moisture damage to all interior floors.

Where do you use it?

As a substrate for direct fixing of tiles, vinyl and carpet in residential floors and wet areas, as an alternative to particle board, plywood or compressed fibre cement.

WHAT ARE THE KEY BENEFITS?

SPEED. Secura™ interior flooring is 15% lighter per square metre than conventional 15mm compressed fibre cement, which makes it easier to handle. And because it's made from Scyon™, there's no need for pre-drilling and screwing. All told it can be up to 40% faster to install than compressed.

NO FUSS. The tongue of commonly available 19mm timber sheet flooring can be inserted into the groove of the Secura™ interior flooring, eliminating the need for a trimmer at this joint. The groove of the Scyon™ Secura™ flooring must have James Hardie™ joint sealant applied into the groove before inserting the tongue of the 19mm timber sheet flooring. The moisture-resistant sealer on all sides combined with the moisture-resistant properties of the Scyon™ material removes the need for full floor waterproofing outside enclosed shower areas. And unlike some timber products, tiles and vinyl can be directly fixed without the need for an underlay sheet.

SECURITY. Secura™ interior flooring is resistant to damage from moisture, so if rain holds you up during construction and the roof's not yet on², the product won't need replacing or sanding because it's warped and twisted, like some timber products¹. This resistance to moisture damage also means that if there is a waterproofing failure some time in the future, then the Secura™ interior flooring will continue to perform, even if it gets wet. The strong, no-squeak feel of Secura™ interior flooring also gives a solid impression without the weight and cost of concrete. Secura™ interior flooring has a 10-year product warranty¹.

MADE FROM SCYON™ Secura™ interior flooring is made from Scyon™, the advanced lightweight cement composite with heavy-duty performance. Not only is it resistant to damage from termites, rot and fire¹, but it can also be gun nailed and is easy to cut – like timber.

¹ When installed and maintained correctly and to the extent set out in James Hardie's published literature current at the time of installation.

² Exposure to the elements should not be longer than three months.

Secura™ interior flooring

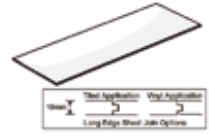

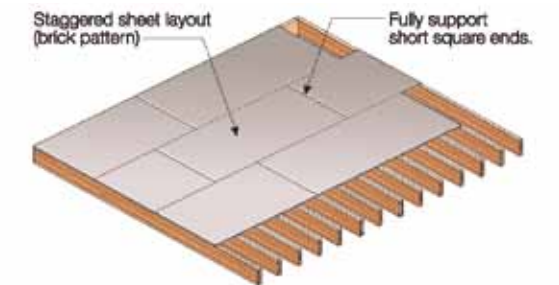

Product	Description
	Size: 19 x 600 x 2,700mm Approx. mass: 40kg per sheet. PC: 404173

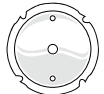
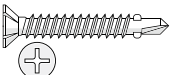

Accessories

Accessories	Description
	James Hardie™ Joint Sealant* General purpose, paintable, exterior grade polyurethane joint sealant. 20 per box, 300ml cartridge. PC: 305534 <small>*Not to be used in fire applications</small>
	HardieBlade™ Saw Blade Ø185mm or Ø254mm diameter poly-diamond blade for fast and clean cutting of James Hardie fibre cement. 1 each. Ø185mm PC: 300660, Ø254mm PC: 303375
	HardieDrive™ Screw 40mm long Class 3 finish self-tapping wing-tipped screw for fastening to 0.8mm to 1.6mm BTM steel frames. 500 per box PC: 305533

COMPONENTS NOT SUPPLIED BY JAMES HARDIE

Accessories	Description
	Nails 50 x 2.8mm corrosion-resistant fibre cement nails. 50mm corrosion-resistant D Head gun nails.
	Screws N° 8 x 40mm corrosion-resistant self-embedding head for screwing to timber.
	QuikDrive Collated Screw 42mm long Class 3 screw for fixing to 0.8–1.6mm BMT steel framing. Part No. CBSDG158SA
	Construction Adhesive Suitable construction adhesive for gluing sheets to floor frame.

For more information about performance, installation, warranties and warnings: www.scyon.com.au



Environmental impact

James Hardie is a longstanding industry innovator, and works consistently to improve the sustainability of its products and manufacturing operations.

The environmental impact of James Hardie® products can be viewed from the following perspectives.

What's the impact of manufacturing Scyon™ products?

Scyon™ is made from benign raw materials low in toxicity:

- Cellulose fibre – unbleached pine wood pulp from sustainable plantation timbers (*Pinus radiata*)
- Ordinary Portland cement
- Ground sand*
- Small amounts of additives as required for specific product properties
- Water.

Scyon™ products are low in embodied energy relative to many other building products like masonry and concrete.

What's the impact of construction that uses Scyon™ products?

Scyon™ products are easy to incorporate into practical building systems that touch the earth lightly.

What's the impact of using Scyon™ products, over the life of a building?

Scyon™ products are very durable and low maintenance which helps create buildings low in lifetime energy consumption.

What's the impact on people living and working in buildings made from Scyon™ products?

Used in the right design, Scyon™ products can be used to create energy efficient and thermally comfortable buildings in any Australian climate.

Scyon™ products are low in volatile organic compounds (VOCs).

*Please read the Best Practice Guide to working safely with fibre cement products on any product page at www.scyon.com.au or www.jameshardie.com.au

Work safely

James Hardie® products contain sand, a source of respirable crystalline silica, which is considered by some international authorities to be a cause of cancer from some occupational sources.

Breathing excessive amounts of respirable silica dust can also cause a disabling and potentially fatal lung disease called silicosis, and has been linked with other diseases.

Some studies suggest smoking may increase these risks. During installation or handling:

1. Work in outdoor areas with ample ventilation.
2. Minimise dust when cutting by using either a 'Score and Snap' knife, fibre cement shears or, where this is not feasible, use a HardieBlade™ Saw Blade and dust-reducing circular saw attached to a HEPA vacuum.
3. Warn others in the immediate area to avoid breathing dust.
4. Wear a properly fitted, approved dust mask or respirator (for example, P1 or P2) in accordance with applicable government regulations and manufacturer instructions to further limit respirable silica exposures. When cleaning up, use HEPA vacuums or wet clean-up methods. Never dry sweep.

For further information about performance, installation, warranties and warnings, refer to our installation instructions, Material Safety Data Sheets and our guide to safe handling at: www.jameshardie.com.au or www.scyon.com.au

*Please read the Best Practice Guide to working safely with fibre cement products on any product page at www.scyon.com.au or www.jameshardie.com.au



BUILDING SIMPLICITY

scyonTM



Ask James Hardie™
Call 13 11 03
www.jameshardie.com.au

scyon™

The culmination of years of innovative research and development, Scyon's™ resilient makeup challenges conventional building methods in a range of steadfast products. James Hardie™ is committed to the sustainable production of building materials for a tougher and greener tomorrow.

