

ozito

CEMENT MIXER

120L 550W

INSTRUCTION MANUAL

SPECIFICATIONS

Motor:	550W, 0.7HP
Input Power:	240V ~ 50Hz
No Load Speed:	2,800/min
Drum Speed:	29.5/min
Gross Drum Volume:	120L
Mixed Wet Volume:	91L
Drum Mouth:	ø385mm
IP Rating:	IP44
Weight:	46.5kg



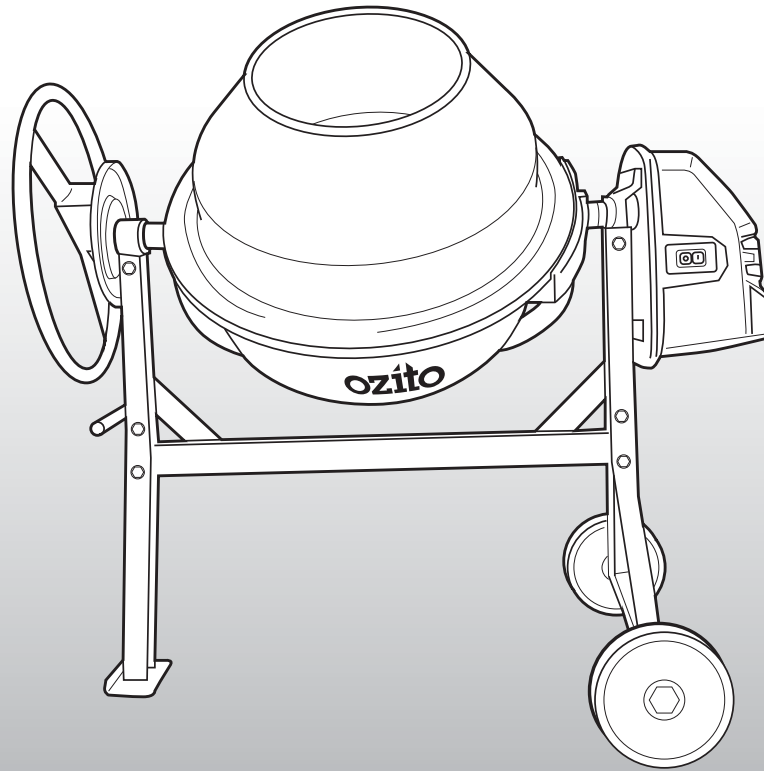



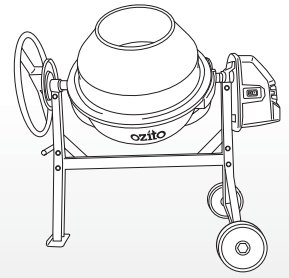

ozito.com.au



STANDARD EQUIPMENT



Cement Mixer

A		x 4
B		x 4
C		x 1 x 2
D		x 2
E		x 6
F		x 2
G		x 1
H		x 4

Assembly Fasteners

3 YEAR REPLACEMENT WARRANTY

CMX-120

WARRANTY

IN ORDER TO MAKE A CLAIM UNDER THIS WARRANTY YOU MUST RETURN THE PRODUCT TO YOUR NEAREST BUNNINGS WAREHOUSE WITH YOUR BUNNINGS REGISTER RECEIPT. PRIOR TO RETURNING YOUR PRODUCT FOR WARRANTY PLEASE TELEPHONE OUR CUSTOMER SERVICE HELPLINE:

Australia 1800 069 486

New Zealand 0508 069 486

TO ENSURE A SPEEDY RESPONSE PLEASE HAVE THE MODEL NUMBER AND DATE OF PURCHASE AVAILABLE. A CUSTOMER SERVICE REPRESENTATIVE WILL TAKE YOUR CALL AND ANSWER ANY QUESTIONS YOU MAY HAVE RELATING TO THE WARRANTY POLICY OR PROCEDURE.

The benefits provided under this warranty are in addition to other rights and remedies which are available to you at law. Our goods come with guarantees that cannot be excluded at law. You are entitled to a replacement or refund for a major failure and for compensation for any other reasonably foreseeable loss or damage. You are also entitled to have the goods repaired or replaced if the goods fail to be of acceptable quality and the failure does not amount to a major failure.

Generally you will be responsible for all costs associated with a claim under this warranty, however, where you have suffered any additional direct loss as a result of a defective product you may be able to claim such expenses by contacting our customer service helpline above.

3 YEAR REPLACEMENT WARRANTY

Your product is guaranteed for a period of **36 months from the original date of purchase**. If a product is defective it will be replaced in accordance with the terms of this warranty. Warranty excludes consumable parts, for example: valve adapters and accessories.

WARNING

The following actions will result in the warranty being void.

- If the tool has been operated on a supply voltage other than that specified on the tool.
- If the tool shows signs of damage or defects caused by or resulting from abuse, accidents or alterations.
- Failure to perform maintenance as set out within the instruction manual.
- If the tool is disassembled or tampered with in any way.
- Professional, industrial or high frequency use.

KNOW YOUR PRODUCT

CEMENT MIXER

1. Tipping Handle
2. Locking Plate
3. Mixing Drum
4. Drive Shaft
5. Drive Shaft Bracket
6. On/Off Switch
7. Motor Housing
8. Transport Wheels
9. Steel Frame
10. Support Leg
11. Transport Handle

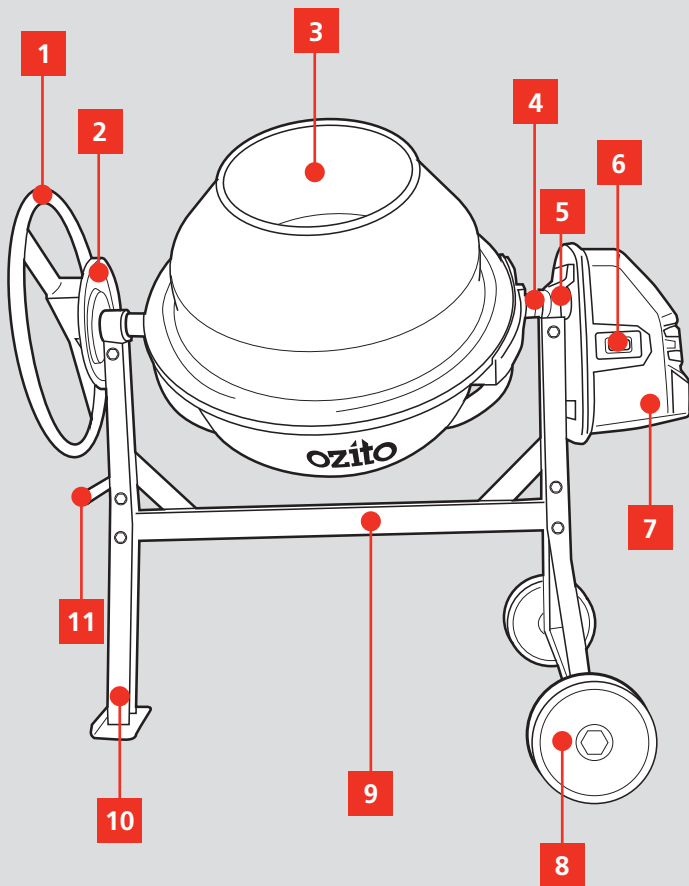

ONLINE MANUAL

Scan this QR Code with your mobile device to take you to the online manual.



SETUP & PREPARATION

1. FRAME ASSEMBLY

WARNING! ENSURE THE TOOL IS SWITCHED OFF AND DISCONNECTED FROM THE POWER SUPPLY BEFORE PERFORMING ANY OF THE FOLLOWING OPERATIONS.

Assembling The Wheel Bracket

Note: It is recommended that 2 people assemble the cement mixer.

Use assembly fasteners bag A.

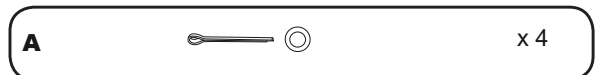

1. On one end of the wheel bracket, insert a split pin into the inner hole. Bend the ends outwards so that the pin does not fall out. Slide a washer onto the shaft on the wheel bracket, followed by a wheel and then another washer. Insert a second split pin into the outer hole and deform the ends as well.

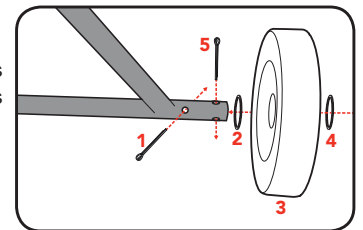

Note: The flat face of the wheel should face outwards.

2. Repeat Step 1 for the other end of the wheel bracket and wheel.

Attaching The Support Leg & Wheel Bracket

Use assembly fasteners bag B.

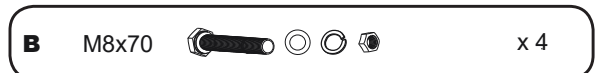

1. Slide the support leg onto the frame. Insert 2 M8x70 bolts through the support leg and frame, then place a washer and spring washer onto each bolt. Secure with the nuts provided.

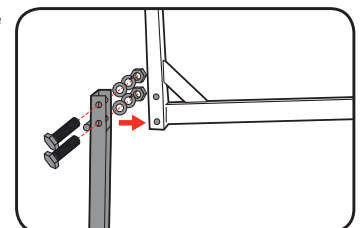

Note: Attach the support leg to the correct end of the frame. Refer to the arrow labels on the frame for proper orientation.

2. Repeat Step 1 with the wheel bracket on the other end of the frame.

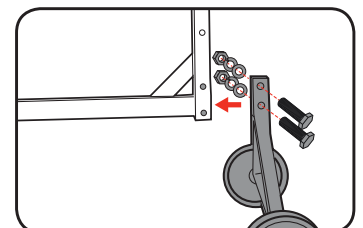

3. Tighten all the bolts and nuts securely.

3 YEAR REPLACEMENT WARRANTY

2. DRUM ASSEMBLY

Attaching The Lower Drum

Use assembly fasteners bag C.



- Slide the drive shaft bracket onto the narrower shaft of the lower drum. Use the ø42mm rubber ring to hold the drive shaft bracket in place.

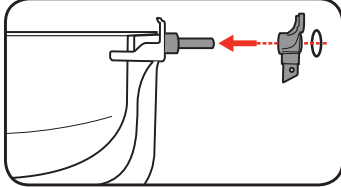

- With the help of a second person, carefully set the lower drum into the frame assembly so that the shaft brackets slot into the channels provided by the frame.

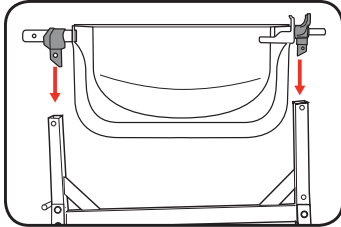

Note: The larger diameter shaft should be above the support leg.

- Place a M8x65 bolt through the hole in the frame, the drive shaft bracket, a washer, spring washer, and then secure it with a nut.

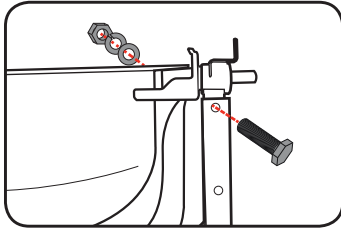

- Repeat Step 3 with the other side of the lower drum assembly.

Fastening The Mixing Blades

Use assembly fasteners bag D.

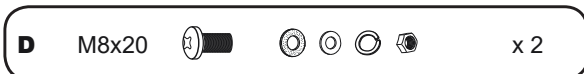

- Slide a M8x20 screw through the base of the drum from the outside. Then place a rubber washer on the screw, followed by the mixing blade, a washer, a spring washer, and then fasten a nut loosely onto the end of the screw.

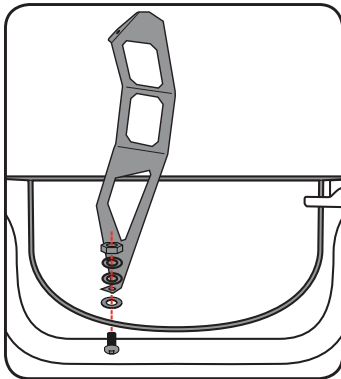

Note: Ensure the mixing blades are in the correct orientation. The mixer blades cannot be secured properly if the blades are upside down. Do not tighten the screw yet as it may make attaching the upper drum more difficult.

- Repeat Step 1 with the other mixing blade.

Assembling The Upper Drum

Use assembly fasteners bag E.

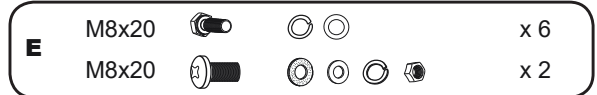

- Place the upper drum over the rim of the lower drum, making sure to align the mounting holes in both halves.

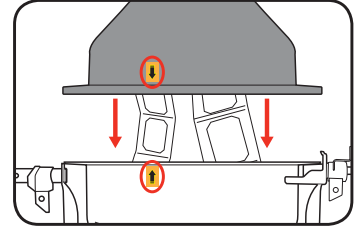

Note: Arrow labels have been placed on the outside of the drum as a reference for aligning the two drum halves. The corresponding mounting holes must be lined up to secure the mixing blades properly.

- Place a spring washer and then washer onto a M8x20 screw, then place this through a threaded hole in the rim of the upper drum.

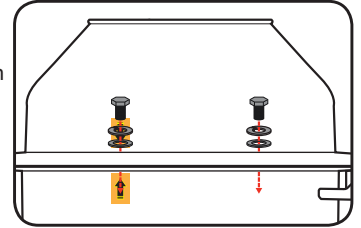

- Repeat Step 3 with the other 5 M8x20 screws around the rim, then tighten all the screws progressively until all 6 are secure.

- Slide a rubber washer between the inside of the upper drum and one of the mixing blades, making sure to align all 3 holes. Then place a M8x20 screw through this assembly from the outside of the drum. Slide a washer, then a spring washer onto the screw and fasten with a nut on the inside.

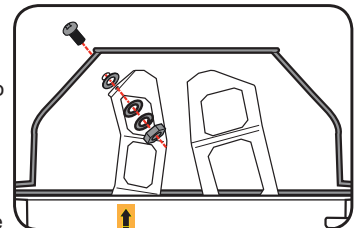

- Repeat Step 4 with the other mixing blade.

- Tighten all of the fixings on the mixing blades and ensure that these are secure.

3. TIPPING HANDLE ASSEMBLY

Attaching The Locking Plate

Use assembly fasteners bag F.

F M8x25    x 2

1. Slide the locking plate over the large diameter shaft at the support leg end of the frame assembly. The flat face of the plate should be facing out.
2. Slide a M8x25 bolt through the locking plate, place a washer and spring washer onto the bolt, and then secure it with a nut. Repeat with the other bolt and hole in the locking plate.

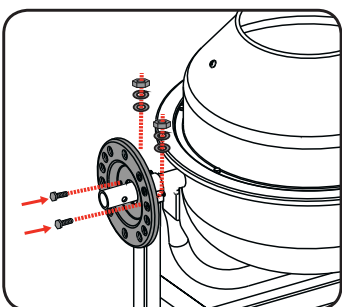

Attaching The Tipping Bar

Use assembly fasteners bag G.

G   x 1
M10x65    x 1

1. Insert the metal disc and then the spring into the sleeve in the middle of the tipping wheel. Holding the spring in place with your finger, slide the tipping wheel onto the shaft in front of the locking plate until the holes in the tipping wheel bracket line up with the holes on the shaft.
3. Slide a washer onto the M10x65 bolt, and place this through the holes in the tipping wheel bracket and shaft. Slide on another washer and then secure this with a nut.

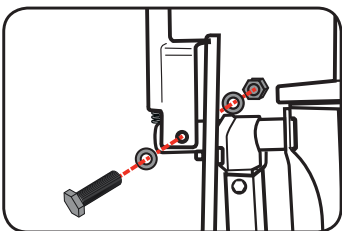
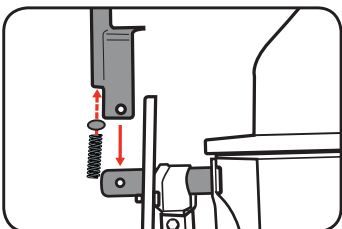

Note: Do not over tighten the bolt and nut against each other as this will prevent the wheel from pivoting about the bolt and allowing you to control the tilt of the mixer drum.

4. MOTOR ASSEMBLY

Connecting The Motor

Use assembly fasteners bag H.

H M8 Nut   x 4

1. Slide the motor case over the pinion shaft, making sure to line the threaded stubs on the case with the holes on the frame.
2. Secure these stubs with the washers and M8 nuts.

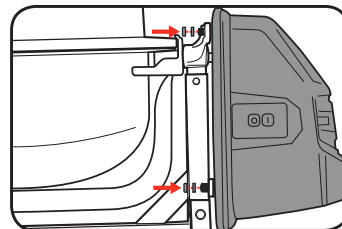
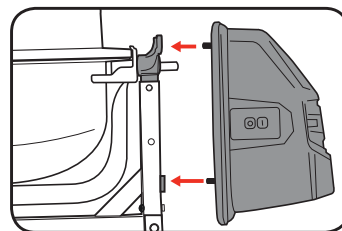

OPERATION

5. CEMENT MIXER SETUP

Unit Placement

The product may only be placed on a flat surface. To provide added stability screw the product to a concrete floor with the proper fixation materials including bolts, screws and washers.

WARNING! DO NOT PLACE ANY MATERIAL UNDER THE PRODUCT TO ADJUST THE HEIGHT OR TO ATTEMPT TO IMPROVE ITS STABILITY! IF THE PRODUCT IS ON AN ANGLE AND/OR WOBBLING, MOVE IT TO A DIFFERENT LOCATION. NEVER OPERATE THE PRODUCT ON SOFT SURFACES SUCH AS A LAWN OR GRAVEL SINCE IT COULD SINK OR TIP OVER DURING OPERATION!

The Support Leg has two mounting holes that can be used to ensure sufficient stability. Use two screws or bolts (not included, recommended size M10) to secure it to a suitable surface.

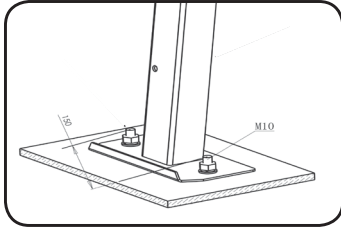

Drip Loop

To avoid the possibility of the appliance plug or power point getting wet, the user should arrange a "drip loop" in the cord connecting the cement mixer to a wall mounted power point.

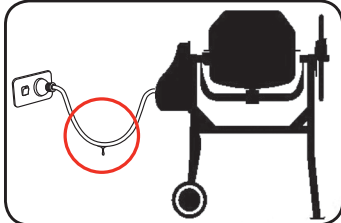

The "drip loop" is the part of the cord that sits below the level of the power point (or the connector if an extension cord is used). It prevents water travelling along the cord and coming in contact with the power point.

6. USAGE

WARNING! TO REDUCE THE RISK OF ELECTRICAL SHOCK, THE USE OF A RESIDUAL CURRENT DEVICE (RATED 30MA OR LESS) IS RECOMMENDED.

Adjusting the Drum Angle

WARNING! MAINTAIN A FIRM GRIP ON THE TIPPING HANDLE WHILE TURNING THE HANDLE.

1. Disengage the locating pins by pulling out on the control handle away from the locking plate to allow the drum to rotate.

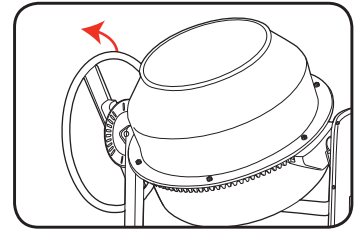

2. Rotate the drum to the desired position by aligning the locating pin with two of the holes in the locking plate.

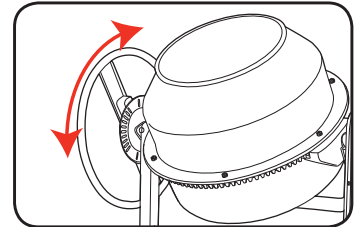

3. Engage the control handle locating pins to secure the position.

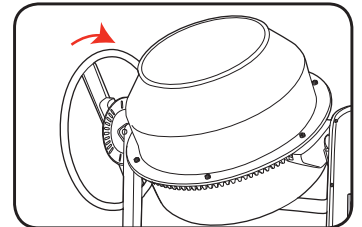

Note: The drum can be set at different positions to cater for mixing mortar and concrete, emptying, or storing.

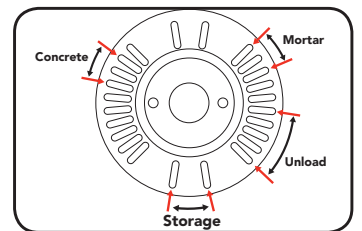

Starting & Stopping The Mixer

1. To start the mixer press the green on "I" button.

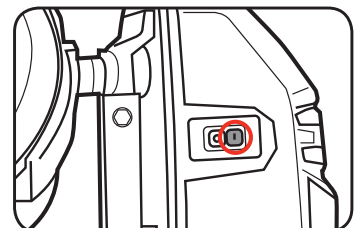

2. To stop the mixer press the red off "O" button.

7. LOADING THE DRUM



WARNING! ALWAYS START THE CEMENT MIXER BEFORE LOADING THE DRUM. LOAD THE DRUM WHILE IT IS ROTATING.



WARNING! ENSURE THE MATERIAL IS NOT LOADED INTO THE MIXER ALL AT ONCE. ADD THE MATERIAL STEADILY OVER THE MIXING BLADES, THIS HELPS PREVENT THE MATERIAL FROM STICKING TO THE BACK OF THE DRUM.

Operating Tips

For best loading results, proceed as follows:

- Add the required amount of stone into the drum.
- Add the required amount of sand into the drum.
- Add the required amount of cement into the drum.
- Pour the required amount of water into the drum.



WARNING!

1. DO NOT LET THE SHOVEL MOUTH OR ANY OTHER DEVICE ENTER THE DRUM MOUTH DURING LOADING.
2. NEVER PLACE HANDS INSIDE THE REVOLVING DRUM OR NEAR ANY ROTATING PARTS.
3. PLACE THE CEMENT MIXER AS CLOSE AS POSSIBLE TO THE WORK SITE. DO NOT MOVE THE CEMENT MIXER WHEN LOADED.
4. RE-TIGHTEN ALL BOLTS ATTACHING MOTOR AND MOTOR HOUSING ASSEMBLY, DRUM ASSEMBLY & FRAME ASSEMBLY AFTER FIRST MIX.

Note: When measuring out cement and ballast (or sharp sand/gravel), use a small bucket to ensure accurate ratios of cement: ballast. Refer to the instructions that come with your cement.

Ensure your chosen quantity of concrete is large enough that the cement mixer will function and small enough that it will fit in the drum, see load sizes in specifications section of manual to calculate quantities.

When the mixture is the right consistency to use, empty the drum. Pour the mixed cement by releasing the tipping handle and rotating the drum to the empty position while the machine is running. Be sure to pour the mix slowly and smoothly to avoid tilting the cement mixer.



WARNING! DO NOT TURN THE MIXER OFF WHILE THERE IS MATERIAL IN THE DRUM UNLESS THE DRUM IS OVERLOADED & EXCESS MATERIAL NEEDS TO BE REMOVED FOR PROPER OPERATION OF THE MIXER. DURING STANDARD OPERATION, THE DRUM SHOULD BE UNLOADED WHILE IT IS STILL ON & ROTATING.

5. TROUBLESHOOTING

Symptom	Possible Cause	Suggested Solution
The cement mixer does not start	Not connected to mains power.	Connect to mains power.
	Power cord or plug is defective.	Contact Ozito Customer Service.
	Other electrical defect in the product.	Contact Ozito Customer Service.
Cement mixer does not reach full power	Extension cord not suitable for operation with this product.	Use a heavy duty extension cord, <25m.
	Power source (eg. a generator) has too low a voltage.	Connect to another power source.
	Mixing volume is too large.	Reduce the amount of material in the drum.
Excessive vibration or noise	Mixer blades are dull/damaged.	Replace with new ones via Ozito Spare Parts.
	Bolts/nuts are loose.	Tighten bolts/nuts.

MAINTENANCE

6. APPLIANCE CARE

 **WARNING!** ENSURE THE TOOL IS SWITCHED OFF & DISCONNECTED FROM THE POWER SUPPLY BEFORE PERFORMING ANY OF THE FOLLOWING MAINTENANCE PROCEDURES.

 **WARNING!** DO NOT POUR OR SPRAY WATER DIRECTLY INTO OR OVER THE MOTOR COVER.

Cleaning





















- Wipe off any external material on the motor cover. Do not use petrol, turpentine, lacquer, paint thinner, dry cleaning fluids or similar products.
- The use of chemical products or solvents may damage the motor cover.
- Thoroughly clean your cement mixer at the end of each days operation. Keep your cement mixer clean. The slightest trace of material left in the drum assembly will harden and attract more material each time the machine is used.
- Dried cement should be scraped out of the drum assembly.
- DO NOT throw bricks into the drum assembly to clean it out.
- DO NOT beat on the drum with a shovel, hammer or other tools to break up accumulation of dried cement mix as the cement mixer may be damaged.
- The drum may be scoured for approximately 2 minutes, using a 1" stone and water mixture. After this, discharge the stone/water mixture and hose down the drum assembly inside and out.
- The IP44 protection clad construction of the mixer enables the DRUM ASSEMBLY ONLY to be hosed down safely. Avoid getting water on the motor and motor housing, DO NOT wet the motor and motor housing.

General Maintenance

- Ball bearings are packed with grease at the factory. No further lubrication of bearings is required.
- During normal use, painted surfaces can lose their coating during the mixing process. Wipe all exposed surfaces regularly with an oily rag to prevent corrosion.
Note: Loss of paint and rust are not covered under warranty.
- Keep air vents clean of dust and dirt.
- Remove dust and dirt from the cement mixer regularly with soft cloth, brush or compressed air. Use a mild detergent and a soft cloth to clean plastic parts.
- If the power cord is damaged, have it replaced by an electrician or a power tool repairer.
- Regularly check that all bolts, screws and nuts are securely fixed as these could work loose during normal operation.
- Do not open the motor cover under any circumstances.

Note: Ozito Industries will not be responsible for any damage or injuries caused by the repair of the tool by an unauthorised person or by mishandling of the tool.

DESCRIPTION OF SYMBOLS

V	Volts	Hz	Hertz
~	Alternating current	W	Watts
/min	Revolutions or reciprocation per minute	No	No load speed
Ø	Diameter	cu ft	Cubic Foot
kPa	Kilo Pascals		Danger of electric shock
Hp	Horse power		Warning
	Double insulated		Regulator compliance mark
	Read Instruction Manual		Wear Safety Boots
	Wear Eye Protection		Wear Safety Gloves
	Do not discharge into drains, soil or water		Do not start the motor if the drum is fully loaded. Do not turn mixer off while full of concrete
	Do not attempt to move the mixer when it is loaded and/or in operation		When operating, do not pass hands through the clearance between frame and support arm or the one between the drum and support arm
	Do not place any part of your body or any tool, like shovel in the drum during operation		Only use or operate the mixer on solid, flat, level ground
	Only use or operate the mixer on solid, flat, level ground		Removing the guard is forbidden
	Do not plug-in mixer with motor cover off		Keep hands out of the way of all moving parts
	Keep bystanders away		Disconnect from power supply when performing maintenance

CARING FOR THE ENVIRONMENT



Power tools that are no longer usable should not be disposed of with household waste but in an environmentally friendly way. Please recycle where facilities exist. Check with your local council authority for recycling advice.



Recycling packaging reduces the need for landfill and raw materials. Reuse of recycled material decreases pollution in the environment. Please recycle packaging where facilities exist. Check with your local council authority for recycling advice.

SPARE PARTS

Spare parts can be ordered from the Special Orders Desk at your local Bunnings Warehouse.

For further information, or any parts not listed here, visit www.ozito.com.au or contact Ozito Customer Service:

Australia 1800 069 486

New Zealand 0508 069 486

E-mail: enquiries@ozito.com.au

ELECTRICAL SAFETY

 **WARNING!** When using mains-powered tools, basic safety precautions, including the following, should always be followed to reduce risk of fire, electric shock, personal injury and material damage.

Read the whole manual carefully and make sure you know how to switch the tool off in an emergency, before operating the tool.

Save all warnings and instructions for future reference.

The electric motor has been designed for 240V only. Always check that the power supply corresponds to the voltage on the rating plate.

Note: The supply of 230V and 240V on Ozito tools are interchangeable for Australia and New Zealand.

This tool is double insulated; therefore no earth wire is required.



Note: Double insulation does not take the place of normal safety precautions when operating this tool. The insulation system is for added protection against injury resulting from a possible electrical insulation failure within the tool.

If the supply cord is damaged, it must be replaced by an electrician or a power tool repairer in order to avoid a hazard.

Using an Extension Lead

Always use an approved extension lead suitable for the power input of this tool. Before use, inspect the extension lead for signs of damage, wear and ageing. Replace the extension lead if damaged or defective. When using an extension lead on a reel, always unwind the lead completely. Use of an extension lead not suitable for the power input of the tool or which is damaged or defective may result in a risk of fire and electric shock.

The power outlet for the compressor is recommended to be protected by a 30amp residual current device

GENERAL POWER TOOL SAFETY WARNINGS

 **WARNING!** Read all safety warnings and all instructions. Failure to follow the warnings and instructions may result in electric shock, fire and/or serious injury. Save all warnings and instructions for future reference. The term "power tool" in the warnings refers to your mains-operated (corded) power tool or battery-operated (cordless) power tool.

1. Work area safety

- a. **Keep work area clean and well lit.** Cluttered or dark areas invite accidents.
 - b. **Do not operate power tools in explosive atmospheres, such as in the presence of flammable liquids, gases or dust.** Power tools create sparks which may ignite the dust or fumes.
 - c. **Keep children and bystanders away while operating a power tool.** Distractions can cause you to lose control.
- ## 2. Electrical safety
- a. **Power tool plugs must match the outlet. Never modify the plug in any way. Do not use any adapter plugs with earthed (grounded) power tools.** Unmodified plugs and matching outlets will reduce risk of electric shock.
 - b. **Avoid body contact with earthed or grounded surfaces, such as pipes, radiators, ranges and refrigerators.** There is an increased risk of electric shock if your body is earthed or grounded.
 - c. **Do not expose power tools to rain or wet conditions.** Water entering a power tool will increase the risk of electric shock.
 - d. **Do not abuse the cord. Never use the cord for carrying, pulling or unplugging the power tool. Keep cord away from heat, oil, sharp edges or moving parts.** Damaged or entangled cords increase the risk of electric shock.
 - e. **When operating a power tool outdoors, use an extension cord suitable for outdoor use.** Use of a cord suitable for outdoor use reduces the risk of electric shock.

3. Personal safety

- a. **Stay alert, watch what you are doing and use common sense when operating a power tool. Do not use a power tool while you are tired or under the influence of drugs, alcohol or medication.** A moment of inattention while operating power tools may result in serious personal injury.
- b. **Use personal protective equipment. Always wear eye protection.** Protective equipment such as dust mask, non-skid safety shoes, hard hat, or hearing protection used for appropriate conditions will reduce personal injuries.
- c. **Prevent unintentional starting. Ensure the switch is in the off-position before connecting to power source and/or battery pack, picking up or carrying the tool. Carrying power tools with your finger on the switch or energising power tools that have the switch on invites accidents.**

- d. **Remove any adjusting key or wrench before turning the power tool on.** A wrench or a key left attached to a rotating part of the power tool may result in personal injury.
 - e. **Do not overreach. Keep proper footing and balance at all times.** This enables better control of the power tool in unexpected situations.
 - f. **Dress properly. Do not wear loose clothing or jewellery. Keep your hair, clothing and gloves away from moving parts.** Loose clothes, jewellery or long hair can be caught in moving parts.
 - g. **If devices are provided for the connection of dust extraction and collection facilities, ensure these are connected and properly used.** Use of dust collection can reduce dust-related hazards.
 - h. **Do not let familiarity gained from frequent use of tools allow you to become complacent and ignore tool safety principles.** A careless action can cause severe injury within a fraction of a second.
- ## 4. Power tool use and care
- a. **Do not force the power tool. Use the correct power tool for your application.** The correct power tool will do the job better and safer at the rate for which it was designed.
 - b. **Do not use the power tool if the switch does not turn it on and off.** Any power tool that cannot be controlled with the switch is dangerous and must be repaired.
 - c. **Disconnect the plug from the power source and/or the battery pack from the power tool before making any adjustments, changing accessories, or storing power tools.** Such preventive safety measures reduce the risk of starting the power tool accidentally.
 - d. **Store idle power tools out of the reach of children and do not allow persons unfamiliar with the power tool or these instructions to operate the power tool.** Power tools are dangerous in the hands of untrained users.
 - e. **Maintain power tools.** Check for misalignment or binding of moving parts, breakage of parts and any other condition that may affect the power tool's operation. If damaged, have the power tool repaired before use. Many accidents are caused by poorly maintained power tools.
 - f. **Keep cutting tools sharp and clean.** Properly maintained cutting tools with sharp cutting edges are less likely to bind and are easier to control.
 - g. **Use the power tool, accessories and tool bits etc. in accordance with these instructions, taking into account the working conditions and the work to be performed.** Use of the power tool for operations different from those intended could result in a hazardous situation.
 - h. **Keep handles and grasping surfaces dry, clean and free from oil and grease.** Slippery handles and grasping surfaces do not allow for safe handling and control of the tool in unexpected situations.
- ## 5. Service
- a. **Have your power tool serviced by a qualified repair person using only identical replacement parts.** This will ensure that the safety of the power tool is maintained.

CEMENT MIXER SAFETY WARNINGS

 The appliance is not to be used by persons (including children) with reduced physical, sensory or mental capabilities, or lack of experience and knowledge, unless they have been given supervision or instruction.

Young children should be supervised to ensure that they do not play with the appliance.

WARNING! For your own safety, do not try to use your cement mixer or plug it in until it is completely assembled and installed according to the instructions and until you have read and understood the following:

- Avoid dangerous conditions. Do not use the mixer in wet or damp areas or expose it to rain. Do not use it in areas where fumes from paint, solvents or flammable liquids pose a potential hazard.
- Inspect your cement mixer. Check your cement mixer before turning it on. Keep guards in place and in working order. Form a habit of checking to see that keys and adjusting wrenches are removed from the cement mixer area before turning on. Replace damaged, missing or failed parts before using it.

- Wear protective gear. Foreign objects may be thrown from the cement mixer while in operation. This can cause facial injuries. Always wear safety goggles and/or face shields.
- Do not touch the rotating drum during operation. Keep limbs, hair and objects clear of moving parts.
- Never leave cement mixer running unattended. Don't leave cement mixer until it has come to a complete stop.
- Disconnect power. Unplug when not in use, before making adjustments, changing parts, cleaning, or working on the mixer.
- Maintain your cement mixer with care. Clean the cement mixer immediately after use. Keep the cement mixer clean for best and safest performance.
- Moving the cement mixer. Do not tow the cement mixer by using a vehicle. Use an approved trailer to move the cement mixer if it is to be transported.
- Drugs, alcohol and medication. Do not operate the mixer while under the influence of drugs, alcohol, or any medication that could affect your ability to use it properly.