

# ozito

## ROTARY HAMMER DRILL KIT

**1500W**

### INSTRUCTION MANUAL

### SPECIFICATIONS

Motor:	1500W
Impact Power:	5 Joule
Impact Rate:	3,000 bpm
No Load Speed:	750/min
Accessory Fitment:	SDS+
Drilling Capacities:	Timber 40mm
	Steel 13mm
	Masonry 36mm

[ozito.com.au](http://ozito.com.au)

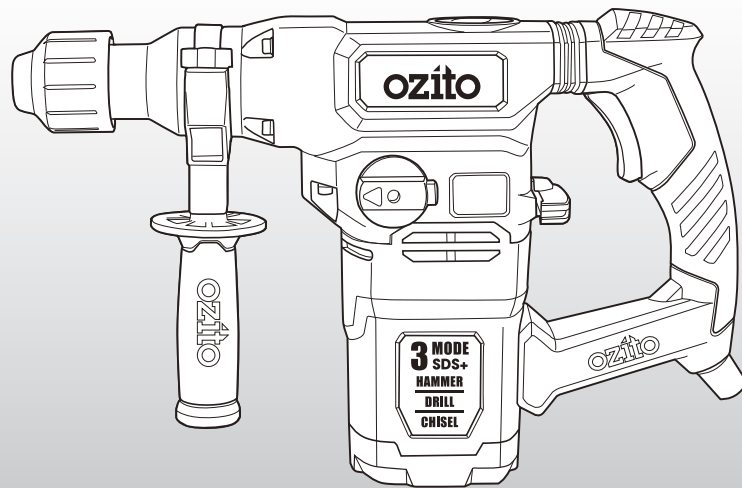

### WHAT'S IN THE BOX

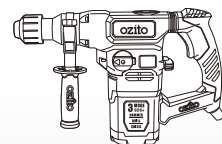

#### Rotary Hammer Drill

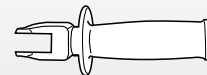

#### Side Handle

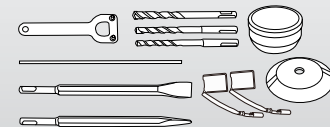

#### Accessories

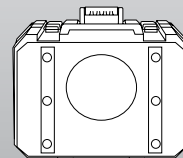

#### Kit Box

**1** YEAR REPLACEMENT WARRANTY

RHD-6100

# KNOW YOUR PRODUCT

## ROTARY HAMMER DRILL

- |                            |                          |
|----------------------------|--------------------------|
| 1 SDS+ Accessory Holder    | 6 Side Mode Selector     |
| 2 Accessory Locking Sleeve | 7 Grease Cap             |
| 3 Magnesium Gear Case      | 8 Rear Mode Selector     |
| 4 Side Handle              | 9 On/Off Switch          |
| 5 Depth Rod Locking Knob   | 10 Soft Grip Rear Handle |

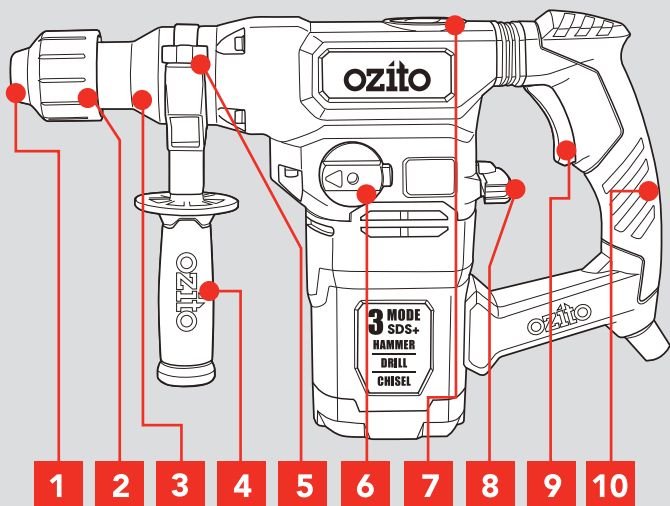

## ACCESSORIES

- |  |                   |
|--|-------------------|
| 11 Depth Rod                           | 15 Dust Cover     |
| 12 3 x SDS+ 150mm Drill Bits           | 16 Tub of Grease  |
| 13 1 x SDS+ Flat Chisel<br>14 x 250mm  | 17 Pin Spanner    |
| 14 1 x SDS+ Point Chisel<br>14 x 250mm | 18 Carbon Brushes |

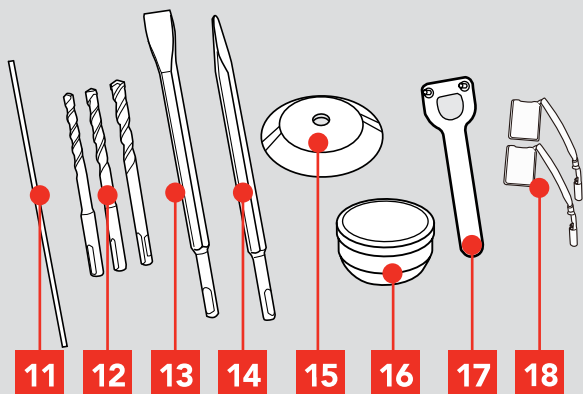

## ONLINE MANUAL

Scan this QR Code with your mobile device to take you to the online manual.



# SETUP & PREPARATION

## 1. USING THE DEPTH ROD

Ensure the tool is disconnected from the power supply before performing any of the following operations.

The depth rod allows you to drill to a predetermined depth.

1. Loosen the depth rod securing nut then insert depth rod.

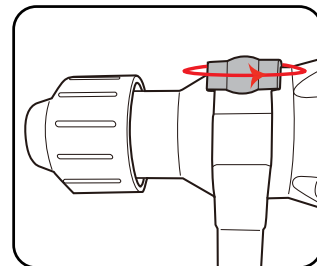

2. Adjust the depth rod so the drill bit extends beyond the end of the depth rod to the required drilling depth.

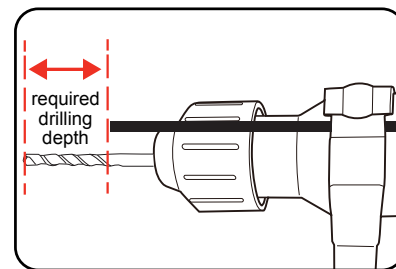

3. Tighten the depth rod securing nut to lock the depth rod into place.

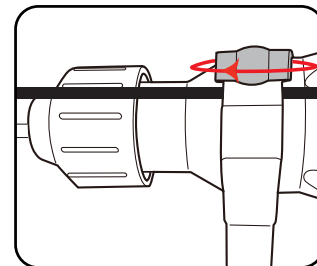

4. Drill the hole until the end of the depth rod touches the workpiece.

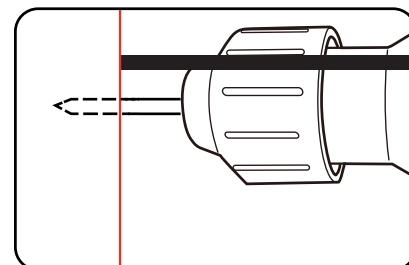

# 1 YEAR REPLACEMENT WARRANTY

## 2. SDS+ ACCESSORIES

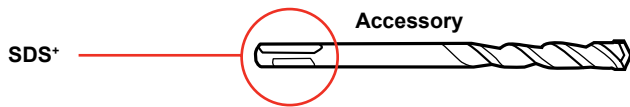

1. Prior to insertion into chuck, ensure the SDS+ accessory is clear of dust and debris.

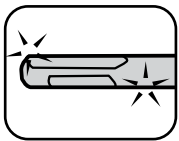

2. Prior to insertion into drill add supplied lubricant to the SDS+ accessory.

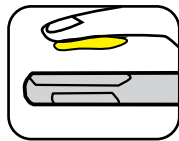

3. Pull locking sleeve back and hold.

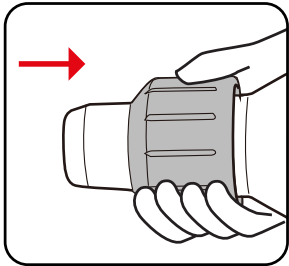

4. Insert SDS+ Accessory.

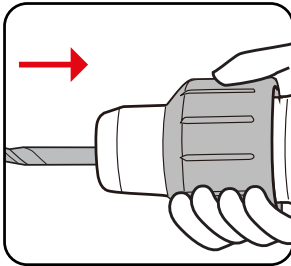

5. Rotate and continue to insert as far as possible.

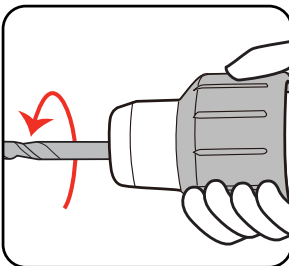

6. Release locking sleeve.

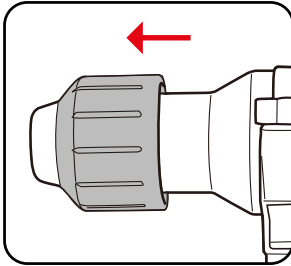

7. Checked SDS+ accessory is locked. Try to pull it out. Note: It should have approx 10 – 20mm movement. This is normal.

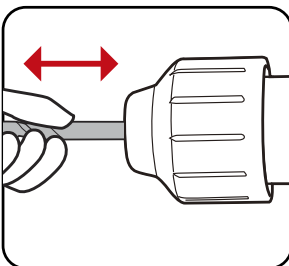

8. To remove the SDS+ accessory pull back the locking sleeve and pull accessory out.

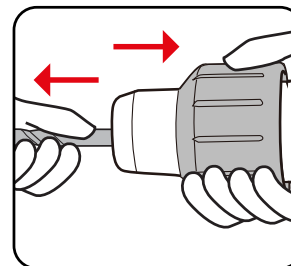

## 3. FITTING AND USING THE DUST COVER

The cover catches dust and debris - while using the drill upright or overhead - to avoid dust entering the air vents.

1. Slide dust cover over accessory.

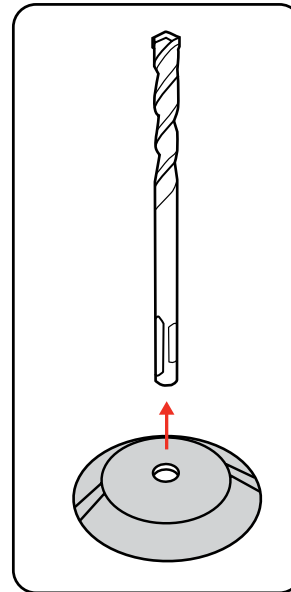

2. Add lubrication grease.

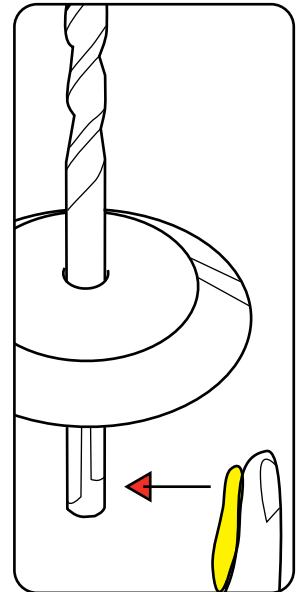

3. Insert drill bit in locking sleeve.

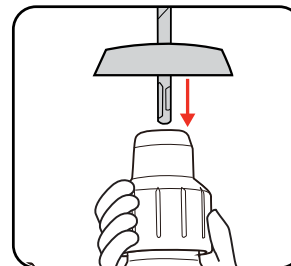

4. Press dust cover to the end of locking sleeve.

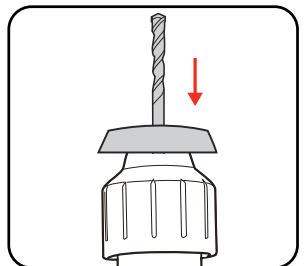

# OPERATION

## 4. OPERATING THE HAMMER DRILL

### 1. Choose an operation mode:



Side mode selector

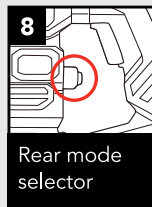

Rear mode selector

### Hammer Drill

Rotate the side mode selector to the hammer and drill icon, and rotate the rear mode selector to the drill and hammer icon. This setting is recommended for use when drilling holes in concrete and other masonry products. The hammer action will be in operation while simultaneously the drill bit rotates.



### Chiselling

Rotate the side mode selector to the hammer icon, and rotate the rear mode selector to the drill and hammer icon. This setting is recommended for use when you desire a hammer action without the accessory rotating which is ideal for "chiseling or chipping" away at masonry products, pick or chisel accessory bits should be used.



### Drilling

Rotate the side mode selector to the hammer and drill icon, and rotate the rear mode selector to the drill icon. This setting is recommended for use when you desire the accessory to rotate without hammer action. Ideal for drilling into timber or steel when correct accessories for such materials are used.



2. Ensure your workpiece is securely clamped where possible.
3. Connect the tool to the mains power supply.

4. To start drilling squeeze the On/Off switch.

5. To stop drilling release the On/Off switch.

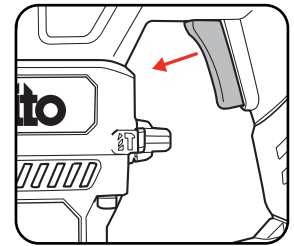
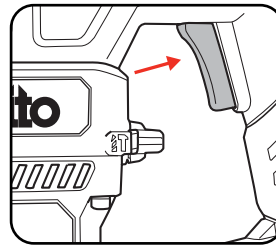

**NOTE:** PRIOR TO CHANGING MODES, THE ON/OFF SWITCH SHOULD BE RELEASED AND THE DRILL SHOULD HAVE COME TO A COMPLETE STOP.

# MAINTENANCE

- Keep the ventilation vents of the drill clean at all times.
- After each use, blow air through the drill housing to ensure it is free from all dust particles which may build up. Build up of dust particles may cause the drill to overheat and fail.
- If the enclosure of the drill requires cleaning, do not use solvents but a moist soft cloth only. Never let any liquid get inside the drill; never immerse any part of the drill into a liquid.

## Gear Box Grease Replenishment

The grease in the gearbox will require replenishment after approximately 50 hours accumulative use. After this time, add approximately 50 grams (approx 2 – 3 teaspoons) of the grease (supplied), into the gearbox. First remove the grease cap from the drill by using the pin spanner. Once removed, add the grease through this hole. Ensure the grease cap is secured back into position prior to operation. Further grease (normal ball bearing grease) can be purchased through your local Bunnings Warehouse.

## Carbon Brushes

When the carbon brushes wear out, the drill will spark and/or stop. Discontinue use as soon as this happens. They should be replaced prior to recommencing use of the drill. Carbon brushes are a wearing component of the drill therefore not covered under warranty. Continuing to use the drill when carbon brushes need to be replaced may cause permanent damage to the drill. Carbon brushes will wear out after many uses but when the carbon brushes need to be replaced, take the drill to an electrician or a power tool repairer for a quick and low cost replacement. Always replace both carbon brushes at the same time.



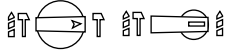

*Note: Ozito Industries will not be responsible for any damage or injuries caused by the repair of the drill by an unauthorised person or by mishandling of the drill.*

# TROUBLE SHOOTING

Problem	Cause	Remedy
<b>Rotary Hammer Drill is not working</b>	No power supplied	make sure all plugs are connected and power outlet is in working order
	Mode Selectors in wrong position. Chisel Function will not engage if mode selectors are as shown below	Please refer to 'Operating The Hammer Drill' section in the manual.
		
<b>Hammer Function Not Engaging</b>	Excess grease has been packed	Insert SDS+ accessory and then set both the modes to hammer function. Turn the drill on, firmly tap the accessory bit up and down onto a scrap piece of material to activate.
	Motor brushes binding in brush holders.	Clean brush holders. Remove carbon dust by using compressed air to blow out brush dust
<b>Excessive sparking visible through air vents</b>	carbon brushes have worn out	replace carbon brushes as per maintenance section.

# DESCRIPTION OF SYMBOLS

V	Volts	Hz	Hertz
~	Alternating current	W	Watts
/min	Revolutions or reciprocation per minute	n <sub>o</sub>	No load speed
/bpm	Impact rate	∅	Diameter
	Double insulated		Regulator compliance mark
	Warning		

# SPARE PARTS

Brush Holder (pair)	SPRHD6100-84
Carbon Brush (pair)	SPRHD6100-86
Switch	SPRHD6100-93
Side Handle	SPRHD6100-114A

**Spare parts can be ordered from the Special Orders Desk at your local Bunnings Warehouse.**

**For further information, or any parts not listed here, visit [www.ozito.com.au](http://www.ozito.com.au) or contact Ozito Customer Service:**

**Australia 1800 069 486**

**New Zealand 0508 069 486**

**E-mail: [enquires@ozito.com.au](mailto:enquires@ozito.com.au)**

# CARING FOR THE ENVIRONMENT



Power tools that are no longer usable should not be disposed of with household waste but in an environmentally friendly way. Please recycle where facilities exist. Check with your local council authority for recycling advice.



Recycling packaging reduces the need for landfill and raw materials. Reuse of recycled material decreases pollution in the environment. Please recycle packaging where facilities exist. Check with your local council authority for recycling advice.

# SPARE PARTS

Tool: 1500W Rotary Hammer Drill  
Model No. RHD-6100

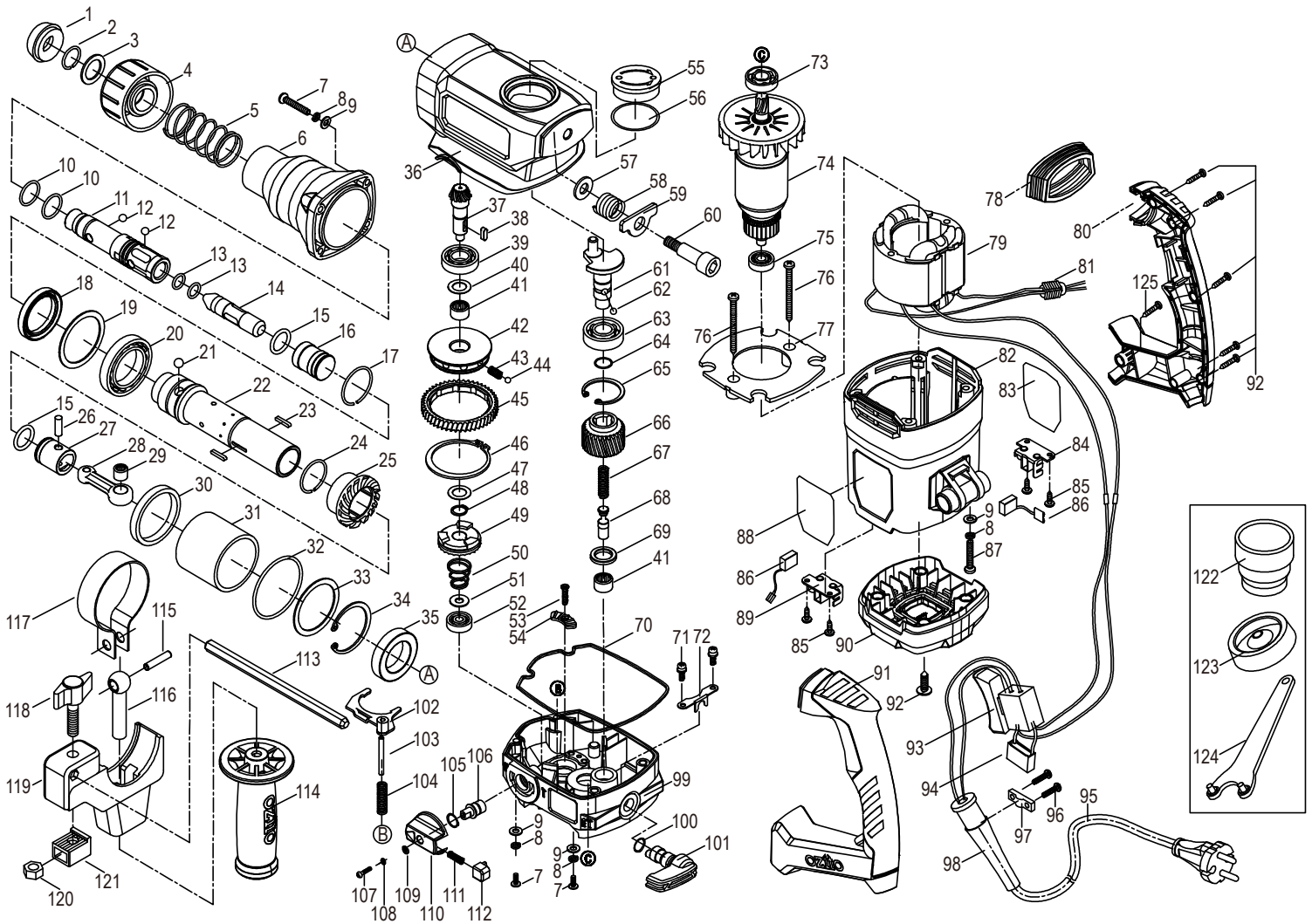

The following is a list of spare parts carried by Ozito. Please contact Customer Service for any parts not listed.

Item No.	Description	Part No.	Item No.	Description	Part No.
84	Brush Holder (pair)	SPRHD6100-84			
86	Carbon Brush (pair)	SPRHD6100-86			
93	Switch	SPRHD6100-93			
114	Side Handle	SPRHD6100-114A			

## How To Order

Available spare parts can be ordered through the Special Orders Desk at any Bunnings Warehouse. If you have any further questions, please contact Ozito Customer Service on:

Australia: 1800 069 486

New Zealand: 0508 069 486

enquiries@ozito.com.au

# ELECTRICAL SAFETY

 **WARNING!** When using mains-powered tools, basic safety precautions, including the following, should always be followed to reduce risk of fire, electric shock, personal injury and material damage.

Read the whole manual carefully and make sure you know how to switch the tool off in an emergency, before operating the tool.

Save these instructions and other documents supplied with this tool for future reference.

The electric motor has been designed for 230V and 240V only. Always check that the power supply corresponds to the voltage on the rating plate.

Note: The supply of 230V and 240V on Ozito tools are interchangeable for Australia and New Zealand.



This tool is double insulated in accordance with AS/NZS 60745-1; therefore no earth wire is required.

If the supply cord is damaged, it must be replaced by an electrician or a power tool repairer in order to avoid a hazard.

**Note:** Double insulation does not take the place of normal safety precautions when operating this tool. The insulation system is for added protection against injury resulting from a possible electrical insulation failure within the tool.

## Using an Extension Lead

Always use an approved extension lead suitable for the power input of this tool. Before use, inspect the extension lead for signs of damage, wear and ageing. Replace the extension lead if damaged or defective. When using an extension lead on a reel, always unwind the lead completely. Use of an extension lead not suitable for the power input of the tool or which is damaged or defective may result in a risk of fire and electric shock.

# GENERAL POWER TOOL SAFETY WARNINGS

 **WARNING!** Read all safety warnings and all instructions. Failure to follow the warnings and instructions may result in electric shock, fire and/or serious injury. Save all warnings and instructions for future reference. The term "power tool" in the warnings refers to your mains-operated (corded) power tool or battery-operated (cordless) power tool.

## 1. Work area safety

- Keep work area clean and well lit.** Cluttered or dark areas invite accidents.
- Do not operate power tools in explosive atmospheres, such as in the presence of flammable liquids, gases or dust.** Power tools create sparks which may ignite the dust or fumes.
- Keep children and bystanders away while operating a power tool.** Distractions can cause you to lose control.

## 2. Electrical safety

- Power tool plugs must match the outlet. Never modify the plug in any way. Do not use any adapter plugs with earthed (grounded) power tools.** Unmodified plugs and matching outlets will reduce risk of electric shock.
- Avoid body contact with earthed or grounded surfaces, such as pipes, radiators, ranges and refrigerators.** There is an increased risk of electric shock if your body is earthed or grounded.
- Do not expose power tools to rain or wet conditions.** Water entering a power tool will increase the risk of electric shock.
- Do not abuse the cord. Never use the cord for carrying, pulling or unplugging the power tool. Keep cord away from heat, oil, sharp edges or moving parts.** Damaged or entangled cords increase the risk of electric shock.
- When operating a power tool outdoors, use an extension cord suitable for outdoor use.** Use of a cord suitable for outdoor use reduces the risk of electric shock.
- If operating a power tool in a damp location is unavoidable, use a residual current device (RCD) protected supply.** Use of an RCD reduces the risk of electric shock.

## 3. Personal safety

- Stay alert, watch what you are doing and use common sense when operating a power tool. Do not use a power tool while you are tired or under the influence of drugs, alcohol or medication.** A moment of inattention while operating power tools may result in serious personal injury.
- Use personal protective equipment. Always wear eye protection.** Protective equipment such as dust mask, non-skid safety shoes, hard hat, or hearing protection used for appropriate conditions will reduce personal injuries.
- Prevent unintentional starting. Ensure the switch is in the off-position before connecting to power source and/or battery pack, picking up or carrying the tool.** Carrying power

tools with your finger on the switch or energising power tools that have the switch on invites accidents.

- Remove any adjusting key or wrench before turning the power tool on.** A wrench or a key left attached to a rotating part of the power tool may result in personal injury.
  - Do not overreach. Keep proper footing and balance at all times.** This enables better control of the power tool in unexpected situations.
  - Dress properly. Do not wear loose clothing or jewellery. Keep your hair, clothing and gloves away from moving parts.** Loose clothes, jewellery or long hair can be caught in moving parts.
  - If devices are provided for the connection of dust extraction and collection facilities, ensure these are connected and properly used.** Use of dust collection can reduce dust-related hazards.
- ## 4. Power tool use and care
- Do not force the power tool. Use the correct power tool for your application.** The correct power tool will do the job better and safer at the rate for which it was designed.
  - Do not use the power tool if the switch does not turn it on and off.** Any power tool that cannot be controlled with the switch is dangerous and must be repaired.
  - Disconnect the plug from the power source and/or the battery pack from the power tool before making any adjustments, changing accessories, or storing power tools.** Such preventive safety measures reduce the risk of starting the power tool accidentally.
  - Store idle power tools out of the reach of children and do not allow persons unfamiliar with the power tool or these instructions to operate the power tool.** Power tools are dangerous in the hands of untrained users.
  - Maintain power tools. Check for misalignment or binding of moving parts, breakage of parts and any other condition that may affect the power tool's operation. If damaged, have the power tool repaired before use.** Many accidents are caused by poorly maintained power tools.
  - Keep cutting tools sharp and clean.** Properly maintained cutting tools with sharp cutting edges are less likely to bind and are easier to control.
  - Use the power tool, accessories and tool bits etc. in accordance with these instructions, taking into account the working conditions and the work to be performed.** Use of the power tool for operations different from those intended could result in a hazardous situation.
- ## 5. Service
- Have your power tool serviced by a qualified repair person using only identical replacement parts.** This will ensure that the safety of the power tool is maintained.
  - If the supply cord is damaged, it must be replaced by the manufacturer, its service agent or similarly qualified persons in order to avoid a hazard.**

# ROTARY HAMMER DRILL SAFETY WARNINGS

- **Wear ear protectors.** Exposure to noise can cause hearing loss.
- **Use auxiliary handle(s), if supplied with the tool.** Loss of control can cause personal injury.
- **Hold power tool by insulated gripping surfaces, when performing an operation where the cutting accessory may contact hidden wiring or its own cord.** Cutting accessory contacting a "live" wire may make exposed metal parts of the power tool "live" and could give the operator an electric shock.

 **WARNING!** This appliance is not intended for use by persons (including children) with reduced physical, sensory or mental capabilities, or lack of experience and knowledge, unless they have been given supervision or instruction concerning use of the appliance by a person responsible for their safety.

**Recommendations for the use of a residual current device** with a rated residual current of 30mA or less.

## Using an Extension Lead

- Always use an approved extension lead suitable for the power input of this tool. Before use, inspect the extension lead for signs of damage, wear and ageing. Replace the extension lead if damaged or defective.
- When using an extension lead on a reel, always unwind the lead completely. Use of an extension lead not suitable for the power input of the tool or which is damaged or defective may result in a risk of fire and electric shock.
- It is recommended that the extension lead is a maximum of 25m in length. Do Not use multiple extension leads.
- Before drilling into walls, ceilings etc, ensure there are no concealed power cables or pipes in the cavity.
- Always use the side handle, this gives you greater control if the accessory should become jammed.
- Keep the cord clear of the accessory being used, do not wrap the cord around your arm or wrist.
- Hold the tool by the insulated gripping surfaces when performing an operation where the accessory may contact hidden wiring or its own cord.

- Use thick cushioned gloves and limit the exposure time by taking frequent breaks.
- Vibration caused by the hammer action may be harmful to your hands and arms.
- When removing an accessory from the tool avoid contact with skin and use proper protective gloves when grasping the bit or accessory. Accessories may be hot after prolonged use.

 **WARNING!** Some dust created by power sanding, sawing, grinding, drilling and other construction activities contain chemicals known to cause cancer, birth defects or other reproductive harm.

Some examples of these chemicals are:

- Lead from lead-based paints;
- Crystalline silica from bricks, cement and other masonry products, and;
- Arsenic and chromium from chemically-treated timber.

The risk from such exposures vary depending on how often you do this type of work. To reduce your exposure to these chemicals; work in a well ventilated area, and work with approved safety equipment, such as those dust masks that are specifically designed to filter out microscopic particles.

Always wear eye protection and a dust mask for dusty applications and when drilling/chiselling overhead. Sanding particles can be absorbed by your eyes and inhaled easily and may cause health complications.

## Special requirements:

- Wear ear protectors. Exposure to noise can cause hearing loss.
- Use auxiliary handles supplied with the tool. Loss of control can cause personal injury.

# WARRANTY

IN ORDER TO MAKE A CLAIM UNDER THIS WARRANTY YOU MUST RETURN THE PRODUCT TO YOUR NEAREST BUNNINGS WAREHOUSE WITH YOUR BUNNINGS REGISTER RECEIPT. PRIOR TO RETURNING YOUR PRODUCT FOR WARRANTY PLEASE TELEPHONE OUR CUSTOMER SERVICE HELPLINE:

**Australia 1800 069 486**

**New Zealand 0508 069 486**

TO ENSURE A SPEEDY RESPONSE PLEASE HAVE THE MODEL NUMBER AND DATE OF PURCHASE AVAILABLE. A CUSTOMER SERVICE REPRESENTATIVE WILL TAKE YOUR CALL AND ANSWER ANY QUESTIONS YOU MAY HAVE RELATING TO THE WARRANTY POLICY OR PROCEDURE.

The benefits provided under this warranty are in addition to other rights and remedies which are available to you at law.

Our goods come with guarantees that cannot be excluded at law. You are entitled to a replacement or refund for a major failure and for compensation for any other reasonably foreseeable loss or damage. You are also entitled to have the goods repaired or replaced if the goods fail to be of acceptable quality and the failure does not amount to a major failure.

Generally you will be responsible for all costs associated with a claim under this warranty, however, where you have suffered any additional direct loss as a result of a defective product you may be able to claim such expenses by contacting our customer service helpline above.

## 1 YEAR REPLACEMENT WARRANTY

Your product is guaranteed for a period of **12 months from the original date of purchase** and is intended for DIY (Do It Yourself) use only. If a product is defective it will be replaced in accordance with the terms of this warranty. Warranty excludes consumable parts, for example: carbon brushes, included accessories etc.

## WARNING

**The following actions will result in the warranty being void.**

- If the tool has been operated on a supply voltage other than that specified on the tool.
- If the tool shows signs of damage or defects caused by or resulting from abuse, accidents or alterations.
- Failure to perform maintenance as set out within the instruction manual.
- If the tool is disassembled or tampered with in any way.
- Professional, industrial or high frequency use.