

# UNIVERSAL CLOTHES DRYER WALL MOUNTING KIT

## Step by Step Installation Instructions

### 1 Fit Dryer Brackets

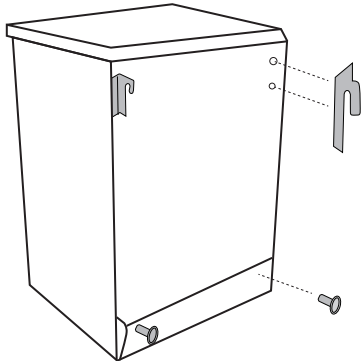

When locating the mounting brackets onto the dryer back panel, you may notice only one screw hole. If this is the case, you will need to take the other self-tapping screws to push and pierce the dryer back panel. (this will locate the hole beneath the back panel). Continue to turn the self-tapping screws until tightens. Once done, in the same manner fit the spacers to the back of the dryer.

### 3 Select Mounting Position

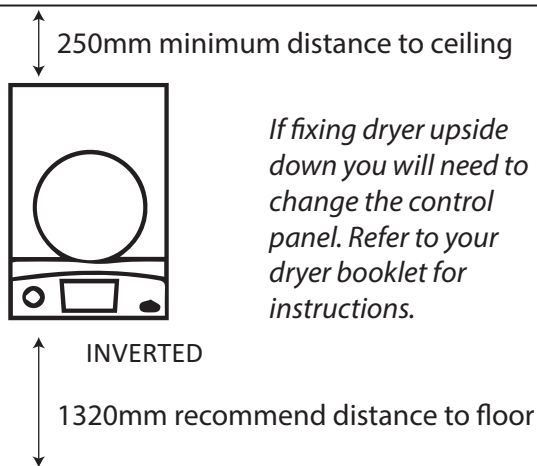

*If fixing dryer upside down you will need to change the control panel. Refer to your dryer booklet for instructions.*

Determine position on the wall using your dryer measurements. If mounting above a top loading machine remember to leave sufficient space for the lid to open. 250mm minimum clearance distance from the ceiling.

### 5 Fitting Dryer to the Wall Brackets.

You will need help from another person. Together lift the dryer into place making sure that the dryer brackets fit correctly into the wall brackets as per diagram.

Bottom spacer at bottom of dryer

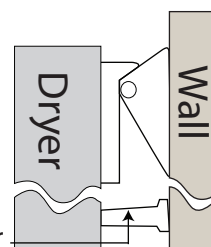

### 2 Dryer Measurements

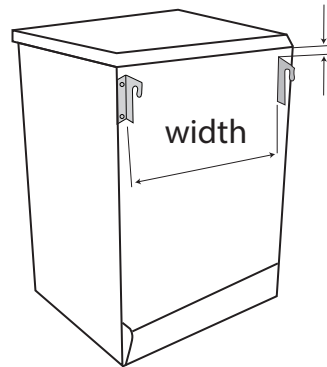

Note the measurements from the top of the dryer to the top of the dryer bracket and the distance between the dryer brackets etc.

### 4 Fix Wall Brackets

Fix the wall brackets to the wall using the large wood screws provided. Make sure the brackets are firmly fastened to the wall. If you cannot screw directly into a stud you will need to fit a 75x20mm timber batten as shown above and attach the brackets to the batten.

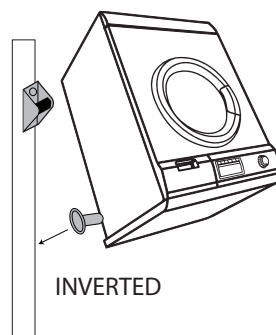
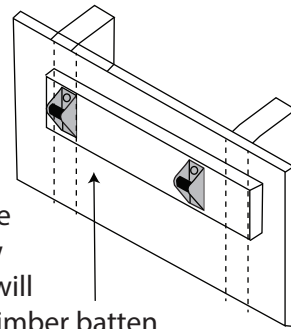

INVERTED

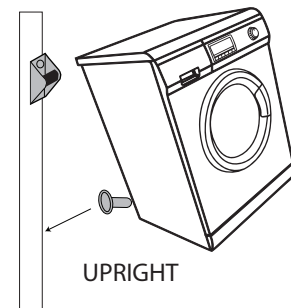

UPRIGHT

You will need to pack at the bottom spacers by the same thickness as the batten to keep the dryer upright and level.

**Suitable for various brands**

### Important

*Check with your dryer's manufacturer to ensure your model is suitable for being inverted and/or wall fixing.*

### What you will need

Tape measure  
Phillips head screwdriver  
8mm nut drive or socket  
3mm drill bit  
Electric drill  
*If fitting to concrete you will also need:*  
6mm concrete drill bit  
4xM6 x 50 expanding bolts

### Kit includes

2 x wall brackets  
1 x RH dryer bracket  
1 x LH dryer bracket  
4 x Tek wood screws  
4 x PK screws  
2 x Spacers