



18V LITHIUM ION

HAMMER DRILL

INSTRUCTION MANUAL

SPECIFICATIONS

Input:	18V
Chuck Size:	Ø2 - 13mm Keyless
Chuck Material:	Metal
No Load Speed:	0-400 / 0-1,500/min
Impact Rate:	0-6,400 / 0-24,000bpm
Torque Setting:	21
Max. Torque:	40Nm
Drilling Capacities:	32mm (Timber) 10mm (Masonry) 13mm (Metal)
Weight:	1.12kg

ozito.com.au

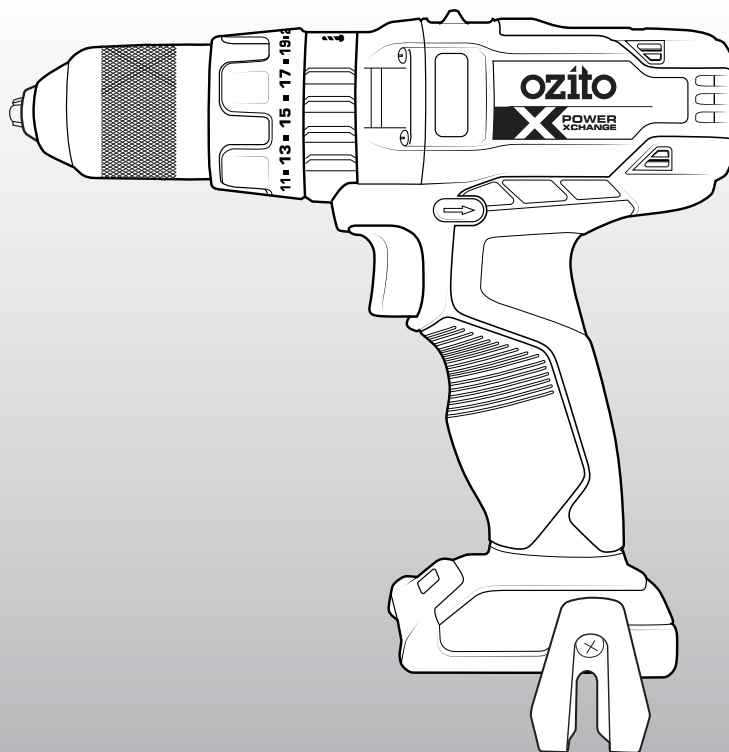

STANDARD EQUIPMENT

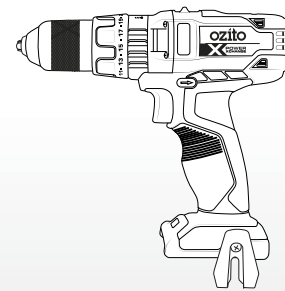

Cordless 13mm Hammer Drill

PXHDS-180

WARRANTY

IN ORDER TO MAKE A CLAIM UNDER THIS WARRANTY YOU MUST RETURN THE PRODUCT TO YOUR NEAREST BUNNINGS WAREHOUSE WITH YOUR BUNNINGS REGISTER RECEIPT. PRIOR TO RETURNING YOUR PRODUCT FOR WARRANTY PLEASE TELEPHONE OUR CUSTOMER SERVICE HELPLINE:

Australia 1800 069 486

New Zealand 0508 069 486

TO ENSURE A SPEEDY RESPONSE PLEASE HAVE THE MODEL NUMBER AND DATE OF PURCHASE AVAILABLE. A CUSTOMER SERVICE REPRESENTATIVE WILL TAKE YOUR CALL AND ANSWER ANY QUESTIONS YOU MAY HAVE RELATING TO THE WARRANTY POLICY OR PROCEDURE.

WARNING

The following actions will result in the warranty being void.

- If the tool has been operated on a supply voltage other than that specified on the tool.
- If the tool shows signs of damage or defects caused by or resulting from abuse, accidents or alterations.
- Failure to perform maintenance as set out within the instruction manual.
- If the tool is disassembled or tampered with in any way.

The benefits provided under this warranty are in addition to other rights and remedies which are available to you at law.

Our goods come with guarantees that cannot be excluded at law. You are entitled to a replacement or refund for a major failure and for compensation for any other reasonably foreseeable loss or damage. You are also entitled to have the goods repaired or replaced if the goods fail to be of acceptable quality and the failure does not amount to a major failure.

Generally you will be responsible for all costs associated with a claim under this warranty, however, where you have suffered any additional direct loss as a result of a defective product you may be able to claim such expenses by contacting our customer service helpline above.

5 YEAR REPLACEMENT WARRANTY

Your Product is guaranteed for a period of 60 months from the original date of purchase and is intended for DIY (Do It Yourself) use only. If a product is defective it will be replaced in accordance with the terms of this warranty. **Lithium Ion batteries and chargers are covered by a 36 month warranty** and are excluded from the warranty extension. Warranty excludes consumable parts.

KNOW YOUR PRODUCT

HAMMER DRILL

- | | |
|----------------------------|--------------------------|
| 1 Keyless Chuck | 6 Battery Seating |
| 2 Torque Adjustment Collar | 7 Belt Clip |
| 3 Function Collar | 8 Forward/ Reverse Lever |
| 4 Variable Speed Trigger | 9 Gear Selector |
| 5 LED Light | |

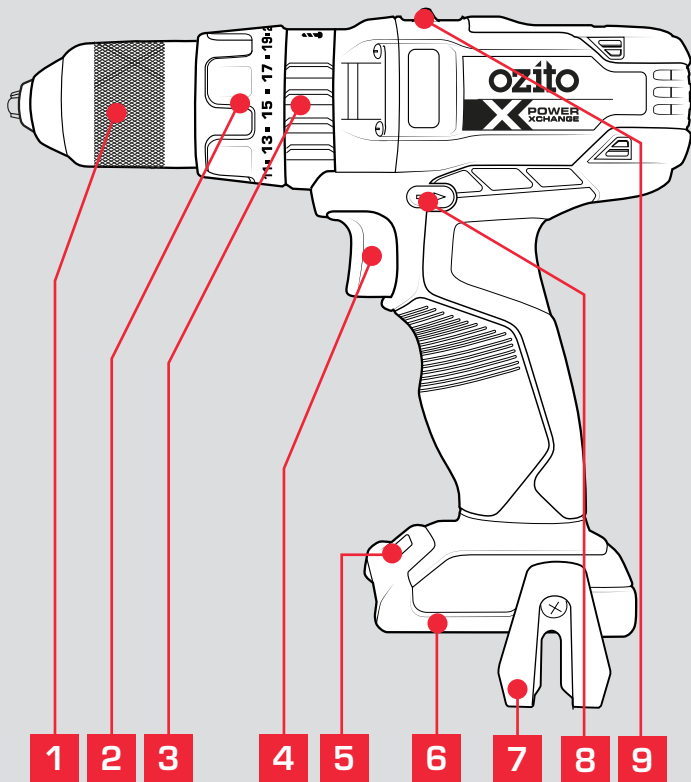

1 2 3 4 5 6 7 8 9

BATTERY & CHARGER

This tool is compatible with all battery and chargers from the Ozito Power X Change Range.

ONLINE MANUAL

Scan this QR Code with your mobile device to take you to the online manual.



SETUP & PREPARATION

1. BATTERY INSTALLATION

Installing the Battery Pack

- 1 Slide the battery into the drill base until it clicks into place.

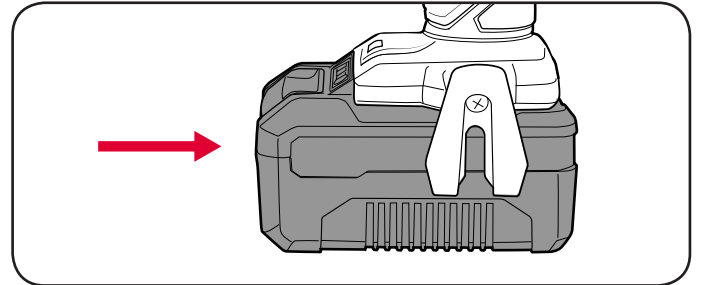

Removing the Battery Pack

- 1 Hold down the battery release button.

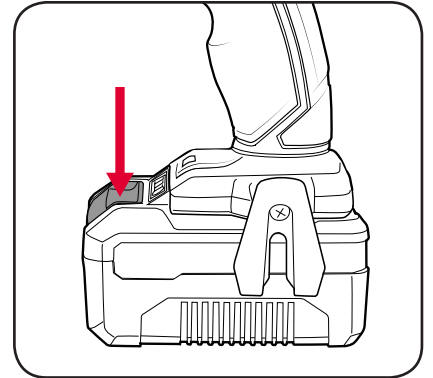

- 2 Slide the battery out.

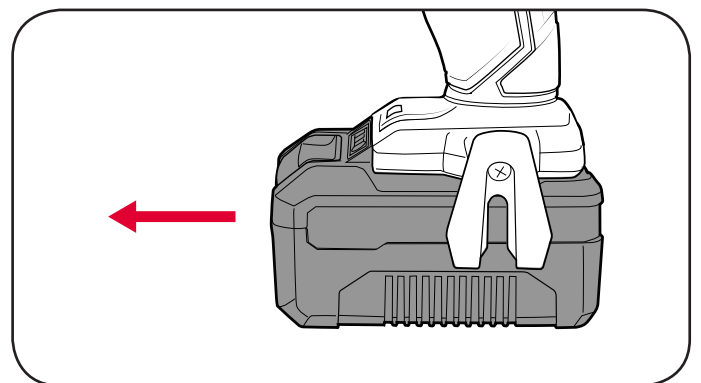

5 YEAR
REPLACEMENT WARRANTY

2. KEYLESS CHUCK

WARNING! ENSURE THE TOOL IS SWITCHED OFF AND THE BATTERY IS REMOVED BEFORE PERFORMING ANY OF THE FOLLOWING TASKS.

Installing a Drill Bit

- 1 Rotate the chuck collar anti-clockwise to open the chuck

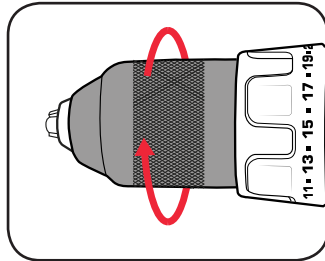

- 2 Insert the drill bit, making sure it is centred in the chuck.

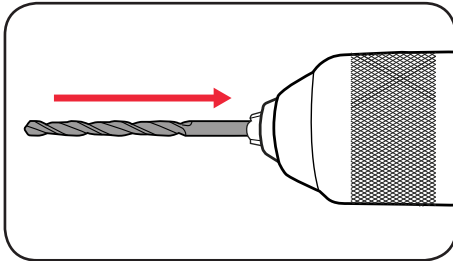

- 3 Tighten the chuck by turning it clockwise.

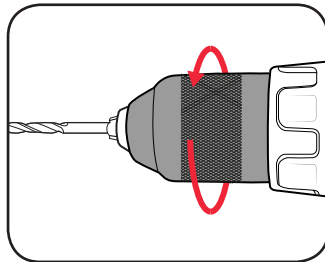

- 4 Pull on the bit to ensure it is firmly secured.

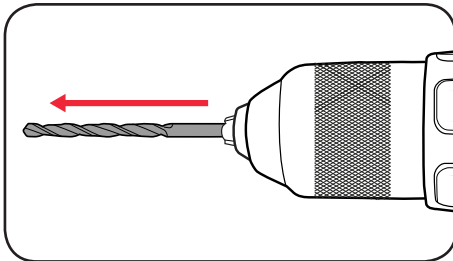

Removing a Drill Bit

- 1 Open the chuck by rotating the chuck collar anti-clockwise and remove the drill bit.

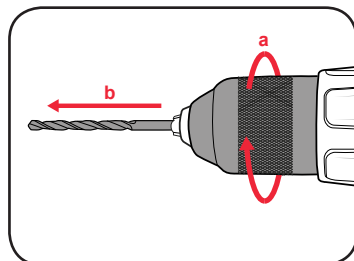

3. CONTROLS

Forward/ Reverse Lever

- 1 For forward rotation, push the fwd/rev lever towards the left side of the drill. For reverse rotation push FWD/REV lever to the right.

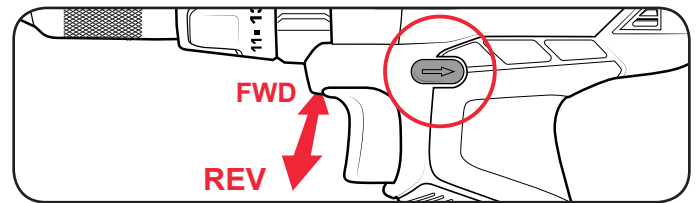

Variable Speed Trigger

- 1 To start drilling squeeze the variable speed trigger.
- 2 To stop drilling release the trigger.

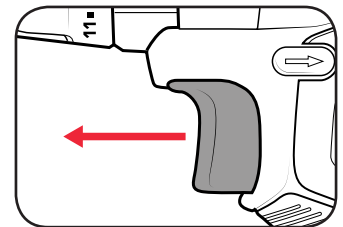
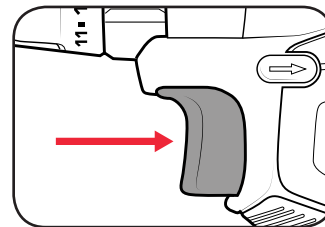

Note: The more the variable speed trigger is depressed, the faster the drill bit will rotate.

CAUTION: TO REDUCE THE RISK OF INJURY WE RECOMMEND THE USE OF GLOVES WHEN HANDLING DRILL BITS.

Speed Control

The gear selector controls the speed of the drill. First gear allows slower drilling with more torque, while second gear is suitable when less torque but higher speed is required.

- 1 Slide the switch forward to select first gear.

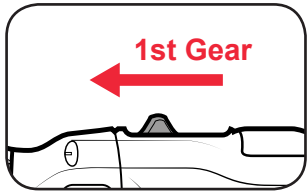

- 2 Slide the switch backward to select second gear.

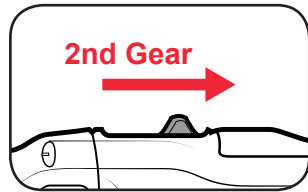

Adjusting Torque

- 1 Rotate the torque collar to the desired setting.

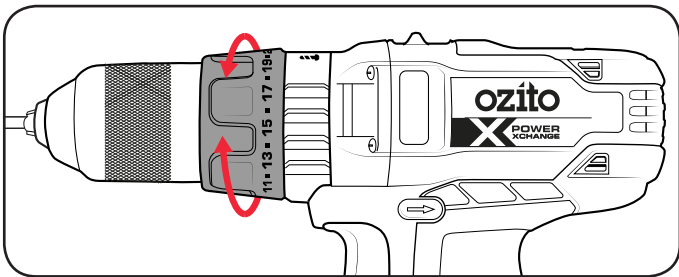

Note: Selecting a higher torque setting will allow the drill to use more torque to drive the screw in or out. To prevent damaging the screw head, it is recommended to start at a low torque setting and increase as necessary.

4. FUNCTIONS

Drilling

- 1 To drill into wood, metal or plastic, turn the function collar and align the arrow on the housing with the drill icon.

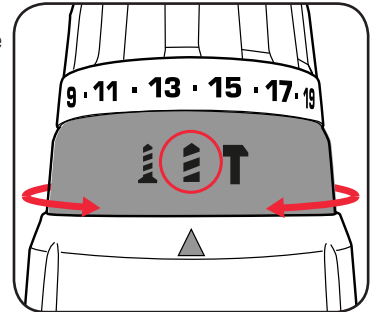

Screwdriving

- 1 To screw into wood, metal or plastic, turn the function collar to align the arrow on the housing with the screw icon. The clutch is then enabled to adjust torque.

Note: 1st gear (low speed) is recommended for screwdriving.

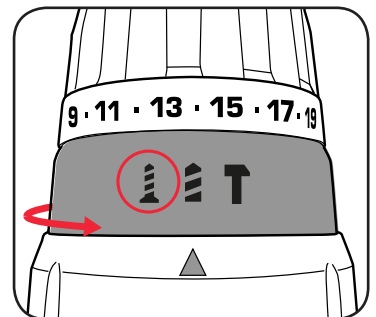

- 2 To adjust the torque, rotate the torque collar to the desired setting.

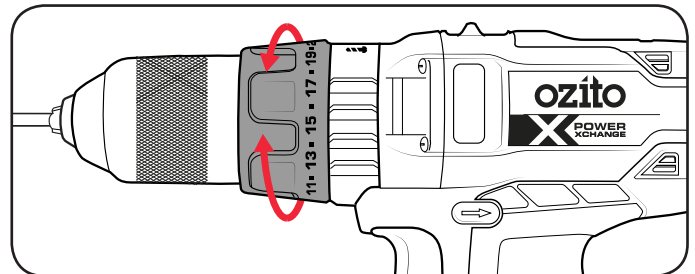

Note: Selecting a higher torque setting will allow the drill to use more torque to drive the screw in or out. To prevent damaging the screw head, it is recommended to start at a low torque setting and increase as necessary.

Hammer Drilling

- 1 To drill into concrete, brick or other masonry, turn the function collar to align the arrow on the housing with the hammer icon.

Note: 2nd gear (high speed) is recommended for hammer drilling.

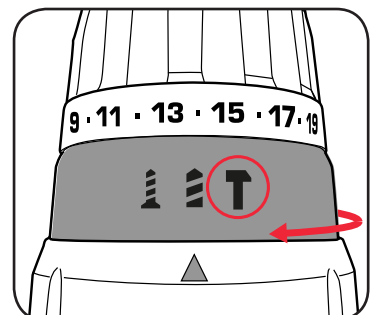

OPERATION

5. DRILLING

Before starting to drill, perform a few simple checks.

- 1 Depress and release the variable speed trigger to ensure it is not locked on.
- 2 Check the FWD/REV lever is on the desired setting.

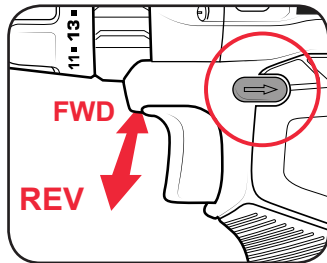
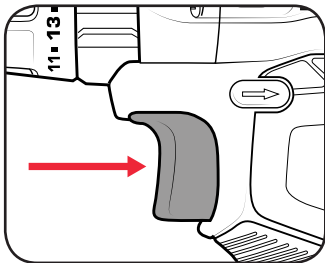

- 3 Secure the material to be drilled in a vice or clamp to stop it turning whilst drilling.

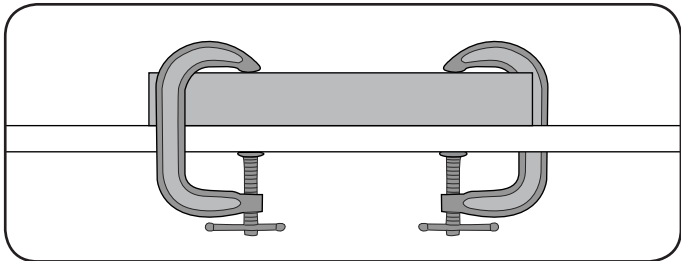

- 4 Hold the drill firmly and place the bit at the point to be drilled.
- 5 Depress the variable speed trigger to start the drill.

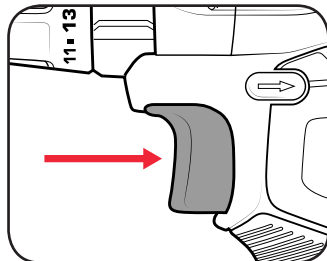
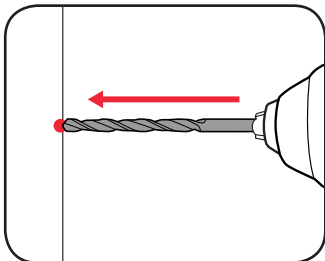

- 6 Move the drill bit into the workpiece.

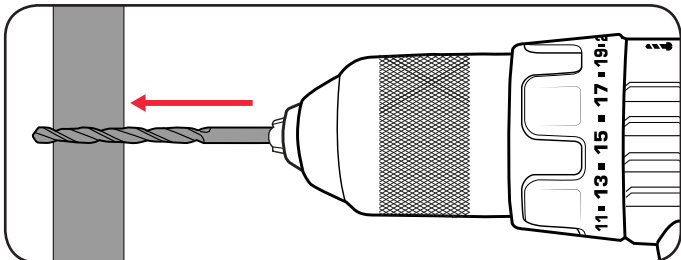

Note: Do not force the drill or apply side pressure to elongate the hole. Let the drill do all the work.

6. HELPFUL TIPS

Drilling to a Preset Depth

A simple way of achieving a hole at a desired depth is to use masking tape.

- 1 Measure along the drill bit to indicate the desired depth
- 2 Wrap a small piece of masking tape tightly around the drill bit.

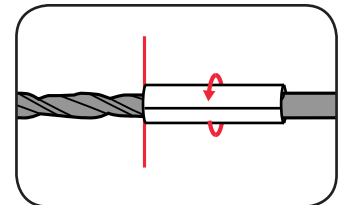
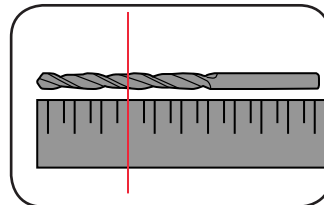

- 3 Drill into the material until the surface reaches the start of the tape..

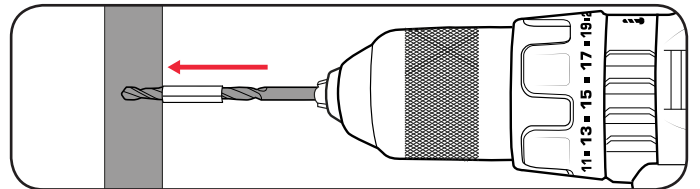

Torque Settings

Torque settings can alter the depth to which you can drill or drive into a surface. To determine the torque setting required to drive a screw perfectly flush to the work surface, follow the steps below.

- 1 Set the torque collar to the lowest setting and tighten the first screw.
- 2 If the clutch ratchets and makes a clicking sound before the screw is flush, increase the torque collar setting and continue tightening.
- 3 Repeat until you reach the correct setting/ screw depth. Use this setting for the remaining screws.

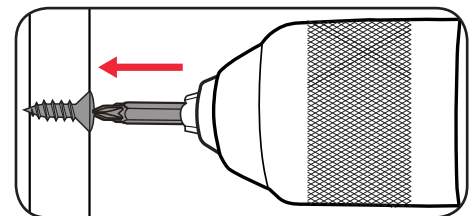
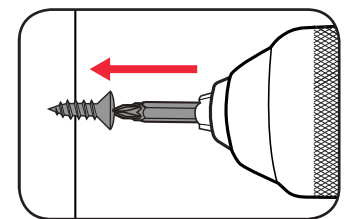
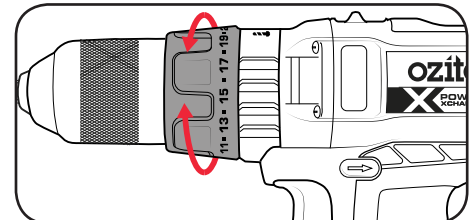

Note: When drilling hard, smooth surfaces, use a centre punch to mark the desired hole location. This measure will prevent the drill bit from slipping off centre as you start the hole.

Note: When drilling metals, use light oil on the drill bit to keep it from overheating. The oil will prolong the life of the bit and increase drilling action.

MAINTENANCE

1. When not in use, the drill should be stored in a dry, frost free location, keep out of children's reach.
2. Keep ventilation slots of the drill clean at all times and prevent anything from entering.
3. If the housing of the drill requires cleaning, do not use solvents. Use of a cloth only is recommended.
4. Blow out the ventilation slots with compressed air periodically .

Note: Ozito Industries will not be responsible for any damage or injuries caused by repair of the drill by an unauthorised person or by mishandling.

Battery protection system

The tool is equipped with the battery protection system, which helps to ensure a long service life.

The output power automatically cuts off during operation when the tool and/or battery are placed under the following situations:

- **When the tool is overloaded:**

If this occurs, release the trigger switch and remove causes of overload, then pull the switch trigger again to restart.

- **When the remaining battery capacity becomes low:**

Recharge the battery pack.

Note: The battery protection system does not in any way damage the tool.

Note: The indicated capacity may be lower than the actual level during use or immediately after using the tool.

TROUBLESHOOTING

LED lights do not illuminate on charger

Check the charging adaptor is securely plugged into the wall outlet.

Check the battery is firmly connected to the charging cradle.

Check that the charging jack is securely connected to the charging cradle.

The battery has a short run time

Ensure the battery is properly charged. It will take 4-5 charging cycles before the battery reaches optimum charge and run time.

Variable speed trigger is locked

Ensure that the forward / reverse lever is in the correct position; pressed left for forwards direction, pressed right for backwards direction. If it is in between the two settings the variable speed trigger will be locked.

The drill is stripping the screw head

Ensure you are starting with a low torque setting and holding the drill securely onto the screw head. Increase the torque setting as required.



Drill has cut out during use

The battery charge could be completely depleted. Place the battery on the charging cradle for 3-5 hours.

Sparking visible through the housing air vents

A small amount of sparking may be visible through the housing vents. This is normal and does not indicate a problem.

DESCRIPTION OF SYMBOLS

V	Volts	Hz	Hertz
ac/~	Alternating current	W	Watts
dc/—	Direct current	∅	Diameter
mA	Milliamperes	Ah	Amp hour
/min	Revolutions per minute	bpm	Beats per minute
	Regulatory Compliance Mark (RCM)	n_o	No load speed
	Warning		Read instruction manual

SPARE PARTS

Spare parts can be ordered from the Special Orders Desk at your local Bunnings Warehouse.

For further information, or any parts not listed here, visit www.ozito.com.au or contact Ozito Customer Service:

Australia 1800 069 486

New Zealand 0508 069 486

E-mail: enquiries@ozito.com.au

CARING FOR THE ENVIRONMENT



Power tools that are no longer usable should not be disposed of with household waste but in an environmentally friendly way. Please recycle where facilities exist. Check with your local council authority for recycling advice.



Recycling packaging reduces the need for landfill and raw materials. Reuse of recycled material decreases pollution in the environment. Please recycle packaging where facilities exist. Check with your local council authority for recycling advice.



ELECTRICAL SAFETY



WARNING! When using mains-powered tools, basic safety precautions, including the following, should always be followed to reduce risk of fire, electric shock, personal injury and material damage.

Read the whole manual carefully and make sure you know how to switch the tool off in an emergency, before operating the tool. Save these instructions and other documents supplied with this tool for future reference.

The charger has been designed for 230V and 240V only. Always check that the power supply corresponds to the voltage on the rating plate.

Note: The supply of 230V and 240V on Ozito tools are interchangeable for Australia and New Zealand.



This tool's charger is double insulated; therefore no earth wire is required.

If the supply cord is damaged, it must be replaced by an electrician or a power tool repairer in order to avoid a hazard.

Note: Double insulation does not take the place of normal safety precautions when operating this tool. The insulation system is for added protection against injury resulting from a possible electrical insulation failure within the tool.

The power supply for this product's charger should be protected by a residual current device (rated at 30mA or less). A residual current device reduces the risk of electric shock.



GENERAL POWER TOOL SAFETY WARNINGS



WARNING! Read all safety warnings and all instructions. Failure to follow the warnings and instructions may result in electric shock, fire and/or serious injury.

Save all warnings and instructions for future reference. The term "power tool" in the warnings refers to your mains-operated (corded) power tool or battery-operated (cordless) power tool.

1. Work area safety

- Keep work area clean and well lit. Cluttered or dark areas invite accidents.
- Do not operate power tools in explosive atmospheres, such as in the presence of flammable liquids, gases or dust. Power tools create sparks which may ignite the dust or fumes.
- Keep children and bystanders away while operating a power tool. Distractions can cause you to lose control.

2. Electrical safety

- Power tool plugs must match the outlet. Never modify the plug in any way. Do not use any adapter plugs with earthed (grounded) power tools. Unmodified plugs and matching outlets will reduce risk of electric shock.
- Avoid body contact with earthed or grounded surfaces, such as pipes, radiators, ranges and refrigerators. There is an increased risk of electric shock if your body is earthed or grounded.
- Do not expose power tools to rain or wet conditions. Water entering a power tool will increase the risk of electric shock.
- Do not abuse the cord. Never use the cord for carrying, pulling or unplugging the power tool. Keep cord away from heat, oil, sharp edges or moving parts. Damaged or entangled cords increase the risk of electric shock.
- When operating a power tool outdoors, use an extension cord suitable for outdoor use. Use of a cord suitable for outdoor use reduces the risk of electric shock.

3. Personal safety

- Stay alert, watch what you are doing and use common sense when operating a power tool. Do not use a power tool while you are tired or under the influence of drugs, alcohol or medication. A moment of inattention while operating power tools may result in serious personal injury.
- Use personal protective equipment. Always wear eye protection. Protective equipment such as dust mask, non-skid safety shoes, hard hat, or hearing protection used for appropriate conditions will reduce personal injuries.
- Prevent unintentional starting. Ensure the switch is in the off-position before connecting to power source and/or battery pack, picking up or carrying the tool. Carrying power tools with your finger on the switch or energising power tools that have the switch on invites accidents.
- Remove any adjusting key or wrench before turning the power tool on. A wrench or a key left attached

to a rotating part of the power tool may result in personal injury.

- Do not overreach. Keep proper footing and balance at all times. This enables better control of the power tool in unexpected situations.
- Dress properly. Do not wear loose clothing or jewellery. Keep your hair, clothing and gloves away from moving parts. Loose clothes, jewellery or long hair can be caught in moving parts.
- If devices are provided for the connection of dust extraction and collection facilities, ensure these are connected and properly used. Use of dust collection can reduce dust-related hazards.
- Do not let familiarity gained from frequent use of tools allow you to become complacent and ignore tool safety principles. A careless action can cause severe injury within a fraction of a second.

4. Power tool use and care

- Do not force the power tool. Use the correct power tool for your application. The correct power tool will do the job better and safer at the rate for which it was designed.
- Do not use the power tool if the switch does not turn it on and off. Any power tool that cannot be controlled with the switch is dangerous and must be repaired.
- Disconnect the plug from the power source and/or the battery pack from the power tool before making any adjustments, changing accessories, or storing power tools. Such preventive safety measures reduce the risk of starting the power tool accidentally.
- Store idle power tools out of the reach of children and do not allow persons unfamiliar with the power tool or these instructions to operate the power tool. Power tools are dangerous in the hands of untrained users.
- Maintain power tools. Check for misalignment or binding of moving parts, breakage of parts and any other condition that may affect the power tool's operation. If damaged, have the power tool repaired before use. Many accidents are caused by poorly maintained power tools.
- Keep cutting tools sharp and clean. Properly maintained cutting tools with sharp cutting edges are less likely to bind and are easier to control.
- Use the power tool, accessories and tool bits etc. in accordance with these instructions, taking into account the working conditions and the work to be performed. Use of the power tool for operations different from those intended could result in a hazardous situation.
- Keep handles and grasping surfaces dry, clean and free from oil and grease. Slippery handles and grasping surfaces do not allow for safe handling and control of the tool in unexpected situations.

5. Service

- Have your power tool serviced by a qualified repair person using only identical replacement parts. This will ensure that the safety of the power tool is maintained.



HAMMER DRILL SAFETY WARNINGS



WARNING! Wear ear protectors when drilling. Exposure to noise can cause hearing loss.

Use auxiliary handle(s), if supplied with the tool. Loss of control can cause personal injury.

Hold power tool by insulated gripping surfaces, when performing an operation where the cutting accessory may contact hidden wiring or its own cord. Cutting accessory contacting a "live" wire may make exposed metal parts of the power tool "live" and could give the operator an electric shock.

Before drilling into walls, ceilings etc, ensure that there are no concealed power cables or pipes in the cavity.



WARNING! Some dust created by power sanding, sawing, grinding, drilling and other construction activities contains chemicals known to cause cancer, birth defects or other reproductive harm. Some examples of these chemicals are:

- Lead from lead-based paints
- Crystalline silica from bricks and cement and other masonry products
- Arsenic and chromium from chemically treated timber

Your risk from exposure to these chemicals varies, depending on how often you do this type of work. To reduce your exposure to these chemicals: work in a well ventilated area and work with approved safety equipment, such as dust masks that are specially designed to filter out microscopic particles.

This appliance is not intended for use by young or infirm persons unless supervised by a responsible person to ensure that they can use the appliance safely. Young children should be supervised to ensure that they do not play with the appliance.



18V LITHIUM ION

3.0Ah BATTERY

INSTRUCTION MANUAL

SPECIFICATIONS

Input:	18V
Battery Capacity:	3.0Ah Li-ion
Power Consumption:	54Wh
Weight:	0.60kg

ozito.com.au

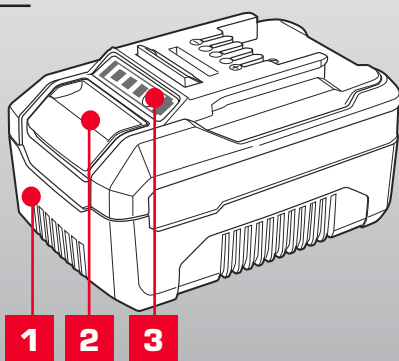

1. Battery
2. Battery Release Button
3. Charge Indicator Button

3 YEAR
REPLACEMENT WARRANTY

PXBP-300

DESCRIPTION OF SYMBOLS

V	Volts	Hz	Hertz
ac/~	Alternating Current	W	Watts
dc	Direct Current	Ah	Amp Hour
mA	Milliamperes		Warning
	Lithium Ion Battery		Do not store or use battery in temperatures exceeding 50°C
	Recycle Battery		Do not put in the rubbish
	Do not incinerate		Do not get battery wet
	Regulatory Compliance Mark (RCM)		Do not store battery when the charge is low; store between 40-60%.

CARING FOR THE ENVIRONMENT



Power tools that are no longer usable should not be disposed of with household waste but in an environmentally friendly way. Please recycle where facilities exist. Check with your local council authority for recycling advice.



Recycling packaging reduces the need for landfill and raw materials. Reuse of recycled material decreases pollution in the environment. Please recycle packaging where facilities exist. Check with your local council authority for recycling advice.

BATTERY SAFETY WARNINGS

THIS MANUAL CONTAINS IMPORTANT SAFETY AND OPERATING INSTRUCTIONS FOR YOUR BATTERY.

1. Before using the charger read all instructions and cautionary markings on the charger, battery pack and the product using the battery pack.
2. This charger is not intended for any uses other than charging Ozito Power X Change rechargeable batteries. Any other use may result in risk of fire, electric shock or electrocution.
3. Do not place any object on top of the charger or place the charger on a soft surface that may result in excessive internal heat. Place the charger in a position away from any heat source.
4. To reduce risk of damage to the electric plug and cord, pull by the plug rather than the cord when disconnecting the charger.
5. Make sure the cord is located so that it will not be stepped on, tripped over, or otherwise subjected to damage or stress.
6. An extension cord should not be used unless absolutely necessary. Use of an improper extension cord could result in the risk of fire, electric shock or electrocution.
7. Do not operate the charger if it has received a sharp blow, been dropped or otherwise damaged in any way. Have it checked by an electrician or power tool repairer.
8. Do not disassemble charger. Take it to an electrician or power tool repairer when service or repair is required. Incorrect reassembly may result in a risk of electric shock, electrocution or fire.
9. To reduce risk of electric shock, unplug the charger from the outlet before attempting any cleaning. Removing the battery pack will not reduce this risk.
10. Never attempt to connect 2 chargers together.
11. The charger is designed to operate on standard household electrical power (240 volts). Do not attempt to use it on any other voltage!
12. The battery pack is not fully charged out of the carton. First read the safety instructions and then follow the charging notes and procedures.
13. DO NOT STORE OR USE the battery pack in locations where the temperature may reach below 0°C or exceed 50°C (such as inside sheds or metal buildings in summer). This is important and will prevent damage to the battery pack.
14. Do not incinerate the battery pack even if it is seriously damaged or is completely worn out. The battery can explode in a fire.
15. Never attempt to open the battery pack for any reason. If the plastic housing of the battery pack breaks or cracks, immediately discontinue use and do not recharge.
16. During charging, the battery must be placed in a well ventilated area.

ELECTRICAL SAFETY

WARNING! When using mains-powered tools, basic safety precautions, including the following, should always be followed to reduce risk of fire, electric shock, personal injury and material damage.

Read the whole manual carefully and make sure you know how to switch the tool off in an emergency, before operating the tool.

Save these instructions and other documents supplied with this tool for future reference.

Note: The supply of 230V and 240V on Ozito tools are interchangeable for Australia and New Zealand.



This tool's charger is double insulated therefore no earth wire is required.

If the supply cord is damaged, it must be replaced by the manufacturer, its service agent or similarly qualified persons in order to avoid hazard.

Note: Double insulation does not take the place of normal safety precautions when operating this tool. The insulation system is for added protection against injury resulting from a possible electrical insulation failure within the tool.

Using an Extension Lead

Always use an approved extension lead suitable for the power input of this tool. Before use, inspect the extension lead for signs of damage, wear and ageing. Replace the extension lead if damaged or defective.

When using an extension lead on a reel, always unwind the lead completely. Use of an extension lead not suitable for the power input of the tool or which is damaged or defective may result in a risk of fire and electric shock.

To reduce the risk of electric shock, we recommend the use of a residual current device (rated 30mA or less).

This appliance is not intended for use by persons (including children) with reduced physical, sensory or mental capabilities, or lack of experience and knowledge, unless they have been given supervision or instruction concerning use of the appliance by a person responsible for their safety.

Children should be supervised to ensure that they do not play with the appliance.

1. OPERATION

Only use the battery pack with Ozito Power X Change 18V cordless products.

CHARGING YOUR LITHIUM ION BATTERY

This battery has been shipped in a low charge condition, and requires charging prior to use. Allow several cycles of charging and discharging (through use with a compatible tool) for the battery to reach its optimum performance / runtime.

This battery is compatible with chargers from the 18V Ozito Power X Change range available through your local Bunnings Warehouse. Product availability may differ.

1. Insert the power plug of the charger into the mains socket outlet. The green LED will begin to flash when properly connected to power supply.
2. Insert the battery pack into the battery charger .
3. Remove battery from the charger once fully charged. Disconnect the charger from the power supply.

Note: The battery pack can become a little warm during the charging. This is normal.

If the battery pack fails to charge, check:

- if there is voltage at the socket outlet
- that the battery and charger are properly connected.

If the battery pack still fails to charge, please contact our customer service center.

BATTERY CHARGE INDICATOR

The purchased battery is equipped with a battery charge indicator to show the state of the battery charge.

Press the charge indicator button and look to see which LED lights.

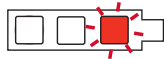
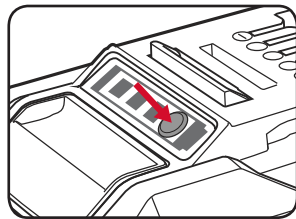

Battery requires immediate charging



Low state of charge, requires charging soon.

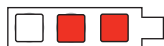

Mid state of charge



Full state of charge.

Note: The battery needs to be removed from the tool to check the state of charge.

BATTERY PROTECTION SYSTEM

The tool is equipped with a battery protection system, which helps to ensure longevity of the battery.

The output power automatically cuts off during operation when the tool and/or battery are placed under the following situations:

- When the tool is overloaded:
If this occurs, release the trigger switch and remove causes of overload, then pull the switch trigger again to restart.
- When the remaining battery capacity becomes low:
Recharge the battery pack.

Note: The battery protection system does not in any way damage the tool.

Note: The indicated capacity may be lower than the actual level during use or immediately after using the tool.

WARRANTY

IN ORDER TO MAKE A CLAIM UNDER THIS WARRANTY YOU MUST RETURN THE PRODUCT TO YOUR NEAREST BUNNINGS WAREHOUSE WITH YOUR BUNNINGS REGISTER RECEIPT. PRIOR TO RETURNING YOUR PRODUCT FOR WARRANTY PLEASE TELEPHONE OUR CUSTOMER SERVICE HELPLINE:

Australia 1800 069 486

New Zealand 0508 069 486

TO ENSURE A SPEEDY RESPONSE PLEASE HAVE THE MODEL NUMBER AND DATE OF PURCHASE AVAILABLE. A CUSTOMER SERVICE REPRESENTATIVE WILL TAKE YOUR CALL AND ANSWER ANY QUESTIONS YOU MAY HAVE RELATING TO THE WARRANTY POLICY OR PROCEDURE.

The benefits provided under this warranty are in addition to other rights and remedies which are available to you at law.

Our goods come with guarantees that cannot be excluded at law. You are entitled to a replacement or refund for a major failure and for compensation for any other reasonably foreseeable loss or damage. You are also entitled to have the goods repaired or replaced if the goods fail to be of acceptable quality and the failure does not amount to a major failure.

Generally you will be responsible for all costs associated with a claim under this warranty, however, where you have suffered any additional direct loss as a result of a defective product you may be able to claim such expenses by contacting our customer service helpline above.

36 MONTH REPLACEMENT WARRANTY

Your product is guaranteed for a period of **36 months from the original date of purchase** and is intended for DIY (Do It Yourself) use only. If a product is defective it will be replaced in accordance with the terms of this warranty. Warranty excludes consumable parts.

WARNING

The following actions will result in the warranty being void.

- If the tool has been operated on a supply voltage other than that specified on the tool.
- If the tool shows signs of damage or defects caused by or resulting from abuse, accidents or alterations.
- Failure to perform maintenance as set out within the instruction manual.
- If the tool is disassembled or tampered with in any way.

0219

ONLINE MANUAL

Scan this QR Code with your mobile device to take you to the online manual.



OZITO Australia/New Zealand (Head Office)
1-23 Letcon Drive, Bangholme, Victoria, Australia 3175.

PXBP-300



18V LITHIUM ION

FAST CHARGER

INSTRUCTION MANUAL

SPECIFICATIONS

Input:	200-250V ~AC 50-60Hz
Output:	21V DC, 3A
Battery Charge Time:	30Min - PXBP-150 (18V 1.5Ah)
	40Min - PXBP-200 (18V 2.0Ah)
	60Min - PXBP-300 (18V 3.0Ah)
	75Min - PXBP-400 (18V 4.0Ah)
	120Min - PXBP-520 (18V 5.2Ah)
	100Min - PXUBP-520 (18V 5.2Ah Ultra)

ozito.com.au

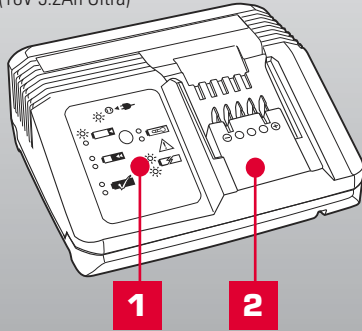

1. Charging Unit
2. Charging Unit LED

3 YEAR
REPLACEMENT WARRANTY

PXCG-030

DESCRIPTION OF SYMBOLS

V	Volts	Hz	Hertz
A	Amperes	Ah	Amp Hour
	Read Instruction Manual		Double Insulated
	Indoor Use Only		Do not dispose of in rubbish
	Do not charge battery in temperatures exceeding 40°C		Regulatory Compliance Mark (RCM)
	3.15A Slow Blow Fuse		Warning

CARING FOR THE ENVIRONMENT



Power tools that are no longer usable should not be disposed of with household waste but in an environmentally friendly way. Please recycle where facilities exist. Check with your local council authority for recycling advice.



Recycling packaging reduces the need for landfill and raw materials. Reuse of recycled material decreases pollution in the environment. Please recycle packaging where facilities exist. Check with your local council authority for recycling advice.

⚠ CHARGER SAFETY WARNINGS

THIS MANUAL CONTAINS IMPORTANT SAFETY AND OPERATING INSTRUCTIONS FOR YOUR CHARGER.

1. Before using the charger read all instructions and cautionary markings on the charger, battery pack and the product using the battery pack.
2. This charger is not intended for any uses other than charging Ozito Power X Change rechargeable batteries. Any other use may result in risk of fire, electric shock or electrocution.
3. Do not place any object on top of the charger or place the charger on a soft surface that may result in excessive internal heat. Place the charger in a position away from any heat source.
4. To reduce risk of damage to the electric plug and cord, pull by the plug rather than the cord when disconnecting the charger.
5. Make sure the cord is located so that it will not be stepped on, tripped over, or otherwise subjected to damage or stress.
6. An extension cord should not be used unless absolutely necessary. Use of an improper extension cord could result in the risk of fire, electric shock or electrocution.
7. Do not operate the charger if it has received a sharp blow, been dropped or otherwise damaged in any way. Have it checked by an electrician or power tool repairer.
8. Do not disassemble charger. Take it to an electrician or power tool repairer when service or repair is required. Incorrect reassembly may result in a risk of electric shock, electrocution or fire.
9. To reduce risk of electric shock, unplug the charger from the outlet before attempting any cleaning. Removing the battery pack will not reduce this risk.
10. Never attempt to connect 2 chargers together.
11. The charger is designed to operate on standard household electrical power (240 volts). Do not attempt to use it on any other voltage!
12. DO NOT USE the charger where the temperature may reach below 0° or exceed 40°C. If the battery pack is too hot or too cold charging will cease and begin automatically only when battery reaches correct charging temperature.
13. Do not incinerate the battery pack even if it is seriously damaged or is completely worn out. The battery can explode in a fire.
14. Never attempt to open the battery pack for any reason. If the plastic housing of the battery pack breaks or cracks, immediately discontinue use and do not recharge.
15. During charging, the battery must be placed in a well ventilated area.

⚠ ELECTRICAL SAFETY

⚠ WARNING! When using mains-powered tools, basic safety precautions, including the following, should always be followed to reduce risk of fire, electric shock, personal injury and material damage. Read the whole manual carefully and make sure you know how to switch the tool off in an emergency, before operating the tool. Save these instructions and other documents supplied with this tool for future reference.

Note: The supply of 230V and 240V on Ozito tools are interchangeable for Australia and New Zealand.



This tools charger is double insulated therefore no earth wire is required.

If the supply cord is damaged, it must be replaced by the manufacturer, its service agent or similarly qualified persons in order to avoid hazard.

Note: Double insulation does not take the place of normal safety precautions when operating this tool. The insulation system is for added protection against injury resulting from a possible electrical insulation failure within the tool.

Using an Extension Lead

Always use an approved extension lead suitable for the power input of this tool. Before use, inspect the extension lead for signs of damage, wear and ageing. Replace the extension lead if damaged or defective.

When using an extension lead on a reel, always unwind the lead completely. Use of an extension lead not suitable for the power input of the tool or which is damaged or defective may result in a risk of fire and electric shock.

To reduce the risk of electric shock, we recommend the use of a residual current device (rated 30mA or less).

This appliance is not intended for use by persons (including children) with reduced physical, sensory or mental capabilities, or lack of experience and knowledge, unless they have been given supervision or instruction concerning use of the appliance by a person responsible for their safety.

Children should be supervised to ensure that they do not play with the appliance.

ONLINE MANUAL

Scan this QR Code with your mobile device to take you to the online manual.



1. CHARGING A BATTERY



CAUTION: THE CHARGER SHOULD BE PROTECTED BY A RESIDUAL CURRENT DEVICE (RATED AT 30MA OR LESS).

1. Connect the charger to the power supply and the LED will flash green showing power is being supplied to the charger.

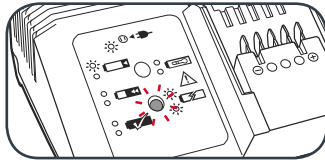

2. Align and then slide the ribs on the battery into the recess in the charger.

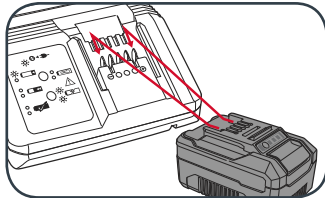

3. The red LED will illuminate while the battery charges.

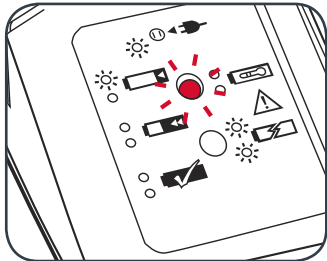

4. The green LED will illuminate once the battery is charged.

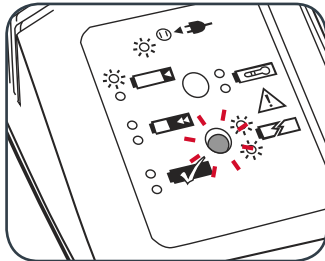

Charger LED Indicator Lights

LED Indicator	Situation
GREEN (Flashing)	Stand By (no battery pack is inserted)
RED (Flashing)	Battery is charging (low charge)
RED (Illuminated)	Battery is fast charging (mid charge)
GREEN (Illuminated)	Battery is 85% - 100% charged and is ready for use.
BOTH (Illuminated)	Battery pack is too hot or too cold (charging will begin automatically when battery reaches correct charging temperature).
BOTH (Flashing)	The battery is defective, charging is no longer possible. Do not charge. Contact Ozito Customer Service.

Mounting The Charging Unit On A Wall

The charging unit can be mounted to a wall or workbench. The correct dimensions for drill holes can be found on the back of the charging unit; a template for the mounting hole locations can also be found on the Ozito website.

Note: When mounting on a wall you must use suitable screws, e.g.M3 pan-head screws, in order to prevent damage to the housing and risk of falling.

2. MAINTENANCE

- Disconnect the charger from power source before cleaning.
- Keep the charger in a dry place out of reach of children.
- If the enclosure of the charger requires cleaning, do not use solvents. Use a dry, soft cloth only to wipe down the surface. Never let any liquid get inside the charger; never immerse any part of the charger.
- There are no other parts inside the charger which require maintenance. Do not take the charger apart. If the charger is damaged, contact your supplier or the manufacturer.

WARRANTY

IN ORDER TO MAKE A CLAIM UNDER THIS WARRANTY YOU MUST RETURN THE PRODUCT TO YOUR NEAREST BUNNINGS WAREHOUSE WITH YOUR BUNNINGS REGISTER RECEIPT. PRIOR TO RETURNING YOUR PRODUCT FOR WARRANTY PLEASE TELEPHONE OUR CUSTOMER SERVICE HELPLINE:

Australia 1800 069 486

New Zealand 0508 069 486

TO ENSURE A SPEEDY RESPONSE PLEASE HAVE THE MODEL NUMBER AND DATE OF PURCHASE AVAILABLE. A CUSTOMER SERVICE REPRESENTATIVE WILL TAKE YOUR CALL AND ANSWER ANY QUESTIONS YOU MAY HAVE RELATING TO THE WARRANTY POLICY OR PROCEDURE.

The benefits provided under this warranty are in addition to other rights and remedies which are available to you at law.

Our goods come with guarantees that cannot be excluded at law. You are entitled to a replacement or refund for a major failure and for compensation for any other reasonably foreseeable loss or damage. You are also entitled to have the goods repaired or replaced if the goods fail to be of acceptable quality and the failure does not amount to a major failure.

Generally you will be responsible for all costs associated with a claim under this warranty, however, where you have suffered any additional direct loss as a result of a defective product you may be able to claim such expenses by contacting our customer service helpline above.

36 MONTH REPLACEMENT WARRANTY

Your product is guaranteed for a period of **36 months from the original date of purchase** and is intended for DIY (Do It Yourself) use only. If a product is defective it will be replaced in accordance with the terms of this warranty. Warranty excludes consumable parts.

WARNING

The following actions will result in the warranty being void.

- If the tool has been operated on a supply voltage other than that specified on the tool.
- If the tool shows signs of damage or defects caused by or resulting from abuse, accidents or alterations.
- Failure to perform maintenance as set out within the instruction manual.
- If the tool is disassembled or tampered with in any way.