

ITEM NO.	PART NUMBER	DESCRIPTION	QTY.
1	121.99.00.20	Tile-Over Tray 1200x900 Centre Outlet	1

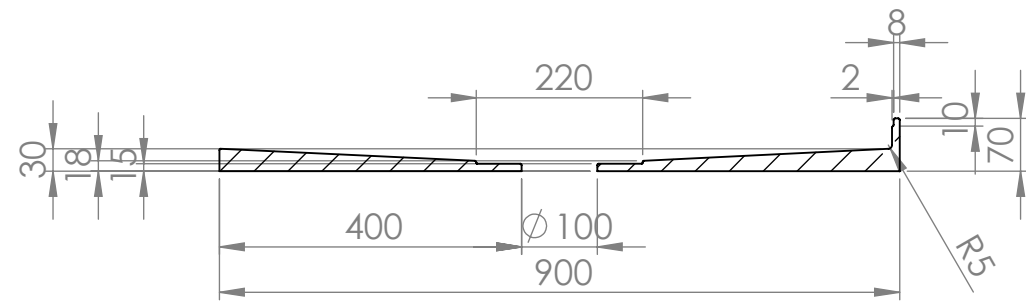

SECTION A-A

CROSS SECTION VIEW

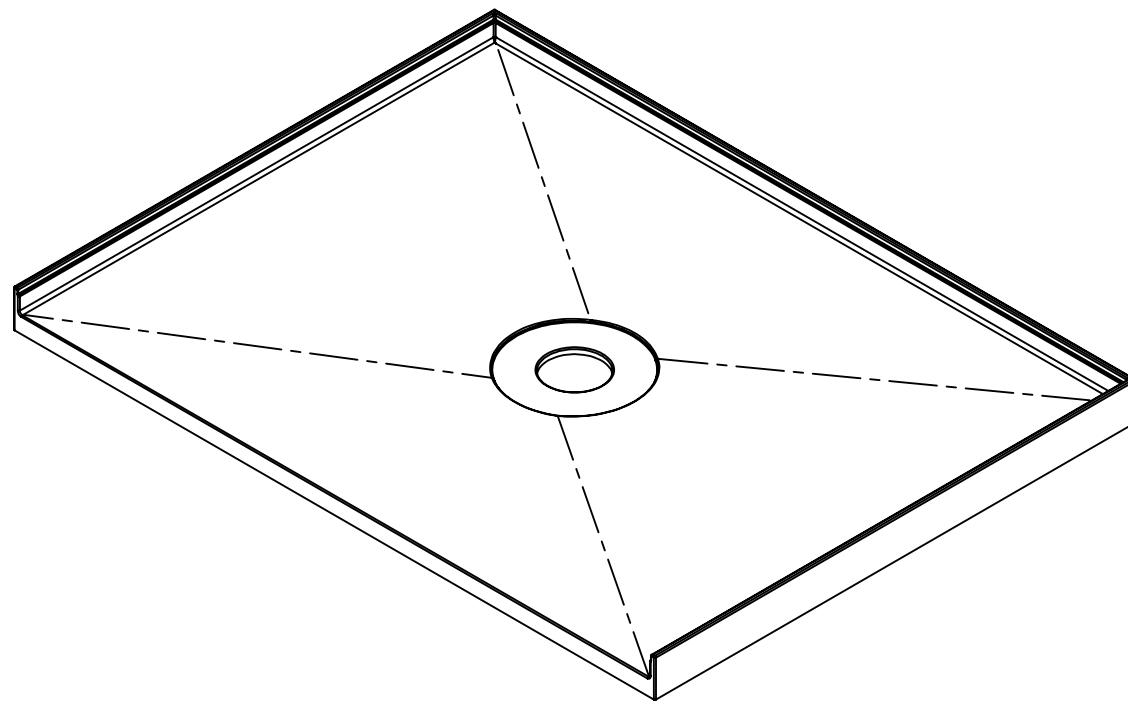

ISOMETRIC VIEW

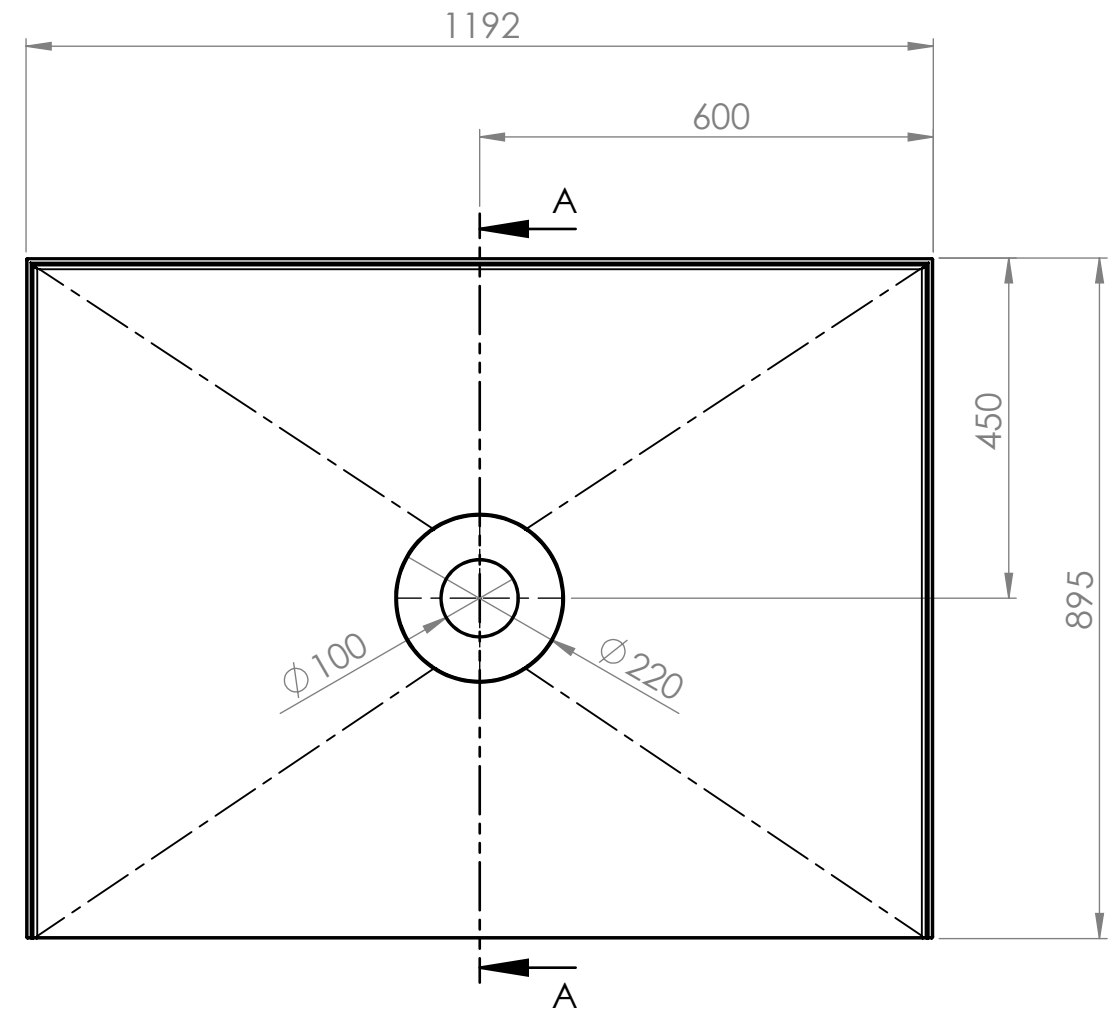

TOP VIEW

 Showerline 5 Kim Court North Geelong VIC 3215 Phone: 1800 688 745 Fax: n/a Email: n/a Website: www.showerline.com.au	Material:	DO NOT SCALE DRAWING		REVISION 1.0
	High Density Polyurethane	TITLE:		
	Part Number:	Tile-Over Tray 1200x900 Centre Outlet (3Sided) DRAWING rev 1.0		
	121.99.00.20	SIZE	DWG NO.	A3
UNLESS OTHERWISE SPECIFIED: DIMENSIONS ARE IN MILLIMETERS SURFACE FINISH: TOLERANCES: 5mm ALL FILLETS 2mm UNLESS SPECIFIED	A	9 of 12	PAGE: 1	
Draw and prepared by	SCALE: 1:10			This drawing and design belongs to Showerline Patent (prov.) 2012904805
NAME SIGNATURE DATE				
Jason Duong	17/07/2017			

