

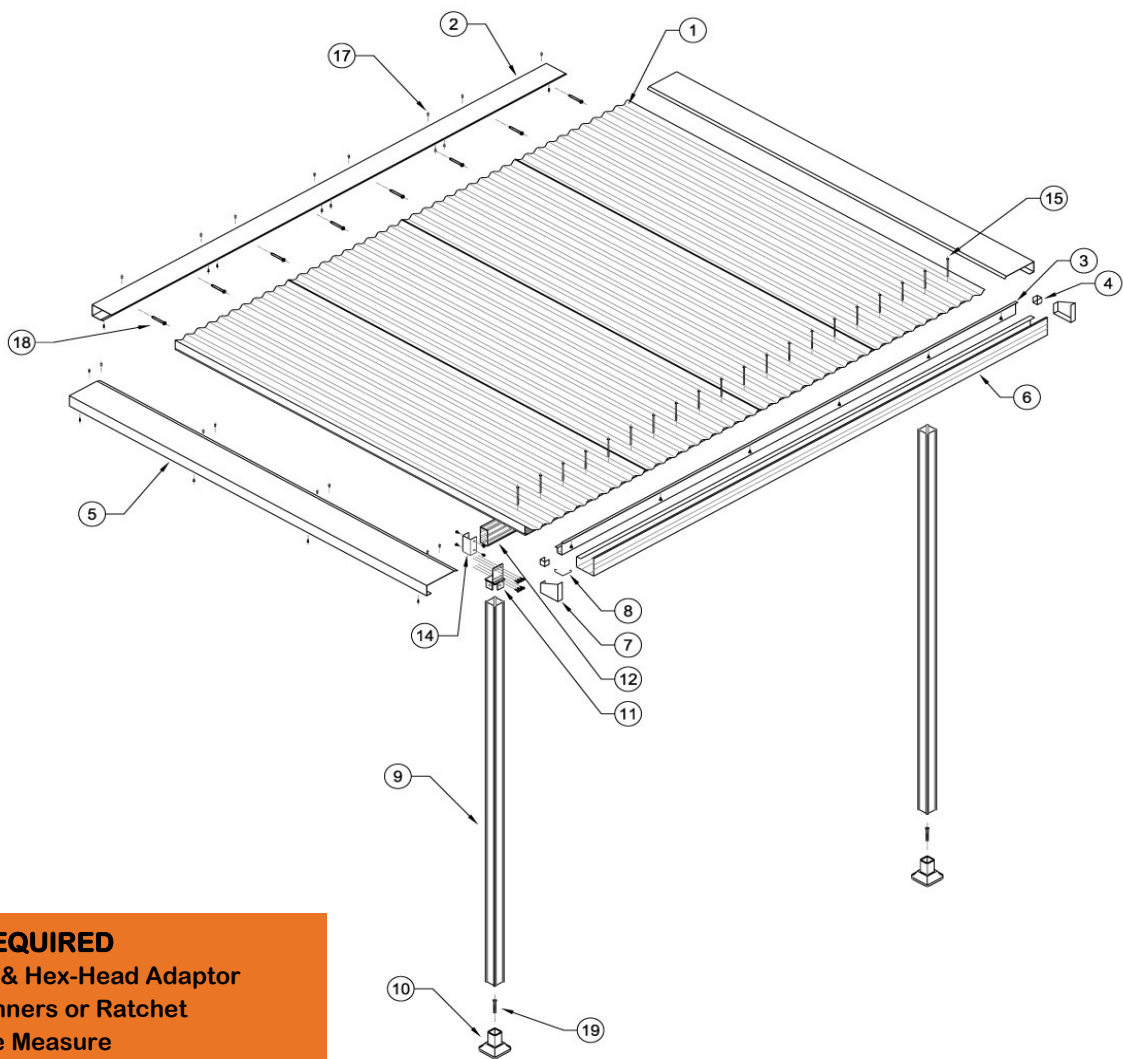

## ATTACHED INSULATED ROOF for VERANDAH / AWNING / PATIO

Your complete guide to building an  
attached verandah, awning or patio



### TOOLS REQUIRED

- Drill & Hex-Head Adaptor
- Spanners or Ratchet
- Tape Measure
- Spirit Level
- Silicone Gun
- Neutral-cure silicone
- Ladder
- Hacksaw
- Rivet Gun
- Tin Snips
- Stringline
- Adjustable Construction Props

Distributed by:

1.0 LAYOUT OF COMPONENTS FOR A SINGLE ROOF

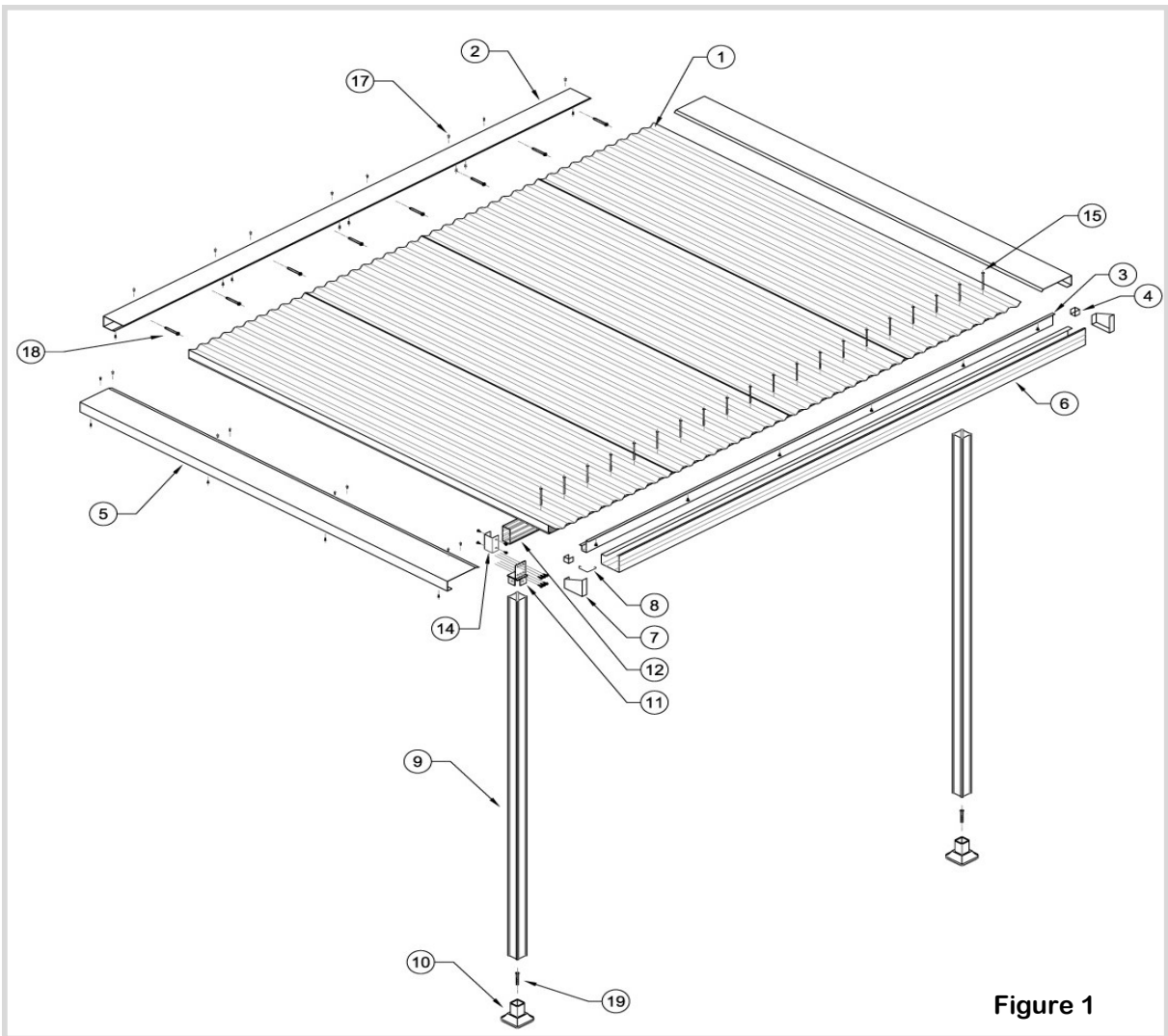

Figure 1

LIST OF SUPPLIED COMPONENTS AND QUANTITIES

Item	Component	Qty	Item	Component	Qty
1	Insulspan (roof panel)	4	11	Post / Beam Connectors	2
2	Receiver Channel	1	12	Beam	1
3	'Z' Flashing	1	13	Beam Join Connectors	0
4	Z' Flashing End Cap	2	14	Beam End Caps	2
5	Barge Capping	2	15	Screw SD Hex Neo Class 4 14-20x115	20
6	Gutter	1	16	Rivets A/S 5-4 Surfmist	200
7	Gutter End Caps	2	17	Wafer Head 10-16 x 16 Class 4 Colour	100
8	Gutter Brackets	3	18	M8 x 90mm Galvanised Dynabolts	8
9	Posts	2	19	M12 x 115mm Galvanised Dynabolts	2
10	Post Base	2			

# ATTACHED ROOF

## 2.0 PARTS DESCRIPTION

1 Insulspan

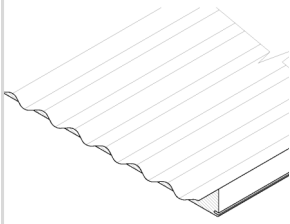

2 Receiver Channel

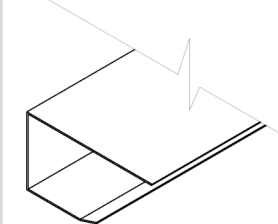

3 'Z' Flashing

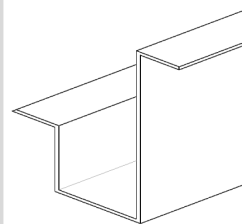

4 Z' Flashing End Cap

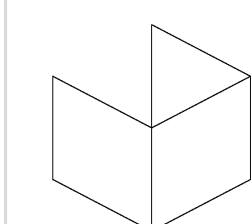

5 Barge Capping

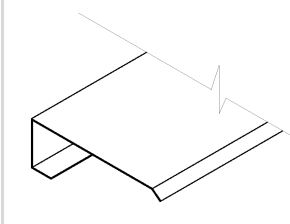

6 Gutter

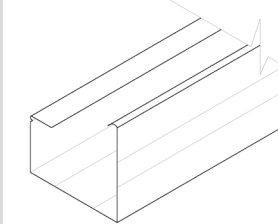

7 Gutter End Caps

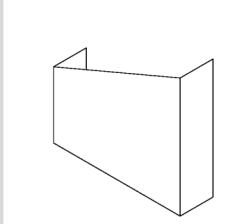

8 Gutter Brackets

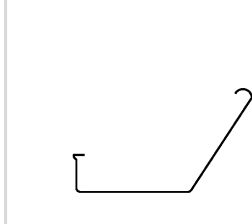

9 Posts

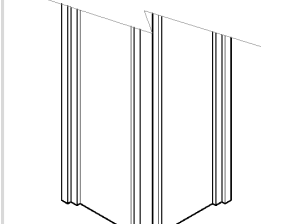

10 Post Base

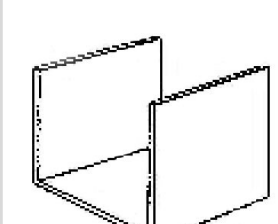

11 Post / Beam Connectors

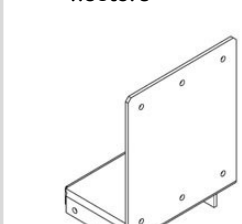

12 Beam

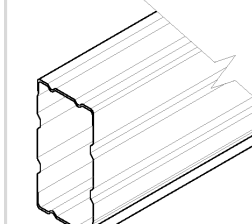

13 Beam Join Connectors

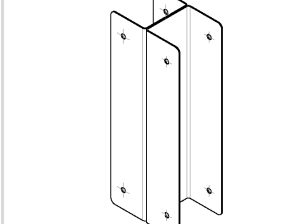

14 Beam End Caps

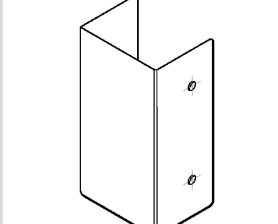

15 Screw SD Hex Neo Class 4 14-20x115

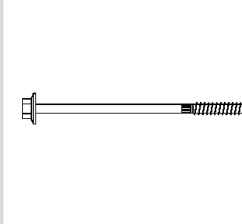

16 Rivets A/S 5-4 Surfmist

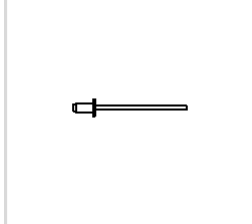

17 Wafer Head 10-16 x 16 Class 4 Colour

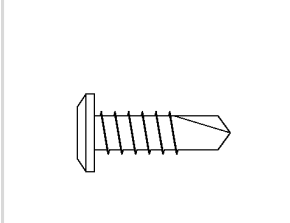

18 M8 x 90mm Galvanised Dynabolts

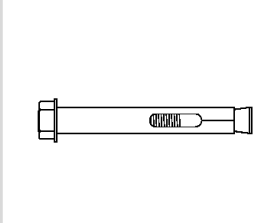

19 M12 x 115mm Galvanised Dynabolts

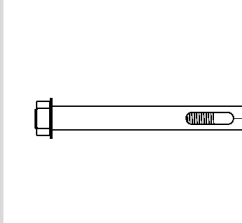

### 3.0 OVERVIEW OF INSTALLATION PROCEDURE FOR ATTACHED ROOF

The attached roof is secured to the building wall and concrete slab as shown in Figure 2

The steps to install the attached roof are generally as follows:

- Install the receiver channel (item 2) Install both post bases (item 10) onto the concrete slab If required, cut the posts (item 9) to length
- On the ground, install the beam end caps (item 14) and connect the beam (item 12) to both posts.
- Lift the assembled beam and posts into position on the post caps and temporarily brace the posts.
- Install barge capping (item 5) to one side of the first section of roof panel (item 1)
- Lift the first section of roof panel into the receiver channel and secure
- Install the second section of roof panel.
- Continue installing the remaining roof panels in the same manner.
- Before installing the last section of roof panel, remove the corrugated overlap by cutting.
- Install the barge capping (item 5) onto the last section of roof panel
- Install the last section of roof panel into the receiver channel
- Secure the roof panels to the beam
- Install Z flashing (item 3) and Z flashing end caps (item 4)
- Install gutter, gutter end caps, and gutter brackets (items 6, 7 & 8)

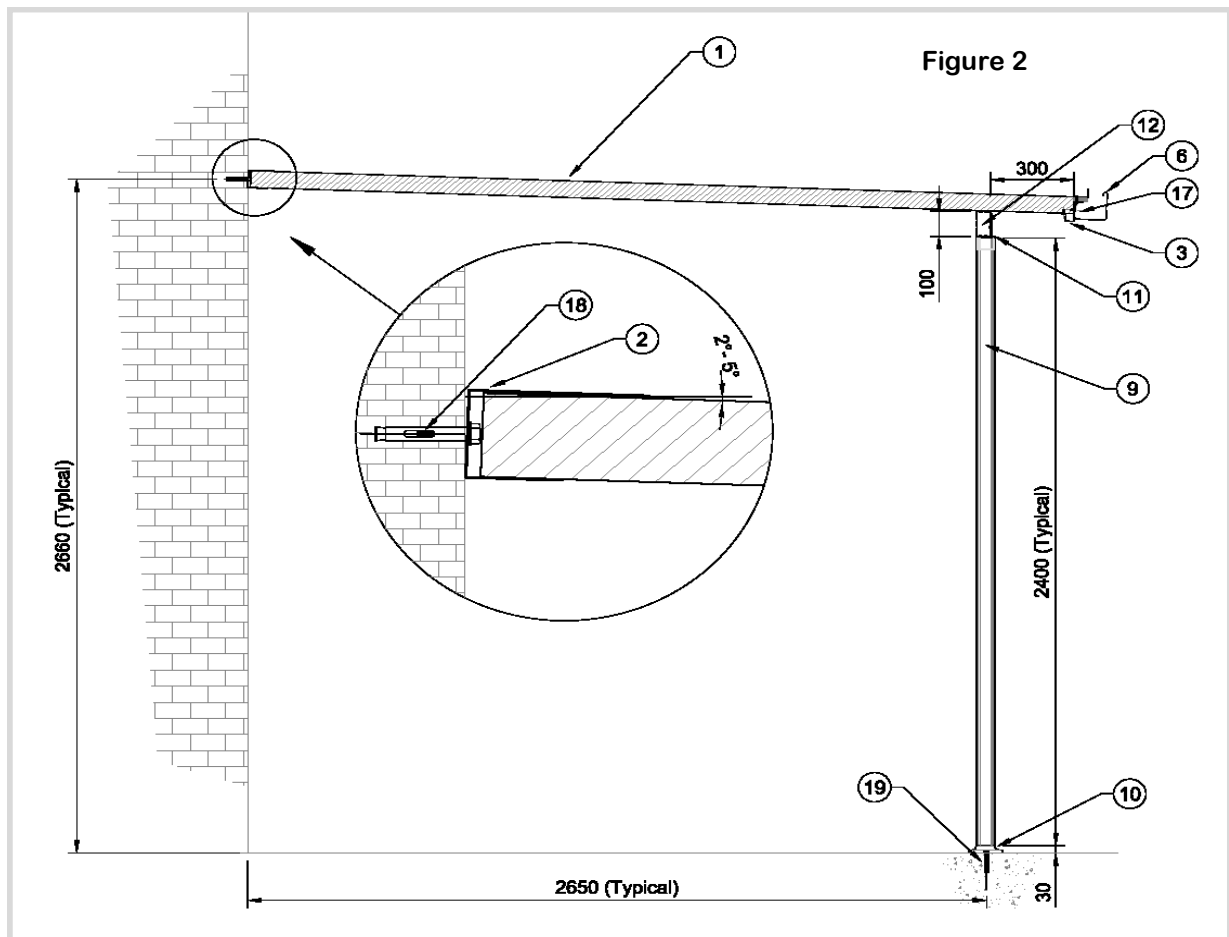

## ATTACHED ROOF

### 4.0 BEFORE YOU START

Please read these instructions carefully before starting any installation.

The parts description on page 2 identifies all the components supplied and shows where each component is located

### 5.0 LOCAL GOVERNMENT and BUILDER

It is important to check with your Local Government Authority (Council) prior to installation of the attached roof to confirm any building approvals that may be required and to confirm disposal of roof run off water

It is the Builders responsibility to ensure the existing structures are adequate to support the Insulspan attached roof. If required, the Builder must adequately reinforce existing structures to accommodate the additional building loads imposed by the Insulspan attached roof.

### 6.0 MARKING OUT THE RECEIVER CHANNEL/ATTACHED ROOF LOCATION

Mark out the location of the receiver channel and on the ground, mark out the overall area of the attached roof to ensure the location is free of any obstructions.

Ensure there will be no interference with existing door or window openings in the area where the attached roof will be located against the existing building

### 6.1 INSTALLATION OF THE RECEIVER CHANNEL

Before the receiver channel (item 2) is installed, inspect the wall area to ensure there are no obstructions, windows or door openings where the receiver channel will be located.

Ensure the height of the receiver channel on the wall does not exceed the available length of the posts.

Pre drill the receiver channel on the ground. Locate the end holes 50 mm from each end. Mark out the remaining holes in the channel at a maximum of 400 mm centres.

The drilled holes in the receiver channel may be used as a template for locating and drilling the holes in the wall.

Either by marking out the location of the holes in the wall or using the receiver channel as a template, drill the dynabolt holes in the wall. Ensure the receiver channel is located at the correct height on the wall and is level.

Before bolting the receiver channel to the wall, run a bead of silicone along the full length of the receiver channel near the top of the channel to ensure there are no gaps between the channel and the wall. Install the receiver channel using dynabolts (item 18).

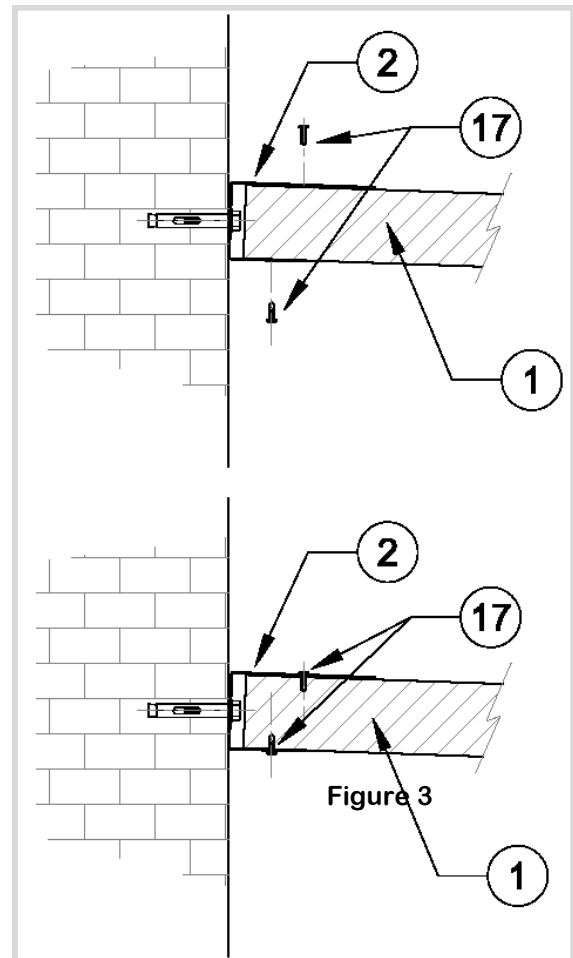

Figure 3 shows the assembly of the wall channel and the attached roof.

**7.0 POSTS / BEAM AND CONCRETE SLAB**

**7.1 FIXING POSTS TO EXISTING CONCRETE SLAB**

Before installing the post bases to the concrete slab, ensure the position of the post bases has been correctly measured.

The post bases (item 10) must be installed and bolted to the concrete slab before installing the posts (item 9)

Measure and mark the position of the post bases on the concrete slab.

Drill holes for the dynabolts (item 19) and bolt the post bases to the slab.

The posts are supplied in standard lengths and are normally cut to a shorter length to accommodate any variation in the slab height or the relative position of the receiver channel.

If required, cut the posts (item 9) to length.

Install the beam end caps (item 14) onto each end of the of the beam (item 12) using wafer head screws (item 17)

Install the post / beam connectors (item 11) into the beam (item 12) at the correct location and secure using wafer head screws (item 17)

Slide the posts (item 9) over the post / beam connectors (item 11) and secure using wafer head screws (item 17)

Lift the assembled beam and posts onto the post bases and temporarily brace the posts in the correct position.

Secure the posts (item 12) to the post bases (item 10) using wafer head screws (item 17)

The posts and receiver channel are now ready to install the roof panels

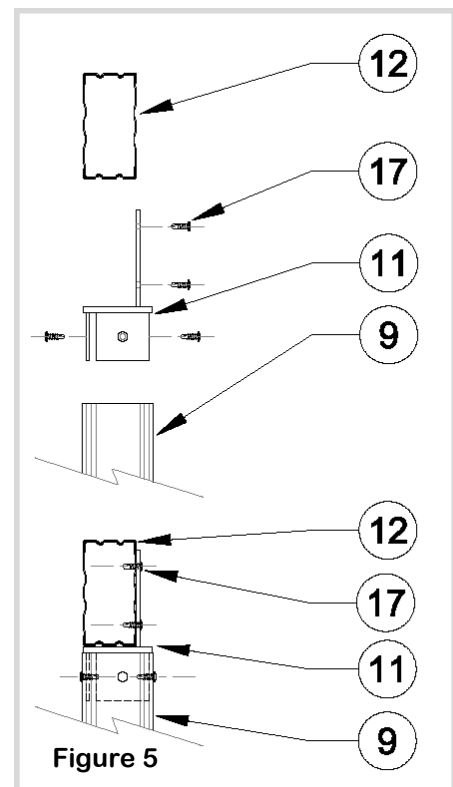
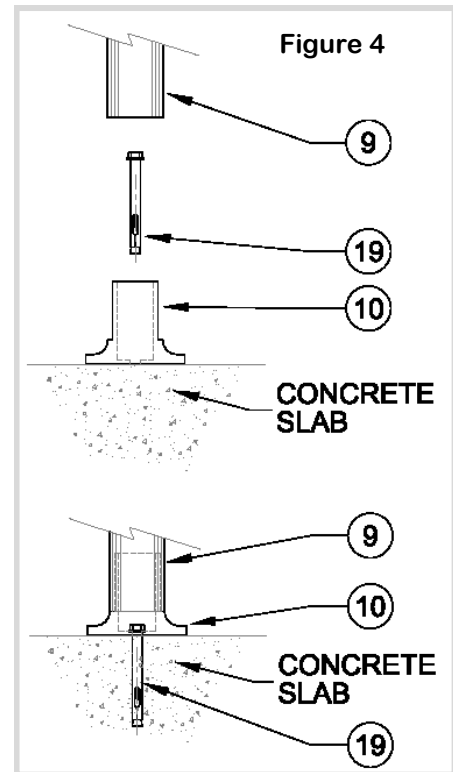

## 8.0 INSTALLING THE INSULSPAN ROOF PANELS

Each Insulspan roof consists of 4 separate roof panels which lock together to form a single roof having an overall length of 3050 mm and width of 2400 mm.

Before installing the first roof panel (item 1) into the receiver channel (item 2) the barge capping (item 5) must be fixed to the outside of that roof panel using wafer head screws (item 17).

Ensure the wafer head screws in the barge capping nearest the receiver channel, will not sit inside the receiver channel when the roof panel is assembled into the receiver channel.

Before installing the last roof panel into the receiver channel, the corrugated overlap on that panel must be removed (cut off) to allow installation of the barge capping at that end of the roof panel.

The separate roof panels are locked together as shown in Figure 7 with the corrugated overlap on one side of the panel overlapping the adjacent panel.

The direction of the corrugation overlap between the panels should be set to accommodate the prevailing weather direction.

The first roof panel (item 1) is installed by fixing one end of the panel into the receiver channel (item 2) and resting the other end of the roof panel on the beam (item 12). To secure the roof panel (item 1) into the receiver channel (item 2) use 2 wafer head screws (item 17) in the top of each roof panel and 2 wafer head screws (item 17) in the bottom of each roof panel (See Figure 3)

The second roof panel is then positioned against the first roof panel by sliding into the mating connection between the two panels as shown in Figure 7. This second panel is then secured to the receiver channel using wafer head screws (item 17). Take care not to damage the roof panel surface when sliding the panels together.

The process is repeated until the remaining roof panels are installed.

After all the roof panels are installed, secure the roof panels (item 1) to the beam (item 12) using screws (item 15) into each ridge of the roof panel.

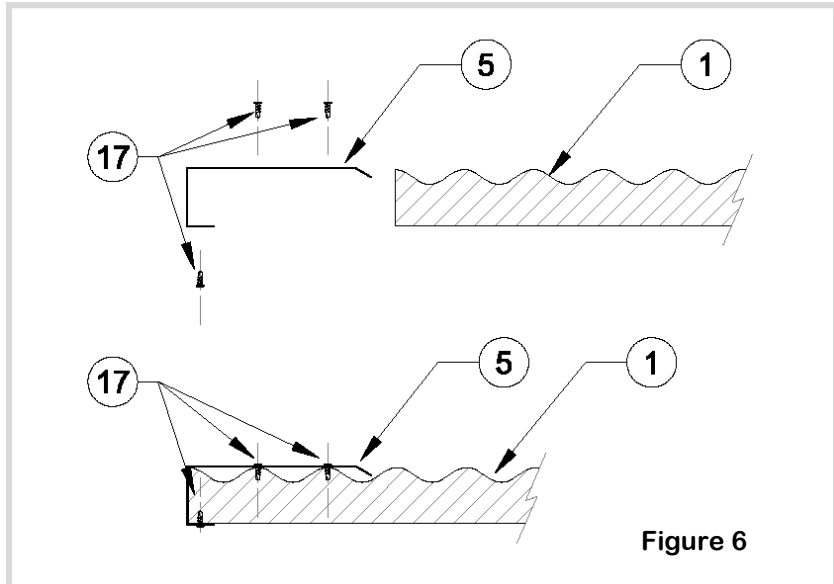

Figure 6

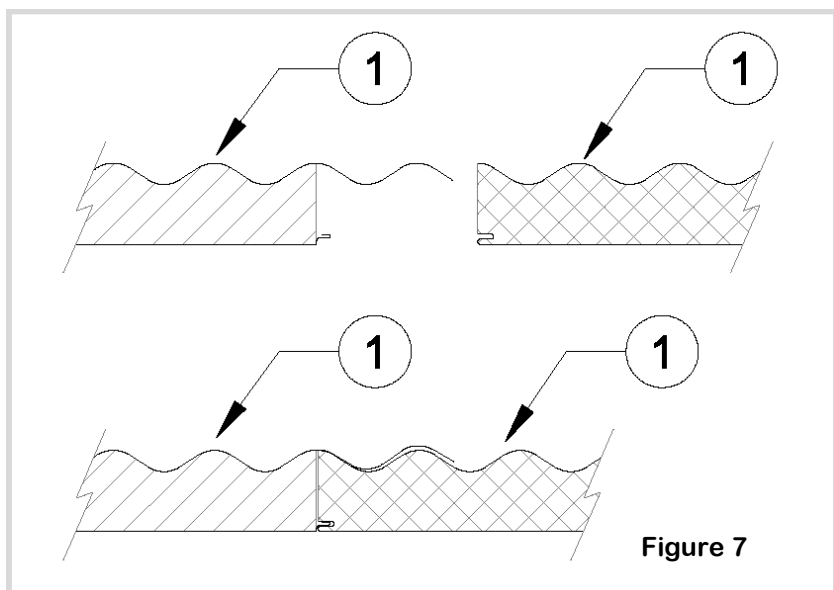

Figure 7



### 9.0 INSTALLING “Z” FLASHING AND GUTTER

After the roof panels have been fixed to the beam, install the “Z” flashing (item 3) using rivets (item 16) as shown in Figure 11

Install the “Z” flashing end caps (item 4) using rivets (item 16)

Install the gutter end caps (Item 7) using rivets (item 16)

Install the gutter brackets (item 8)

Install the gutter (item 6) using rivets (item 16)

When installing the gutter, secure the high end first and using a stringline, allow a minimum fall in the gutter of 1 in 500.

Use a neutral-cure silicone to seal the gutter.

