

ASSEMBLY INSTRUCTION FOR EXC-4J



Side Gables " BOTTOM SECTION " **A** & **E** = 1035 X 445 X 16
 Side Gables " TOP SECTION " **G** & **I** = 965 X 445 X 16

TOP, BOTTOM & MIDDLE FIXED SHELVES.

1 X TOP **H** = 575 X 443 X 16
 1 X MIDDLE **D** = 575 X 443 X 16
 1 X BOTTOM **C** = 575 X 443 X 16

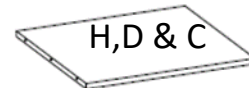

ADJUSTABLE SHELVES **K** - 2 X 575 X 443 X 16

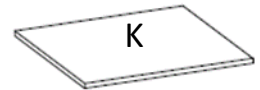









KICK BOARD **B** - 1 X 575 X 61 X 16



BACK PANELS - 1 X TOP **J** = 973 X 605 X 3mm
 1 X BOTTOM **F** = 963 X 605 X 3mm



PARTS IDENTIFICATION LIST

| NO | MODEL | DESCRIPTION | QTY | NO | MODEL | DESCRIPTION | QTY |
|----|---|-----------------------------|-----|----|--|----------------------|-----|
| 1 |  | CONFIRMAT SCREWS 50mm x 5mm | 20 | 5 |  | SUPPORT PINS | 8 |
| 2 |  | CAPS | 20 | 6 |  | 16mm PAN HEAD SCREWS | 1 |
| 3 |  | DOWELS | 4 | 7 |  | 25mm PAN HEAD SCREWS | 1 |
| 4 |  | BACKING NAILS | 75 | 8 |  | "L" SAFETY BRACKET | 1 |

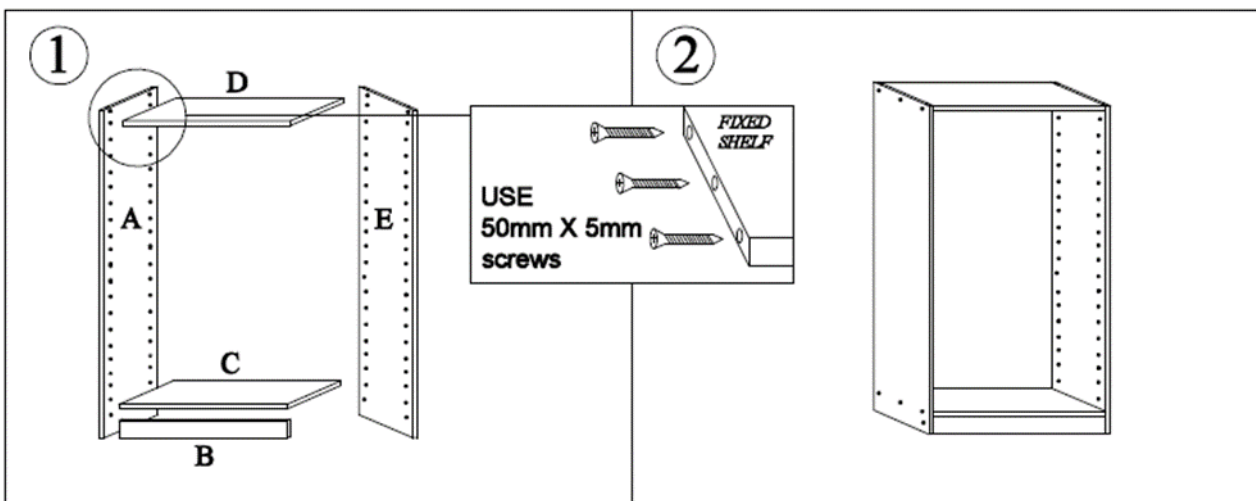

3

Fixing of the Backing Panel F 963 x 605

1. Place unit face down on the floor.

IMPORTANT

2. To ensure that the side gables A & E remain straight, start by placing the back panel F flush with the bottom of fixed shelf C keeping in the centre of side gables A & E nail (tack) at each side. Then keeping the back PARALLEL to the side gables nail (tack) the middle of each side, then the top, check measure the top middle and bottom are the same measurement, adjust if necessary! If ok, continue by placing nails approx 100mm apart.

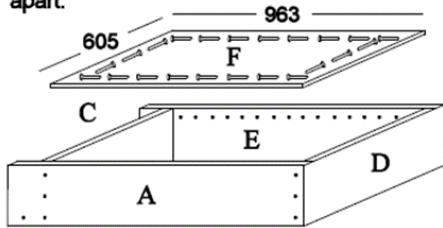

Back View

4

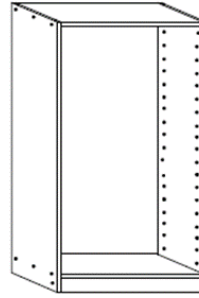

Bottom Section Complete

5

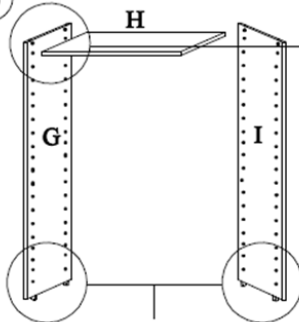

Insert the 4 X 8 mm wood dowels with wood glue.

6

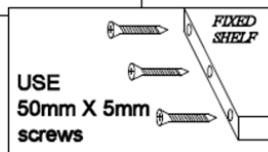

USE 50mm X 5mm screws

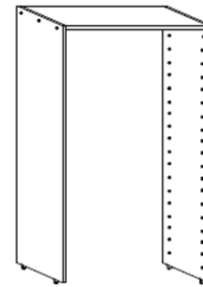

7

Fixing of the Backing Panel J 973 x 605

1. Place unit face down on the floor.

IMPORTANT

2. To ensure that the side gables G & I remain straight, start by placing the back panel J flush with the top of fixed shelf H keeping in the centre of side gables G & I nail (tack) at each side. Then keeping the back PARALLEL to the side gables nail (tack) the middle of each side, then the top, check measure the top middle and bottom are the same measurement, adjust if necessary! If ok, continue by placing nails approx 100mm apart.

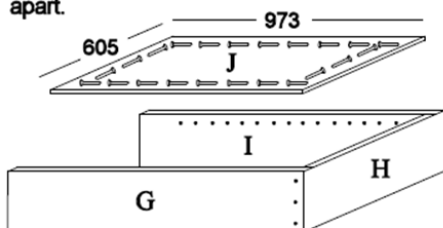

Back View

8

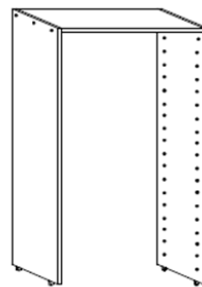

Top Section Complete

ASSEMBLY INSTRUCTIONS FOR EXECUTIVE SERIES (JOINING TOP & BOTTOM SECTIONS TOGETHER)

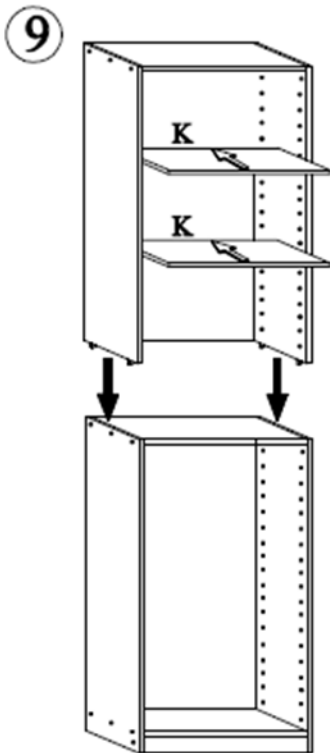

1. Place the top section over the bottom section aligning the 4 x dowels with the 8 mm holes, add some wood glue & push down firmly. Complete the nailing of the backs to shelf D. While standing in the upright position.

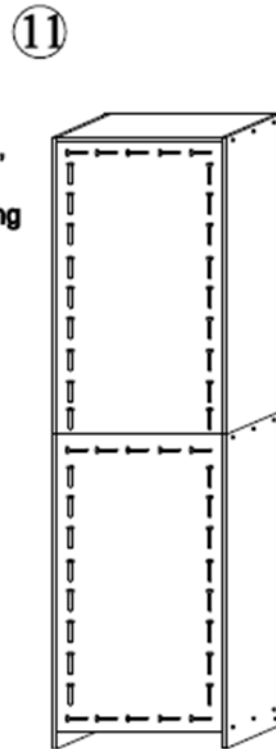

BACK VIEW

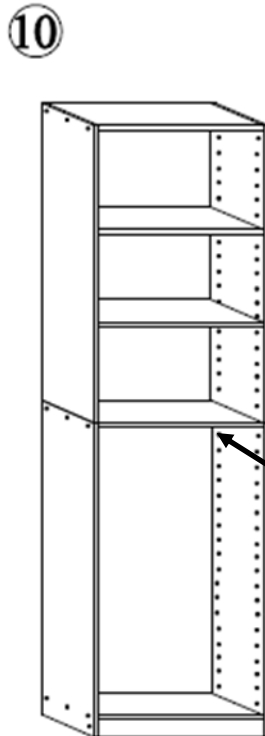

COMPLETED

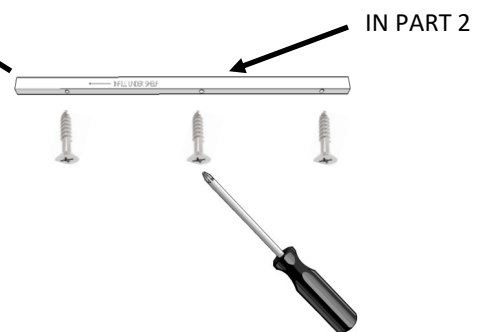

IMPORTANT
* FOR THE ASSEMBLY & PLACEMENT OF DRAWERS & BASKETS PLEASE REFER TO INSTRUCTIONS ENCLOSED IN THE CARTON MARKED- PART 2

WARNING: Serious injury or death can be caused by toppling furniture

Help prevent tip-over:

- Anchor this product to a wall or other suitable surface
- Check anchors regularly
- Avoid placing TVs on top unless the TV is also anchored
- Use drawer locks to prevent children climbing

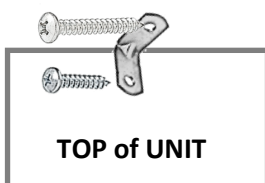

When attaching unit to wall put safety bracket in middle of unit with 16mm pan head screw then 25mm pan head screw into wall. For plasterboard without a stud it is recommended to use a plug with screw (not provided).

NEXT:- YOU WILL NEED TO RETRIEVE THE INFILL FROM PART 2, USING 3 X 30mm SCREWS PROVIDED, ATTACH THE INFILL TO THE UNDER-SIDE OF THE MIDDLE FIXED SHELF.

USING THE SHELF SUPPORTS  SUPPLIED YOU MAY PUT YOUR ADJUSTABLE SHELVES IN ANY POSITION.