

PARTS IDENTIFICATION LIST FOR MODEL LSS 550

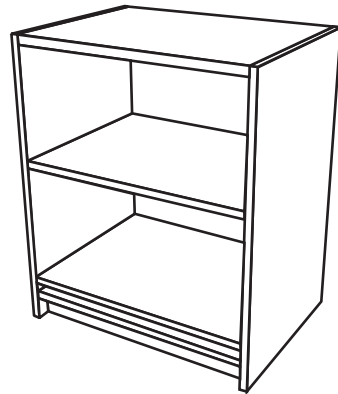

550mm H x 608mm W x 430mm D

2 x PANELS - 1 x LEFT HAND (A) , 1 x RIGHT HAND (E)

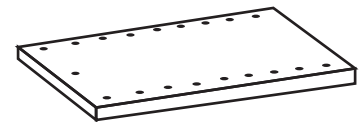

550mm H x 426mm W x 16mm D

TOP AND BOTTOM FIXED SHELF 1 x TOP (D) 1 x BOTTOM (C)

1 x KICK (B) 575mm x 61mm

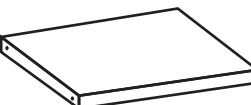

575mm H x 424mm W

2 x Pullout Shelves (G & H)

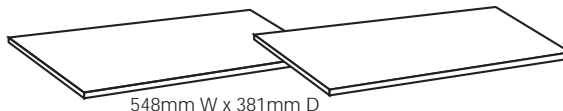





548mm W x 381mm D

1 x BACK PANEL (F) 488mm x 604mm

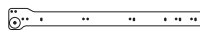

HARDWARE LIST

NO	MODEL	DESCRIPTIONS	QTY
1		M50 x 5mm CONFIRMAT SCREWS	10
2		WHITE CAPS	10
3		NAILS FIXING OF BACK	25
4		5/8 x 6 WOOD SCREWS FIXING SHELF RUNNER	8
5		EURO SCREW ATTACHMENT OF RUNNERS	8
6		SHELF RUNNERS	4

ASSEMBLY INSTRUCTIONS FOR MODEL LSS 550

STEP 1

Lay Panels A & E on the floor with the front vinyl edge facing you. Attach the metal cabinet runners to the 1st and 8th holes above the fixed shelf holes shown in diagram 1

It is important that the runners are fixed to the correct panels. Fix runners marked **CL** to the **LEFT PANEL (A)** and fix runners marked **CR** to the **RIGHT PANEL (E)** using the 7.5mm euro screws provided.

IMPORTANT: Please note diagram 2 shows the position of the holes that the metal runners are fixed into.

CABINET RUNNERS:

CL = Left Hand
CR = Right Hand

DIAGRAM 2



7.5mm Euro Screws to attach RUNNERS to Panels A & E

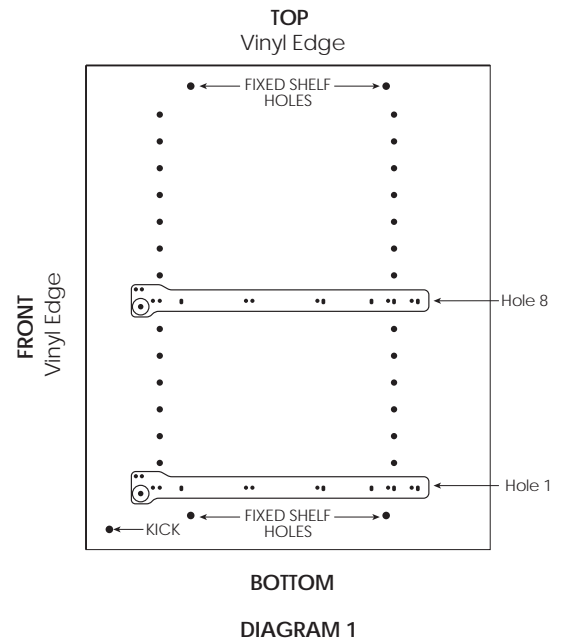

STEP 2

Align the fixed shelves (D) & (C) and Kick Board (B) to Left Panel (A) and Right Panel (E). Tighten using M50 x 5mm Confirmat Screws. Cover screws with White Caps

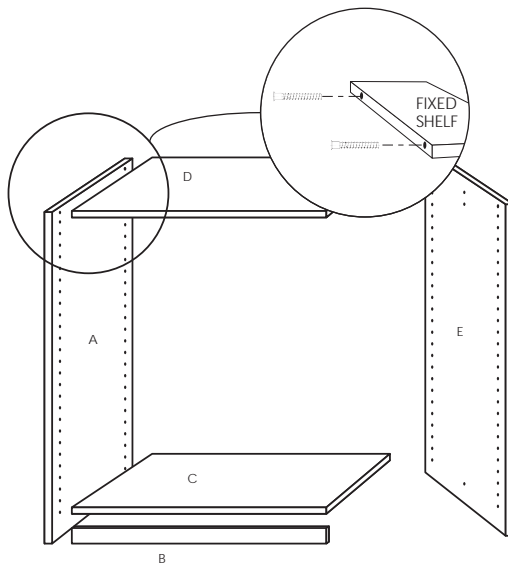

STEP 3

With the unit lying on its face, attached the Back Panel (F) making sure to keep it parallel to the Top and Sides of the unit. Attach using nails at regular intervals.

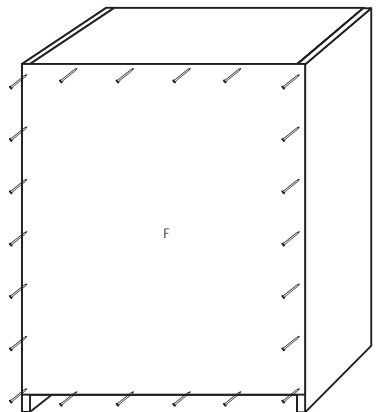

BACK VIEW

STEP 4

Attach Runners to Pullout Shelves (G) & (H) and slide into unit.

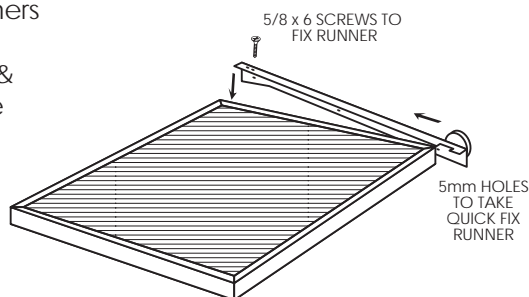

BACK OF PULLOUT SHELVES

STEP 5

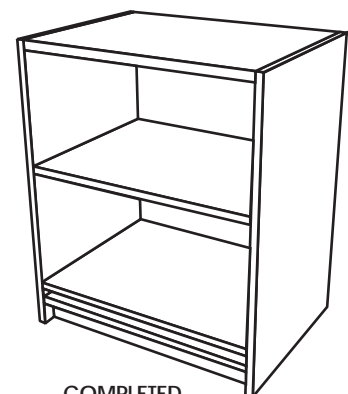

COMPLETED