



Manufacturer: ZHENGTE

Date: 2019-04-11

Version: 1

Specification 3X4M BRAMPTON CANTILEVER

Gale Pacific product code 491383

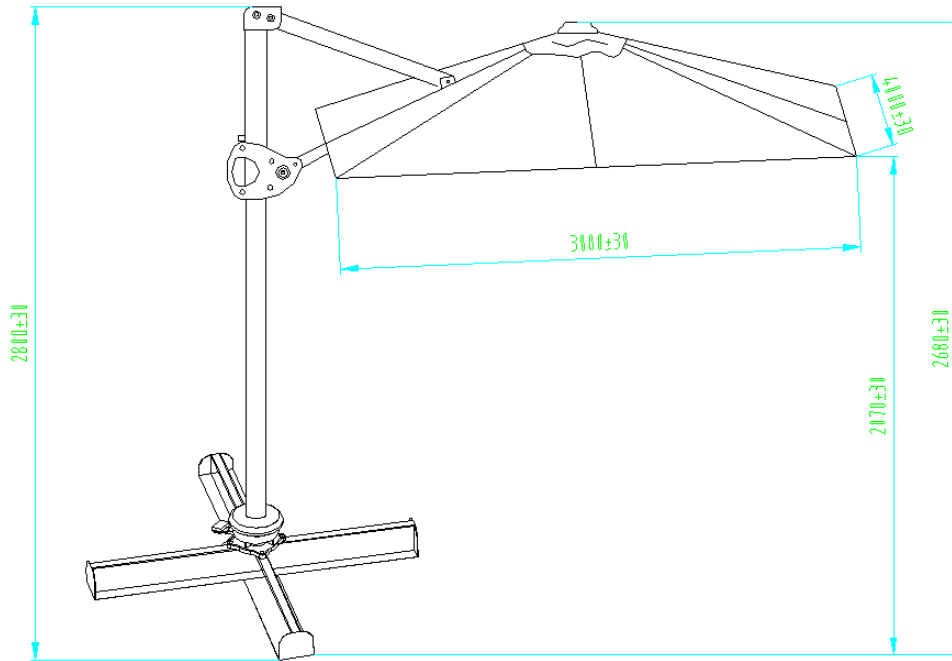

A. Frame Unit - schematic

Num	Part Name	Material	Qty	Size(mm)	Finished
1	Part A	Alu.+Steel+Polyester	1	/	Powder coating Charcoal
2	Part B	Q235(steel)	1	105x105x360	Powder coating Charcoal
3	Part C	Q235(steel)	1	1043x110x62x1.7	Powder coating Charcoal
4	Part D	Q235(steel)	1	1043x110x62x1.7	Powder coating Charcoal
5	Part E	YL104	1	/	Charcoal
6	Part F	Ocr18Ni9	4	M8x25	Zinc plating
7	Part G	Ocr18Ni9	4	M8x30	Zinc plating
8	Part H	ABS	1	Ø172xØ120x38	Charcoal
9	Part I	Q235	1	M8	/
10	Part J	Q235/PA	1	/	Charcoal
11	Part K	ABS+Ocr18Ni9	1	/	Charcoal
12	rope	Bulletproof fiber	1	Ø3.8x3800	/
13	fabric	polyester	1	3000x4000	PU coating













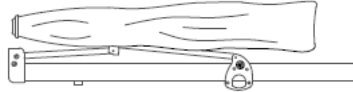

Manufacturer: ZHENGTE

Date: 2019-04-11

Version: 1

Specification 3X4M BRAMPTON CANTILEVER

Gale Pacific product code 491383

REF	NB	
A	1	
B	1	
C	1	
D	1	
E	1	
F	4	M8*25  
G	4	M8*30  
H	1	
I	1	
J	1	
K	1	