

ozito

HIGH PRESSURE CLEANER

1300W 1450 PSI

INSTRUCTION MANUAL

SPECIFICATIONS

Input:	220–240V ~ 50Hz
Motor:	1300W
Rated Flow:	5.7 l/min
Max. Flow:	6.8 l/min
Permissible Pressure:	10 MPa (1450 psi)
Rated Pressure:	7 MPa (1015 psi)
Inlet Water Pressure:	0.6 MPa (87 psi) max.
Water Supply Temp.:	40°C max.
IP Rating:	IPX5
Weight:	4.3kg

ozito.com.au

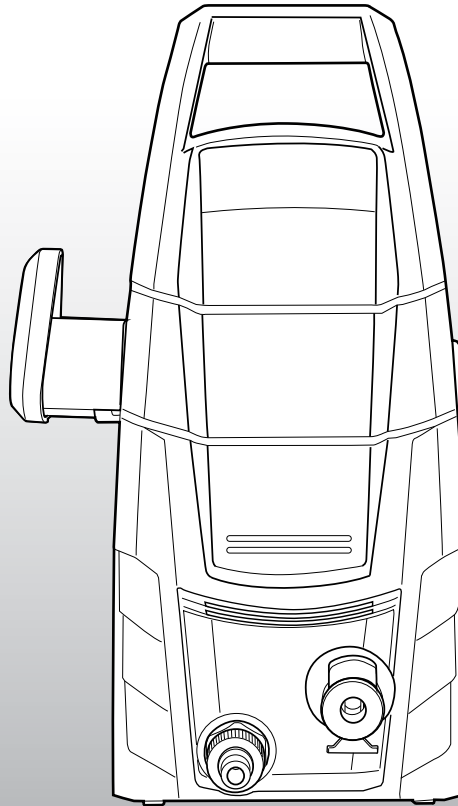

WHAT'S IN THE BOX



High Pressure Cleaner

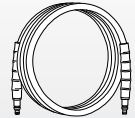

3m High Pressure Hose

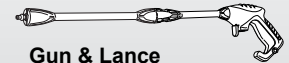

Gun & Lance



Deck & Patio Cleaner



Adjustable Spray Nozzle,
Detergent Spray Bottle

3 YEAR REPLACEMENT WARRANTY

PWE-1300

ELECTRICAL SAFETY

 **WARNING!** When using mains-powered tools, basic safety precautions, including the following, should always be followed to reduce risk of fire, electric shock, personal injury and material damage.

Read the whole manual carefully and make sure you know how to switch the tool off in an emergency, before operating the tool.

Save these instructions and other documents supplied with this tool for future reference.

The electric motor has been designed for 230V and 240V only. Always check that the power supply corresponds to the voltage on the rating plate.



This tool is double insulated therefore no earth wire is required

Note: The supply of 230V and 240V on Ozito tools are interchangeable for Australia and New Zealand.

If operating a power tool in a damp location is unavoidable use a residual current device (RCD) protected supply. Use of an RCD reduces the risk of electric shock.

Using an Extension Lead

Always use an approved extension lead suitable for the power input of this tool. Before use, inspect the extension lead for signs of damage, wear and ageing. Replace the extension lead if damaged or defective.

When using an extension lead on a reel, always unwind the lead completely. Use of an extension lead not suitable for the power input of the tool or which is damaged or defective may result in a risk of fire and electric shock.

GENERAL POWER TOOL SAFETY WARNINGS - PERSONAL SAFETY

 **WARNING!** Read all safety warnings and all instructions. Failure to follow the warnings and instructions may result in electric shock, fire and/or serious injury. Save all warnings and instructions for future reference. The term "power tool" in the warnings refers to your mains-operated (corded) power tool or battery-operated (cordless) power tool.

1. Work area safety

- Keep work area clean and well lit.** Cluttered or dark areas invite accidents.
- Do not operate power tools in explosive atmospheres, such as in the presence of flammable liquids, gases or dust.** Power tools create sparks which may ignite the dust or fumes.
- Keep children and bystanders away while operating a power tool.** Distractions can cause you to lose control.

2. Electrical safety

- Power tool plugs must match the outlet. Never modify the plug in any way. Do not use any adapter plugs with earthed (grounded) power tools.** Unmodified plugs and matching outlets will reduce risk of electric shock.
- Avoid body contact with earthed or grounded surfaces, such as pipes, radiators, ranges and refrigerators.** There is an increased risk of electric shock if your body is earthed or grounded.
- Do not expose power tools to rain or wet conditions.** Water entering a power tool will increase the risk of electric shock.
- Do not abuse the cord. Never use the cord for carrying, pulling or unplugging the power tool. Keep cord away from heat, oil, sharp edges or moving parts.** Damaged or entangled cords increase the risk of electric shock.
- When operating a power tool outdoors, use an extension cord suitable for outdoor use.** Use of a cord suitable for outdoor use reduces the risk of electric shock.
- If operating a power tool in a damp location is unavoidable, use a residual current device (RCD) protected supply.** Use of an RCD reduces the risk of electric shock.

3. Personal safety

- Stay alert, watch what you are doing and use common sense when operating a power tool. Do not use a power tool while you are tired or under the influence of drugs, alcohol or medication.**
A moment of inattention while operating power tools may result in serious personal injury.
- Use personal protective equipment. Always wear eye protection.** Protective equipment such as dust mask, non-skid safety shoes, hard hat, or hearing protection used for appropriate conditions will reduce personal injuries.
- Prevent unintentional starting. Ensure the switch is in the off-position before connecting to power source and/or battery pack, picking up or carrying the tool.** Carrying power

tools with your finger on the switch or energising power tools that have the switch on invites accidents.

- Remove any adjusting key or wrench before turning the power tool on.**
A wrench or a key left attached to a rotating part of the power tool may result in personal injury.
 - Do not overreach. Keep proper footing and balance at all times.** This enables better control of the power tool in unexpected situations.
 - Dress properly. Do not wear loose clothing or jewellery. Keep your hair, clothing and gloves away from moving parts.** Loose clothes, jewellery or long hair can be caught in moving parts.
 - If devices are provided for the connection of dust extraction and collection facilities, ensure these are connected and properly used.** Use of dust collection can reduce dust-related hazards.
- ## 4. Power tool use and care
- Do not force the power tool. Use the correct power tool for your application.** The correct power tool will do the job better and safer at the rate for which it was designed.
 - Do not use the power tool if the switch does not turn it on and off.** Any power tool that cannot be controlled with the switch is dangerous and must be repaired.
 - Disconnect the plug from the power source and/or the battery pack from the power tool before making any adjustments, changing accessories, or storing power tools.** Such preventive safety measures reduce the risk of starting the power tool accidentally.
 - Store idle power tools out of the reach of children and do not allow persons unfamiliar with the power tool or these instructions to operate the power tool.** Power tools are dangerous in the hands of untrained users.
 - Maintain power tools. Check for misalignment or binding of moving parts, breakage of parts and any other condition that may affect the power tool's operation. If damaged, have the power tool repaired before use.** Many accidents are caused by poorly maintained power tools.
 - Keep cutting tools sharp and clean.** Properly maintained cutting tools with sharp cutting edges are less likely to bind and are easier to control.
 - Use the power tool, accessories and tool bits etc. in accordance with these instructions, taking into account the working conditions and the work to be performed.** Use of the power tool for operations different from those intended could result in a hazardous situation.
- ## 5. Service
- Have your power tool serviced by a qualified repair person using only identical replacement parts.** This will ensure that the safety of the power tool is maintained.
 - If the supply cord is damaged, it must be replaced by the manufacturer, its service agent or similarly qualified persons in order to avoid a hazard.**

HIGH PRESSURE CLEANER SAFETY WARNINGS

RISK OF UNSAFE OPERATION

What can happen

- Unsafe operation of your high pressure cleaner could lead to serious injury or death to you or others.
- The spray gun/wand is a powerful cleaning tool that could look like a toy to a child.
- Reactive force of spray results in gun/lance movement, potentially causing the operator to slip, fall or misdirect the spray. Improper control of gun/wand can result in injuries to self, others and property damage.

How to prevent it

- Become familiar with the operation and controls of the pressure cleaner.
- Keep children away from the pressure cleaner at all times.
- Never modify or remove the safety features of this product.
- Do not operate the machine with missing, broken or unauthorized parts.
- Never leave wand unattended while unit is running.
- Keep work area free of obstacles.
- Stand on stable surface and grip gun/lance firmly. Expect the gun to kick back when engaged

1) Do not use to pump flammable or explosive liquids such as gasoline, fuel oil, kerosene, solvents or thinners. Pump should only be used with liquids compatible with water blaster component materials. Failure to follow to this warning can result in serious personal injury, death and/or property damage.

2) Water high presser cleaner must be located on a solid level surface. Pump could tip or fall causing serious injury.

3) Do not hold or suspend pump by means of a discharge pipe. Pipe could break or come loose.

WARNING! This appliance has been designed for use with the cleaning agent supplied or recommended by the manufacturer. The use of other cleaning agents or chemicals may adversely affect the safety of the appliance.

WARNING! Do not use the appliance within range of persons unless they wear protective clothing.

WARNING! High pressure jets can be dangerous if subject to misuse. The jet must not be directed at persons, live electrical equipment or the appliance itself.

- Do not direct the jet against yourself or others in order to clean clothes or foot-wear.
- To ensure appliance safety, use only original spare parts from the manufacturer or approved by the manufacturer.

WARNING! High pressure hoses, fittings and couplings are important for the safety of the appliance. Use only hoses, fittings and couplings recommended by the manufacturer.

- Do not use the appliance if a supply cord or important parts of the appliance are damaged, e.g. safety devices, high pressure hoses, trigger gun.

This machine is not intended for use by persons (including children) with reduced physical, sensory or mental capabilities, or lack of experience and knowledge.

WARNING! Water that has flowed through backflow preventer is considered to be non-potable.

KNOW YOUR PRODUCT

HIGH PRESSURE CLEANER

- | | |
|---------------------------------|-------------------------|
| 1. Accessory holder | 4. Quick connect system |
| 2. Water inlet connector | 5. On/Off switch |
| 3. High pressure hose connector | 6. Carry handle |

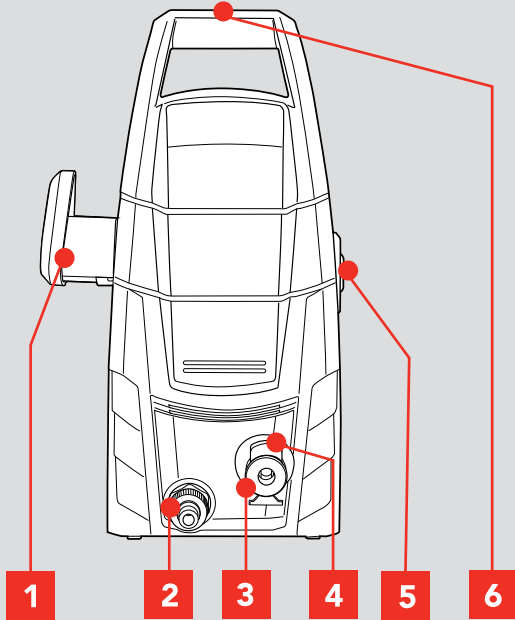

ACCESSORIES

- | | |
|-------------------------|-----------------------------|
| 7. Deck & patio cleaner | 11. High pressure hose |
| 8. Rotor arm | 12. Screws & U-clip |
| 9. Lance | 13. Adjustable spray nozzle |
| 10. Gun | 14. Detergent spray bottle |

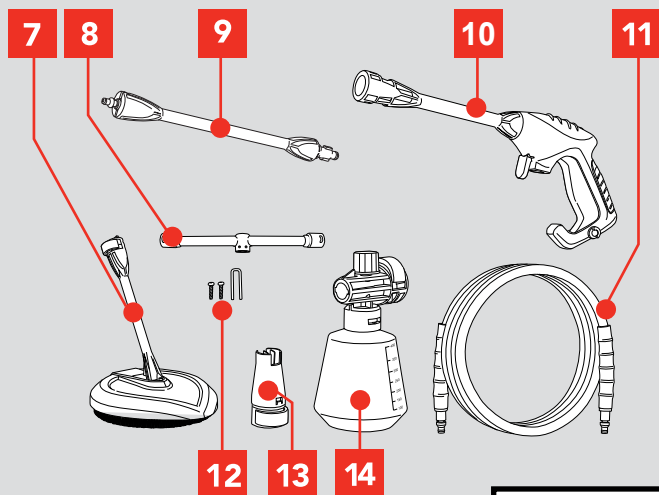

ONLINE MANUAL

Scan this QR Code with your mobile device to take you to the online manual.

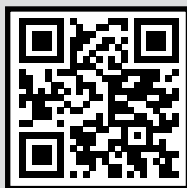

SETUP & PREPARATION

1. ASSEMBLY



WARNING! ENSURE THE TOOL IS SWITCHED OFF AND DISCONNECTED FROM THE POWER SUPPLY BEFORE PERFORMING ANY OF THE FOLLOWING PROCEDURES.

Fitting the accessory holder

1. Push accessory holder onto the high pressure cleaner.

The holder can be used for storage of the gun, lance and high pressure hose.

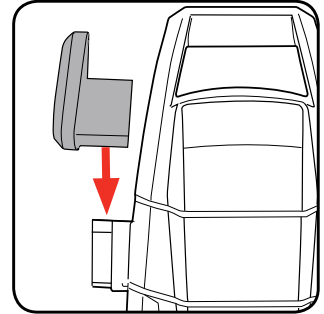

Deck & patio cleaner

1. Attach the extension onto the deck & patio cleaner.

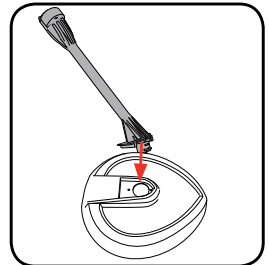

2. Fasten from the underside using the 2 screws provided

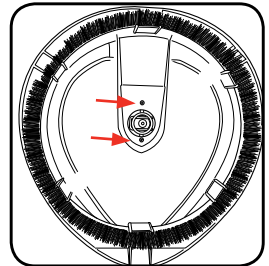

3. Attach the rotor arm to the deck & patio cleaner and secure by inserting the U-clip.

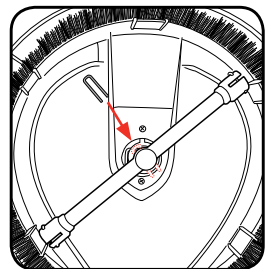

3

 YEAR REPLACEMENT WARRANTY

2. CONNECTIONS

Gun and lance

1. Fasten the lance to the gun by pushing and twisting.

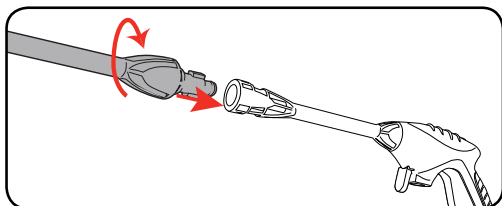

Quick connect system

The connections of the accessories are attached with a quick connection system.

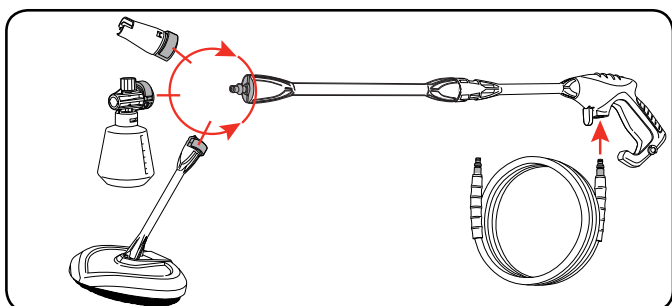

1. To Connect, push the accessory onto the lance connection.

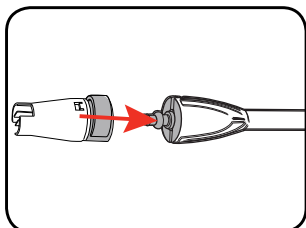

2. To remove, actuate the quick connection system and remove the accessory

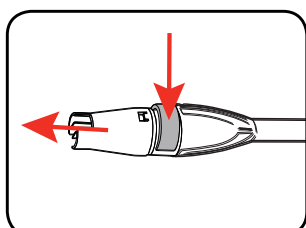

High pressure hose

1. Connect the high pressure hose to the gun.
2. Connect the opposite end of the high pressure hose to the high pressure cleaner

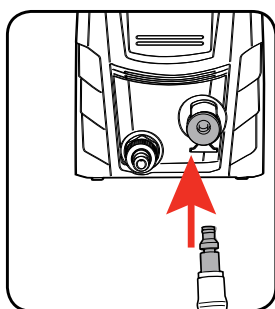
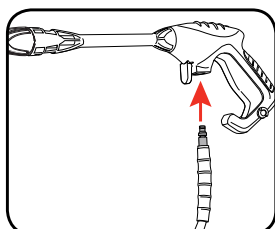

Water supply

For use only with mains pressure water when a backflow preventer is installed on the inlet of the pressure washer. For further information contact Ozito Customer Service.

1. Run water through your garden hose to remove any foreign matter before attaching to the pump

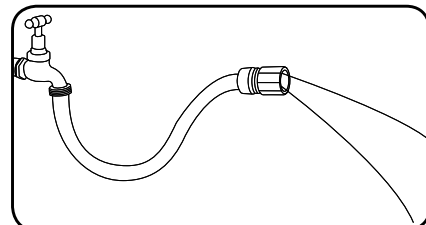

2. Attach garden hose (min. Ø 1/2") to the water inlet connector on the pump. Always use a reinforced hose with a standard coupling for water inlet. The hose should be at least 6m in length for proper operation.

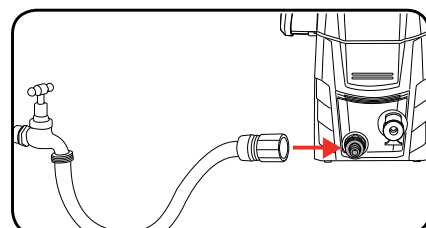

Note: A filter is fitted to the inlet connector preventing any debris from entering the pump. Inspect and clean the filter before use as insufficient water supply could damage the pump.

OPERATION

3. OPERATION

On/Off switch

CAUTION! THIS PRODUCT MUST BE USED WITH A RESIDUAL CURRENT DEVICE RATED 30mA OR LESS.

- To switch the machine On, set the On/Off switch to position "I" (On)

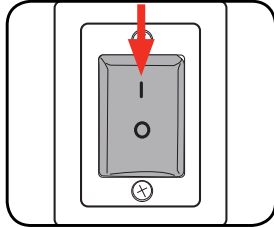

- To switch the machine Off, move the On/Off switch to position "0" (Off).

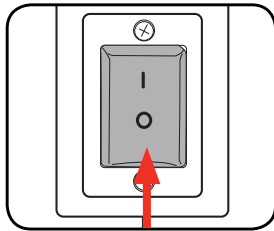

Spray gun

The trigger can be locked to prevent accidental spraying. Disengage trigger lock before squeezing trigger.

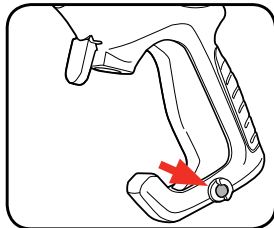

Adjustable spray nozzle

The shape of the water jet can be adjusted from solid cone or flat fan by turning the nozzle.

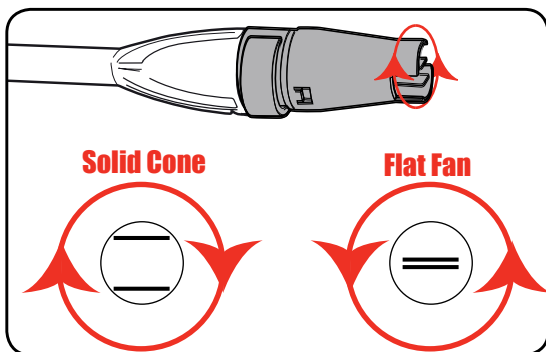

Detergent spray bottle

Fill the detergent spray bottle with suitable cleaning agent.

Note: Use only cleaning agents which are expressly suitable for high pressure cleaners.

The quantity of cleaning agent you want can be adjusted by turning (+ / -) on the setting dial. The cleaning agent will be dispersed automatically.

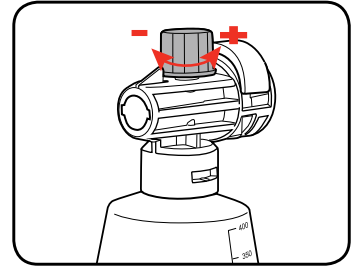

4. PRE-START PROCEDURE

1. Ensure power supply is connected.

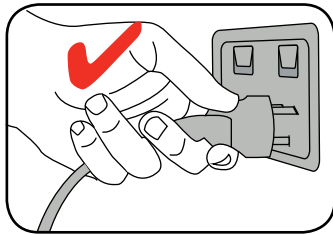

2. Ensure water supply is connected.

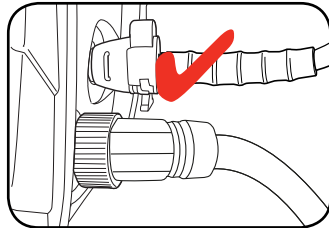

3. Ensure water supply is turned on.

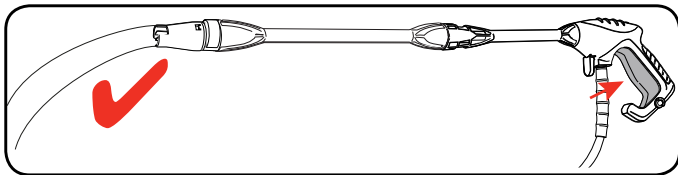
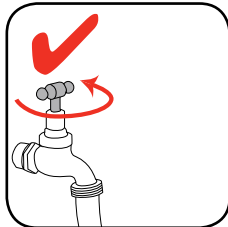

4. Squeeze trigger on the gun until there is a steady flow of water from the nozzle.

5. SPRAYING

1. Switch the machine On, set the On/Off switch to position "I" (On)

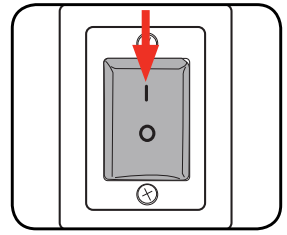

2. Squeeze trigger to begin spraying.

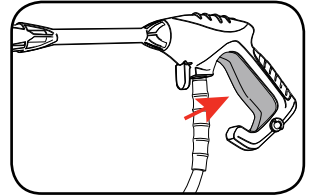

3. When finished, set On/Off switch to position "0" (Off).

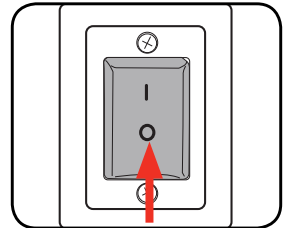

4. Release built up water pressure by squeezing the trigger.

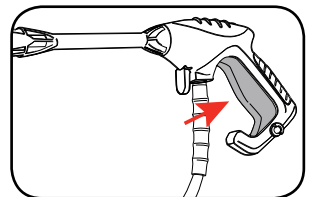

5. Turn water supply off.

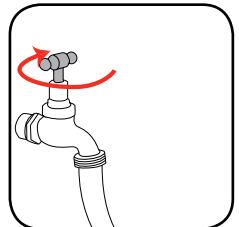

6. Switch off the mains power supply and remove the electrical plug.

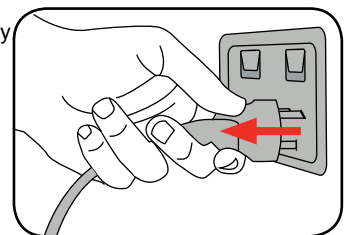

MAINTENANCE

6. TROUBLE SHOOTING

Problem	Cause	Solution
The high pressure cleaner does not start	1. No power supply	1. Check the power supply, the power plug and the socket-outlet.
	2. Insufficient supply power	2. Make sure that the extension cable is not too long.
	3. Outside temperature is too low	3. Never operate with an outside temperature of below 5°C.
	4. Motor is overheated	4. Allow the motor to cool down. If necessary, remedy the cause of the overheating.
The motor starts but there is no pressure build-up	1. Water intake filter is clogged	1. Clean the water intake filter
	2. Air intake in the water inlet	2. Check the supply hose and hose connectors and replace if necessary
	3. Water tap closed	3. Turn open the water tap
The operating pressure is irregular	1. Air intake in the water inlet	1. Check the supply hose and hose connectors and replace if necessary

7. CLEANING & MAINTENANCE

IMPORTANT! BEFORE CLEANING YOUR HIGH PRESSURE CLEANER OR CARRYING OUT ANY MAINTENANCE PROCEDURE, MAKE SURE THAT THE MOTOR IS OFF AND THE TOOL DISCONNECTED FROM THE POWER SUPPLY TO PREVENT ACCIDENTAL STARTING.

IMPORTANT! WAIT UNTIL THE HIGH PRESSURE CLEANER HAS COMPLETELY COOLED DOWN. RISK OF BURNS!

Cleaning

- Keep the safety devices free of dirt and dust as far as possible. Wipe the equipment with a clean cloth or blow it with compressed air at low pressure.
- We recommend that you clean the appliance immediately after you use it.
- Clean the appliance regularly with a damp cloth and some soft soap. Do not use cleaning agents or solvents; these may be aggressive to the plastic parts in the appliance. Ensure that no water can get into the interior of the appliance.
- You must disconnect the hose and any spraying tools from the compressor before cleaning. Do not clean the compressor with water, solvents or the like.

Testing the water intake filter



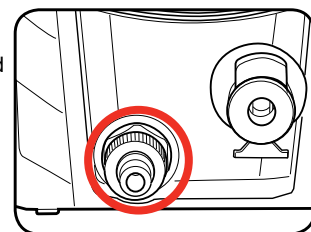



Periodically check the intake filter in order to prevent clogging, which could jeopardize operation of the pump. To do this, unscrew the connector for the water inlet hose from the high pressure cleaner and clean the exposed inlet sieve under running water.



8. STORAGE

The high pressure cleaner should be fully emptied of water each time after use. This requires you to switch on the equipment without a connected water supply and to squeeze trigger on the gun (max. 1 minute) until no more water emerges. Then you must switch off the equipment.

DESCRIPTION OF SYMBOLS

V	Volts	Hz	Hertz
~	Alternating current	W	Watts
/min	Revolutions or reciprocation per minute	Hp	Horse power
l/min	Litres per minute	dB	Decibel level
psi	Pounds per square inch	BAR	Pressure rating
	Read instruction manual		Warning
IPX5	Ingress protection from water		Regulator compliance mark
	Double insulated	MPa	Megapascal
	Sound power level		
	Warning! High pressure jets can be dangerous if not used properly. Do not direct the jet at persons, animals, live electrical equipment or the pressure washer itself.		
	This machine is not suitable for connecting to the drinking water network unless a backflow preventer is installed on the inlet of the pressure washer.		

CARING FOR THE ENVIRONMENT

 Power tools that are no longer usable should not be disposed of with household waste but in an environmentally friendly way. Please recycle where facilities exist. Check with your local council authority for recycling advice.

 Recycling packaging reduces the need for landfill and raw materials. Reuse of recycled material decreases pollution in the environment. Please recycle packaging where facilities exist. Check with your local council authority for recycling advice.

SPARE PARTS

Spare parts can be ordered from the Special Orders Desk at your local Bunnings Warehouse.

For further information, or any parts not listed here, visit www.ozito.com.au or contact Ozito Customer Service:

Australia 1800 069 486

New Zealand 0508 069 486

E-mail: enquires@ozito.com.au

WARRANTY

IN ORDER TO MAKE A CLAIM UNDER THIS WARRANTY YOU MUST RETURN THE PRODUCT TO YOUR NEAREST BUNNINGS WAREHOUSE WITH YOUR BUNNINGS REGISTER RECEIPT. PRIOR TO RETURNING YOUR PRODUCT FOR WARRANTY PLEASE TELEPHONE OUR CUSTOMER SERVICE HELPLINE:

Australia 1800 069 486

New Zealand 0508 069 486

TO ENSURE A SPEEDY RESPONSE PLEASE HAVE THE MODEL NUMBER AND DATE OF PURCHASE AVAILABLE. A CUSTOMER SERVICE REPRESENTATIVE WILL TAKE YOUR CALL AND ANSWER ANY QUESTIONS YOU MAY HAVE RELATING TO THE WARRANTY POLICY OR PROCEDURE.

The benefits provided under this warranty are in addition to other rights and remedies which are available to you at law.

Our goods come with guarantees that cannot be excluded at law. You are entitled to a replacement or refund for a major failure and for compensation for any other reasonably foreseeable loss or damage. You are also entitled to have the goods repaired or replaced if the goods fail to be of acceptable quality and the failure does not amount to a major failure.

Generally you will be responsible for all costs associated with a claim under this warranty, however, where you have suffered any additional direct loss as a result of a defective product you may be able to claim such expenses by contacting our customer service helpline above.

3 YEAR REPLACEMENT WARRANTY

Your product is guaranteed for a period of **36 months from the original date of purchase**. If a product is defective it will be replaced in accordance with the terms of this warranty. Warranty excludes consumable parts, for example: bearings, o-rings.

WARNING

The following actions will result in the warranty being void.

- If the tool has been operated on a supply voltage other than that specified on the tool.
- If the tool shows signs of damage or defects caused by or resulting from abuse, accidents or alterations.
- Failure to perform maintenance as set out within the instruction manual.
- If the tool is disassembled or tampered with in any way.
- Professional, industrial or high frequency use.