

Scandia Heating (Aust) Pty Ltd
306 South Gippsland Highway
Dandenong South VIC 3175
Australia

+61 3 5792 2388

info@scandiaheating.com.au

www.scandiaheating.com.au



2017 RANGE & ACCESSORIES BROCHURE



Take This Brochure to the Special Orders Desk to place an order



Styliste' 6 (Item no: 3171534) with optional woodbox (Product Code: SCSTYWB6).

As nature's original heat source and the world's first oven, fire still has the power to stir our most primal instincts, bringing people together to relax, engage and share our most intimate moments.

At Scandia, we know how to tame fire and we are experts in designing wood fires and stoves that thrive in Australian conditions. Our world class designs and commitment to quality are inspired by Scandinavian cultural values and the craftsmanship for which they are renowned. These same values resonate throughout our organisation, instilling a passion for designing great quality, affordable wood fires.

In the harsh winters of Scandinavia, fire is essential for survival and this is also true for many Australians who rely on fire as the primary source of heating. In Australia fire is also about socialising, about bringing the outdoors in and allowing us to get back to nature. It keeps the gathering going outside as night falls when the chill in the air would send us back indoors.

At Scandia, we believe in the power of fire to bring people together. We believe in the power of Scandia to bring quality design and Australians together.



PRECISION ENGINEERING
Scandia utilises CNC laser technology and robotics to manufacture products of impeccable quality, engineered to precise specification.

TRADITIONAL RANGE

With origins forged in Australian history, the classical styling and design of our traditional range represents the pinnacle in affordable, high quality wood heating.

- Minimum 10 year firebox warranty
- Crafted Japanese fireproof glass
- Firebrick lined fireboxes
- "Clearview" glass air wash system
- High temperature stove paint



Item no: 3170754

Heat & Cook is exempt from testing under AS/NZS 4012 and 4013

HEAT & COOK

Whether it's wood fired pizza on the deck or the primary source of heating, cooking or hot water, this wood fired oven is as diverse as it is functional. Featuring cast iron doors and an extra large cooktop, the Heat & Cook is the perfect addition to any indoor or outdoor living space.

- Heat up to 200m²
- Large baker's oven
- Optional hot water jacket
- 650w x 565d x 865h



Item no: 3171288

WARMBRITE 140

Perfect for the cottage home, holiday house or man cave, the Warmbrite 140 is an affordable, radiant wood fire. The radiant construction method also means that the top panel of the firebox operates as a highly effective cooktop for soups, stews and pot roasts.

- Heat up to 140m²
- 5mm heavy duty firebox
- 500w x 450d x 735h

63% Efficiency 1.5g/kg Emissions 15.6kW kW Rating



Item no: 3171489

WARMBRITE 200

This traditionally styled, medium sized, fan forced convection wood fire is engineered to effectively heat small to medium sized homes. The Warmbrite 200 is also ideal for environments where space is limited.

- Heat up to 200m²
- Maximised overnight burn times
- 3 speed electric fan
- 673w x 530d x 735h

67% Efficiency 1.1g/kg Emissions 7.9kW kW Rating



Item no: 3171485

WARMBRITE 300

This traditionally styled, large format convection wood fire is perfect for use in large, open plan homes and commercial environments where ambience is paramount.

- Heat up to 300m²
- Maximised overnight burn times
- 3 speed electric fan
- 770w x 580d x 810h

62% Efficiency 1.3g/kg Emissions 10.1kW kW Rating



For more information about the Scandia Warmbrite Range, scan the QR code to watch a short video or visit our website www.scandiastoves.com.au.

200 STACKER

This is a modern and practical adaptation of our most popular wood fire, the Warmbrite 200, with the addition of a handy wood storage pedestal designed to keep firewood dry and conveniently located.

- 🏠 Heat up to 200m²
- 🔥 Large wood storage
- ⚙️ 3 speed electric fan
- 📏 673w x 530d x 865h

67% Efficiency 1.1g/kg Emissions 7.9kW kW Rating



Item no: 3171483

300 STACKER

The Stacker 300 combines a large wood storage pedestal with the body of our classical Warmbrite 300 to create a practical and powerful wood fire combination perfect for large open plan spaces.

- 🏠 Heat up to 300m²
- 🔥 Large wood storage
- ⚙️ 3 speed electric fan
- 📏 770w x 580d x 910h

62% Efficiency 1.3g/kg Emissions 10.1kW kW Rating



Item no: 3171535



Item no: 3171219



Item no: 3171224

SUPREMACY 200

This premium, mid size, slow combustion wood fire is engineered to deliver a unique combination of elegance, refinement, technology, sustainability and industry leading performance.

- 🏠 Heat up to 200m²
- 🔥 8mm heavy duty steel firebox
- ⚙️ Soft touch fan control with infrared remote
- 📏 655w x 575d x 725h

67% Efficiency 1.1g/kg Emissions 10.2kW kW Rating

SUPREMACY 300

The largest model in our premium range, the Supremacy 300 has presence in any room with its sleek lines and bay window design. This powerful, yet elegant unit is capable of heating large, open plan homes and commercial spaces.

- 🏠 Heat up to 300m²
- 🔥 8mm heavy duty steel firebox
- ⚙️ Soft touch fan control with infrared remote
- 📏 755w x 662d x 765h

69% Efficiency 0.9g/kg Emissions 13.9kW kW Rating



For more information about the Scandia Supremacy Range, scan the QR code to watch a short video or visit our website www.scandiastoves.com.au.



Warmbrite 200i-S3 (Item no: 3171223) Depicted with optional fascia (Item no: 3171258).

WARMBRITE 200i-S3*

The 200i-S3 combines contemporary styling with heritage inspired design to deliver a mid sized, inbuilt fire perfect for zero clearance, mid mount and masonry fireplace installations.

- Heat up to 180m²
- Zero clearance option
- To suit mid or floor mount install
- 923w x 695h
- 1013w x 719h
- 696w x 457d x 562h

61%	0.4g/kg	9.0kW
Efficiency	Emissions	kW Rating



Item no: 3171221

WARMBRITE 300i-S3*

The Warmbrite 300i-S3 combines sleek and elegant design with powerful and efficient heating capability. This stylish convection wood fire will comfortably heat most large homes.

- Heat up to 280m²
- Zero clearance option
- To suit mid or floor mount install
- 1015w x 735h
- 1113w x 759h
- 795w x 503d x 604h

61%	0.9g/kg	9.5kW
Efficiency	Emissions	kW Rating

WHY CHOOSE AN INBUILT WOOD FIRE?

Everyone loves an open fire, but in reality they are inefficient, plagued by excessive fuel consumption and uncontrollable heat levels that send much of the energy produced straight up the chimney as carbon emissions. Scandia's Series 3 range of inbuilt wood fires are an ideal solution for home owners with existing open fires and who are seeking a cleaner, warmer, more sustainable wood fire. They are also ideal for the new home builder/renovator wanting the warmth, ambience and style of an inbuilt wood fire without the need for a masonry fireplace.



For more information about zero clearance, scan the QR code to watch a short video or visit our website www.scandiastoves.com.au.

*The Warmbrite inbuilt range is supplied with a mid mount fascia. The floor mount fascia option can be ordered separately at any Bunnings Special Orders desk.

CONTEMPORARY RANGE

Influenced by a passion for combining indoor and outdoor living and the unmistakable elegance and style of European design, the team at Scandia has created a visionary range of radiant and open wood fires perfect for the most inspired indoor/outdoor living spaces.

- Minimum 10 year firebox warranty
- Tested and approved to AS/NZS 4012/4013 and 2918 safety standards
- Heavy duty steel construction
- Firebox liners to maximise burn efficiency

HELIX GRAPHITE

A Scandinavian inspired design with elegant contours, subtle grey tones and concentric lines, the Helix Graphite is the perfect centrepiece for any contemporary home. This powerful radiant heater delivers the ambience and warmth you can get only from an Australian designed wood fire.

- Heat up to 200m²
- Practical wood storage
- Extended overnight burn times
- 615w x 450d x 1160h

62%	1.5g/kg	7.0kW
Efficiency	Emissions	kW Rating



Item no: 3171506

EDGE 50

Evolving from French provincial origins, the Edge's clean lines and delicate legs convey style and elegance. Expansive glass panels encase a radiant firebox, and the large top is great for cooking winter soups and stews. The Edge is a stylish wood fire designed to deliver an ethereal ambience to any indoor/outdoor living space.

- Heat up to 200m²
- Optional wood storage pedestal
- Panoramic fire views with glass on three sides
- 620w x 480d x 775h

62% Efficiency 1.3g/kg Emissions 6.4kW kW Rating



Item no: 3171487

EDGE 70

- Heat up to 320m²
- Optional wood storage pedestal
- Panoramic fire views with glass on three sides
- 710w x 600d x 970h

60% Efficiency 0.5g/kg Emissions 11.4kW kW Rating



Edge 70 Stacker. Item no: 3171267
Edge 50 Stacker. Product Code: SPE50ST



Item no: 3171226



Avante (Item no: 3171225) depicted with supplied black fascia, corten and stainless steel fascias are optional.



Optional corten fascia (Item no: 3171265)



Optional stainless steel fascia (Item no: 3171266)



Included stainless steel cooking plate

AVANTE

Engineered for indoor and outdoor spaces the Avante open fireplace is as adaptable as it is stylish; uninterrupted fire views are beautifully framed by a range of four fascia options, making it the ideal centrepiece for any entertaining area.

Included with every Avante is an adjustable, stainless steel cooking plate which converts this opulent fireplace into a wood fired BBQ in a matter of seconds.

- Indoor/outdoor open fire
- Zero clearance option
- 5.5mm stainless steel cooking plate
- Removable safety screen included
- 1294w x 577d x 770h

VERDANT LE PELLET FIRE

Verdant LE utilises environmentally sustainable, carbon neutral bio mass pellet fuel to provide the warmth and ambience of a traditional wood fire without the need to cut, split and store firewood.

- Renewable fuel source
- Overall average efficiency 79%
- Thermostatic control (7 Day Programming)
- Very low emissions 0.8g/kg
- 510w x 440d x 960h

79% Efficiency 0.8g/kg Emissions 6.9kW kW Rating



Item no: 3171530

STYLISTE' RANGE

The epitome of style and elegance Styliste by Scandia takes the essence of traditional radiant wood fire design and elevates it to entirely new level. The beautifully crafted Styliste' 6 and Styliste' 10 boast clean lines, expansive fire views and unparalleled performance for emissions and efficiency.

STYLISTE' 6

The beautifully crafted Styliste' 6's inspired lineal stance embodies the essence of minimalist design placing all emphasis on the enchanting flame pattern as it heats homes up to 22 squares whilst achieving unparalleled performance on emissions and efficiency.

- Heats up to 200m²
- 5 Freestanding designs
- 2 Inbuilt designs
- Create your own personal design

63% Efficiency 1.4g/kg Emissions 7.7kW kW Rating



Styliste' 6. Item no: 3171534. Optional Struktur Modular Box 5, Box 6 and Plinth. (SCSTYMB5, SCSTYMB6, SCSTYP6)



Default - Leg Set: SCSTYLEG



Woodbox 6: SCSTYWB6



Pedestal 6: SCSTYPD6



Styliste' 6 floor mount fascia: SCSTYFM6



Styliste' 6 mid mount fascia: SCSTYMM6



Plinth 10: SCSTYP10

DIMENSIONS

Styliste' 6 Firebox

640w x 525d x 500h

Styliste' 6 Inbuilt

726w x 534h

726w x 579h

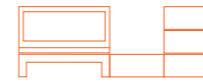

STRUKTUR

For the ultimate in wood fire design solutions combine your Styliste' wood fire with our Struktur elements to create a truly personal statement customised by you and tailored to your own individual space.



Styliste' 10. Item no: 3171533. Optional Struktur Modular Box 5, Box 6 (SCSTYMB5, SCSTYMB6)



Default - Leg Set: SCSTYLEG



Woodbox 10: SCSTYWB10



Pedestal 10: SCSTYPD10



Styliste' 10 floor mount fascia: SCSTYFM10



Styliste' 10 mid mount fascia: SCSTYMM10



Plinth 16: SCSTYP16

STYLISTE' 10

The beautifully crafted Styliste' 10 engages you with its clean lines, expansive firebox and a captivating flame pattern that mesmerises with its radiant ambience. Styliste' 10 provides almost limitless configuration and installation solutions using elements from the Struktur range. The Styliste' 10 effectively and efficiently heats homes up to 33 squares.

- Heat up to 300m²
- 5 Freestanding designs
- 2 Inbuilt designs
- Create your own personal design

60% Efficiency 1.1g/kg Emissions 11.5kW kW Rating

DIMENSIONS

Styliste' 10 Firebox

1060w x 525d x 500h

Styliste' 10 Inbuilt

1146w x 534h

1146w x 584h

STYLISTE' & STRUKTUR ELEMENTS DESIGNED BY YOU

STRUKTUR

Combine the modular elements of Struktur with select products in the Styliste' or Edge range of wood fires to create an inspired wood fire experience, designed exclusively by you to suit your home.

LIMITLESS SCALE, LIMITLESS DESIGN..

Offering 7 individual installations options for each model, Styliste' has a personality to suit every home. Each model provides the choice of five freestanding or two inbuilt configurations.

Simply select the Styliste' design that best reflects your own personal taste.

For the ultimate in wood fire design solutions combine your Styliste' wood fire with our Struktur elements to create a truly personal statement, customised by you and tailored to your own individual space.

STYLISTE' 6

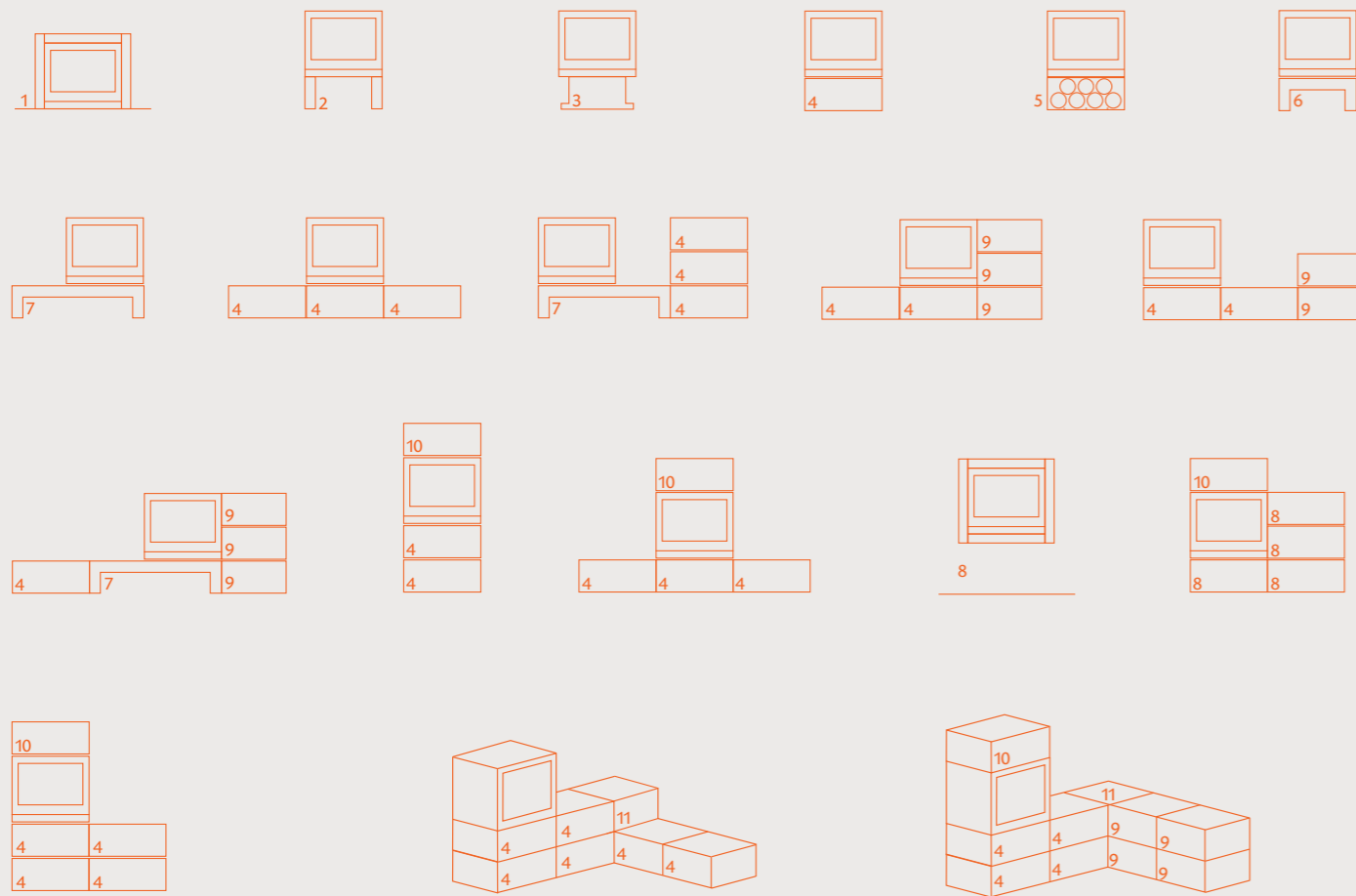

STYLISTE' 10

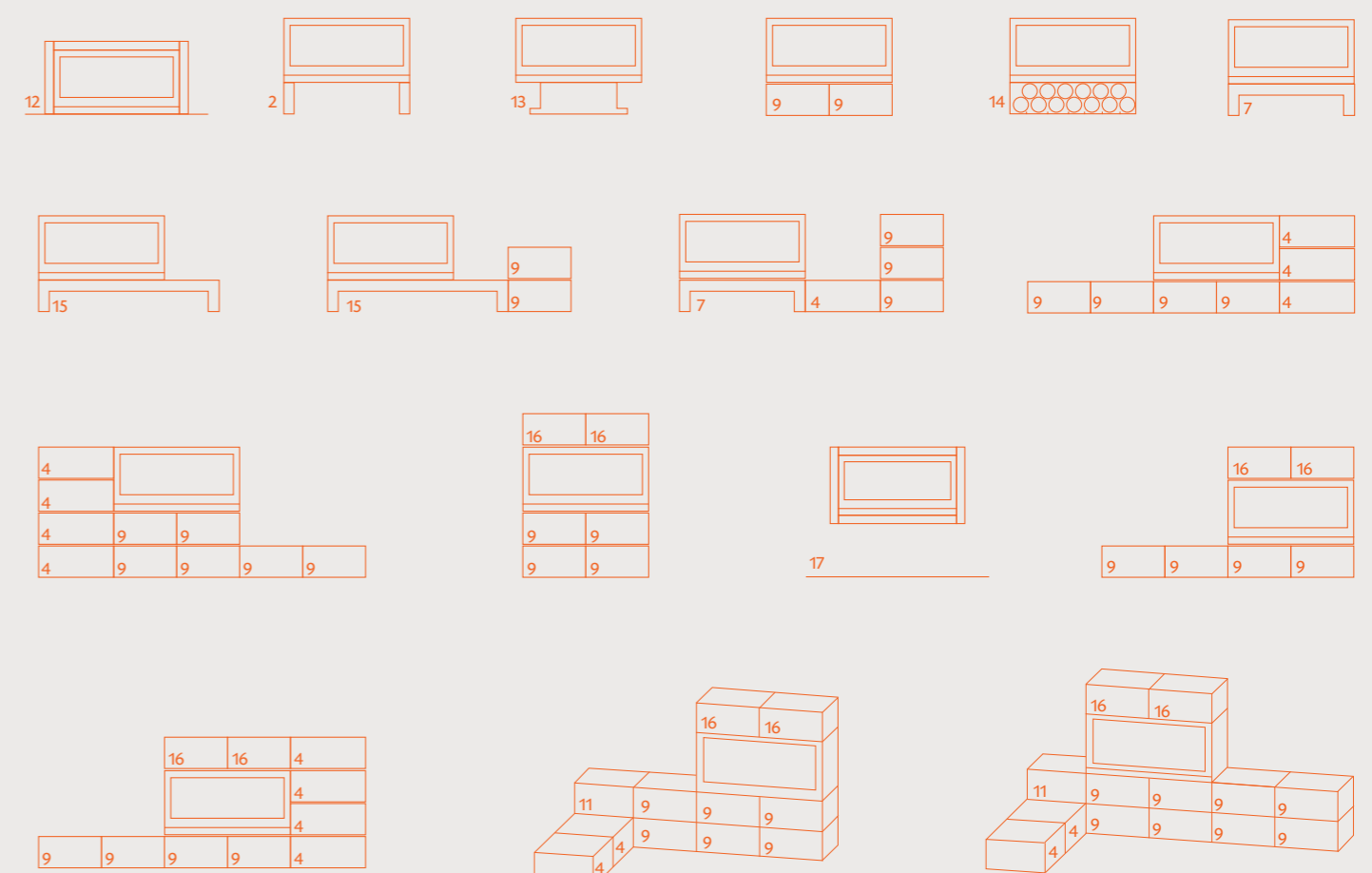

SPECIAL ORDER

	DESCRIPTION	PRODUCT CODE	QTY
1	Styliste' 6 Floor Mount Fascia	SCSTYFM6	
2	Styliste' Freestanding Legs (Default)	SCSTYLEG	
3	Styliste' 6 Freestanding Pedestal	SCSTYPD6	
4	Struktur Module Box 6	SCSTYMB6	
5	Styliste' 6 Freestanding Woodbox	SCSTYWB6	
6	Styliste' Freestanding Plinth 6	SCSTYP6	
7	Styliste' Freestanding Plinth 10	SCSTYP10	
8	Styliste' 6 Mid Mount Fascia	SCSTYMM6	
9	Struktur Module Box 5	SCSTYMB5	

	DESCRIPTION	PRODUCT CODE	QTY
10	Struktur Top Box 6	SCSTYTB6	
11	Struktur Corner Box	SCSTYCB	
12	Styliste' 10 Floor Mount Fascia	SCSTYFM10	
13	Styliste' 10 Freestanding Pedestal	SCSTYPD10	
14	Styliste' 10 Freestanding Woodbox	SCSTYWB10	
15	Styliste' Freestanding Plinth 16	SCSTYP16	
16	Struktur Top Box 5 Kit	SCSTYTB5	
17	Styliste' 10 Mid Mount Fascia	SCSTYMM10	

GAS LOG FIRES

AVEDUR

Avedur's lineal design and elegant styling encases a sweeping ribbon of flame that dances across high gloss vitreous panels designed to enhance the appearance of the natural flame whilst minimising operating costs and consumption of our precious gas resources.

The focal point of any living space Avedur boasts an impressive list of standard features that include:

- 4 decorative media options
- 7 adjustable flame height
- Zero clearance design
- Built in primary mesh guard
- Dual multi speed fans
- LPG conversion kit

 Thermostatic control (7 day programming)

 4 decorative fascia options

 High gloss reflective panels

 Optional wifi app

 1235w x 20d x 610h

79% Efficiency 4.0 Star Rating 5.6kW kW Rating



Avedur Item no: 3171490. Image depicts optional Black Glass Fascia. Item no: SCAV10BG

Efficiency and power results are based on highest rating for certain flue configurations



Default - Black Fascia. Product code: SCAV10BLK. Included with purchase of Avedur 3171490



Stainless Fascia Avedur Product Code: SCAV10SST



Black & Stainless Fascia Avedur - Product Code: SCAV10SSB

ALTERNATIVE FASCIA OPTIONS

Select from four decorative fascia and four decorative media options to create a personalised fireplace that best represents the ambience and effect you want to achieve.



Included: Driftwood & Embers. SCAV10M1

ALTERNATIVE FLAME MEDIA



Driftwood & Glass. Product code: SCAV10M2



Stone Accent & Embers. Product code: SCAV10M3



Stone Accent & Glass. Product code: SCAV10M4



REMOTE CONTROL

- Built in thermostat
- 7 day programming
- 7 flame heights adjustment

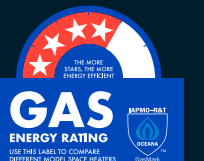

WOOD STORAGE



Beehive 850 Coreten Wood Storage. Item: 3171647

BEEHIVE 500 WOOD STORAGE

Used individually or collectively the Beehive range by Scandia is available in two sizes and styles, the 500mm black metallic beehive is ideal for indoor living spaces and our large 850mm coreten steel version is deep enough to stack two rows of firewood and is the perfect addition to any inspired outdoor living space.

- Easy to assemble
- Stackable
- Powder coated finish
- Quality steel construction



Beehive 500 Metallic Black Wood Storage. Item: 3171648



Designer Rectangle Wood Storage 1000. Item: 3171657



Designer Rectangle Wood Storage 1500. Item: 3171658



Geometric Cantilever Wood Storage. Item: 3171653



750 Round Wood Storage. Item: 3171650
Removable stand for wall mount option.



Angled Wall Storage. Item: 3171659



Curved Cantilever Wood Storage. Item: 3171652



Coreten 1000 Round Wood Storage. Item: 3171651



U- Stack Wood Storage. Item: 3171655



Designer Vertical Wood Storage 1800. Item: 3171656

FIREWOOD STORAGE

The Scandia wood storage range represents quality, functionality and inspired design. This range of products has been developed with the same ethos we use when developing any product that we sell. It must be affordable, on the cutting edge of design, be robust and fit for purpose.

When it came to wood storage this simply meant that everything we produce has to look great, provide indoor and outdoor application and be strong enough to hold decent quantities of Australian hardwood...We think we've nailed it.

FIRETOOL RANGE



Gun Metal Firetool Set. Item no: 3171608



Classic Firetool Set. Item no: 3180727



Deluxe Firetool Set. Item no: 3180728



Vogue Firetool Set. Item no: 3171607



Contour Firetool Set. Item no: 3171610



Alpine Firetool & Wood Storage Set. Item no: 3171609

HEARTHIS



Item no: 3171526

CERAMIC TILE HEARTH - CORNER INSTALL

This modern, black, ceramic tile hearth pad is made from durable, non-combustible materials, is easy to install and available in two sizes; suitable for all wood heater brands.

- Steel angle frame on all sides
- Available in two sizes (mm):
1250 x 1250 Item no: 3171526
1425 x 1425 Item no: 3171527



Item no: 3171524



Item no: 3171621

CERAMIC TILE HEARTH - STRAIGHT WALL

This modern, black, ceramic tile hearth pad is made from durable, non-combustible materials, is easy to install and available in three sizes; suitable for all wood heater brands.

- Steel angle frame on all sides
- Available in three sizes (mm):
1050 x 1050 Item no: 3171524
1050 x 1200 Item no: 3171522
1200 x 1200 Item no: 3171525

OAK GREY HEARTH - STRAIGHT INSTALL

These contemporary wood effect tile hearth pads are the perfect platform for a modern heater that deserves more than just black. Our hearth pads are constructed from durable, non-combustible materials, are easy to install. Suitable for all wood heater brands.

- Decorative aluminium edge
- Available in two sizes (mm):
1050 x 1200 Item no: 3171621
1050 x 1050 Product Code: SCHPW105105



Item no: 3180687



Item no: 3180690

SLATE HEARTH - STRAIGHT WALL

This traditional, slate hearth pad is made from durable, non-combustible materials, is easy to install and available in three sizes; suitable for all wood heater brands.

- Decorative aluminium edge
- Available in three sizes (mm):
1050 x 1050 Item no: 3180687
1050 x 1200 Item no: 3180688
1200 x 1200 Item no: 3180689

SLATE HEARTH - CORNER INSTALL

This traditional, slate hearth pad is made from durable, non-combustible materials, is easy to install and available in two sizes; suitable for all wood heater brands.

- Decorative aluminium edge
- Available in two sizes (mm):
1250 x 1250 Item no: 3180690
1425 x 1425 Item no: 3180691

ACCESSORIES

Scandia offer a complete range of wood storage, fire tools, hearth pads, heater guards, spare parts and installation accessories for most brands of wood heaters sold in Australia.

If you can't find what you are looking for instore visit scandiastoves.com.au for a complete range of available items. Items not found instore can be ordered at any Bunnings Special Orders desk.

BLACK MESH DEFAULT 4M FLUE KIT

Designed and tested to suit all Scandia freestanding wood fires, the powder coated, black mesh decorative flue looks great on any of the traditional wood fire range.

- Triple skin flue
- 304 SST active flue
- 304 SST cowl and cone
- Powder coated finish

SLEEK BLACK DEFAULT 4M FLUE KIT

Designed and tested to suit all Scandia freestanding wood fires, the powder coated, sleek black decorative flue looks great on any of the contemporary wood fire range.

- Triple skin flue
- 304 SST active flue
- 304 SST cowl and cone
- Powder coated finish

6" INBUILT 4M FLUE KIT

Designed and tested to suit the Warmbrite 200i and 300i, this flue kit is for use in an existing masonry chimney. Zero clearance flue kits are also available – ask instore or visit the website for details.

- Suits masonry installation
- 304 SST active flue
- 304 SST cowl and cone
- Chimney cover plate

GRAPHITE FLUE KIT

Designed and tested to suit all Scandia freestanding wood fires, the powder coated, graphite decorative flue has been designed to match perfectly with the Helix Graphite wood fire.

- Triple skin flue
- 304 SST active flue
- 304 SST cowl and cone
- Powder coated finish

BLACK MESH INTERNAL BEND KIT

Designed and tested to suit all Scandia freestanding wood fires, the powder coated, black mesh decorative flue looks great on any of the traditional wood fire range.

- 304 SST active flue
- Powder coated finish

SLEEK BLACK INTERNAL BEND KIT

Designed and tested to suit all Scandia freestanding wood fires, the powder coated, sleek black decorative flue looks great on any of the contemporary wood fire range.

- 304 SST active flue
- Powder coated finish

6" EXTENDABLE FLUE BRUSH

Clean your flue safely from ground level up to 5m with the Scandia flexible flue brush kit. Pull through and rooftop cleaning options are also supported.

- Five 1m flexible extensions
- Premium 6" poly brush
- Threaded metal connectors
- Pull through option on brush

6" PULL THRU FLUE BRUSH KIT

Simply attach the snap-lock weighted ball and chain and brush to each end of the rope provided for a pull thru flue cleaning solution.

- Weighted ball and chain
- 10m rope extension
- Snaplock connectors
- Heavy duty poly brush

SMALL CHILD SAFETY GUARD

This sturdy child safety guard minimises the risk of coming into contact with what can be extremely hot surfaces. Suits most mid size wood fires.

- Heavy duty steel construction
- Dual opening door (685w x 600h)
- Rear stabilising bar
- Size (mm): 1080w x 1055d x 800h

LARGE CHILD SAFETY GUARD

This sturdy child safety guard will minimise the risk of coming into contact with what can be extremely hot surfaces. Suits most large wood fires.

- Heavy duty steel construction
- Dual opening door (860w x 600h)
- Rear stabilising bar
- Size (mm): 1275w x 1275d x 800h

SMALL CORNER CHILD SAFETY GUARD

This sturdy child safety guard minimises the risk of coming into contact with what can be extremely hot surfaces. Designed to accommodate corner installations for most mid size wood fires.

- Heavy duty steel construction
- Dual opening door (720w x 600h)
- Rear wall secure points
- Size (mm): 1890w x 650d x 800h

LARGE CORNER CHILD SAFETY GUARD

This sturdy child safety guard will minimise the risk of coming into contact with what can be extremely hot surfaces. Designed to accommodate corner installations for most large wood fires.

- Heavy duty steel construction
- Dual opening door (860w x 600h)
- Rear wall secure points
- Size (mm): 2050w x 720d x 800h

ADDITIONAL INSTALLATION ITEMS

Additional parts required to complete your installation are available from Bunnings stores. Items not in stock can be ordered from the Special Orders desk – ask in store or visit the website for details.

- Kits available:**
- 1m Flue Extensions
 - 45° Bends
 - Roof Flashing
 - Flexi Flue and Adapters
 - Penetration and Drop Boxes

ZERO CLEARANCE KIT

Zero clearance kits are required when installing an inbuilt wood heater into a timber framed stud wall. Zero clearance kits are available for all Scandia inbuilt wood fires. Ask in store or visit the website for details.

- Kits available:**
- Warmbrite Zero Clearance Box
 - 6"-10" Zero Clearance Flue Kit
 - Avante Zero Clearance Box
 - 10"-14" Zero Clearance Flue Kit
 - Styliste' 6 Zero Clearance Box
 - Styliste' 10 Zero Clearance Box



Black Mesh Default Flue Kit. Item no: 3180672



Inbuilt Flue kit. Item no: 3170671



Black Mesh Internal Bend kit. Item no: 3170794



6" Extendable Flue Brush. Item no: 3180729



Small child safety guard. Item no: 3180726



Small corner child safety guard. Item no: 3171518



Sleek Black Default Flue Kit. Item no: 3171486



Graphite Default Flue Kit. Item no: 3171486



Sleek black internal bend kit. Item no: 3171250



6" Pull thru flue brush kit. Item no: 3171521



Large child safety guard. Item no: 3180725



Large corner child safety guard. Item no: 3171519

TECHNICAL INFORMATION

PROFESSIONAL INSTALLATION

It is a requirement that all Scandia solid fuel and gas appliances are fitted by a qualified, licensed installer whose work complies with local council regulations, Australian standards and manufacturer's specifications. Failure to correctly install is extremely dangerous, will void any warranty claims and may compromise any future insurance claims.



For a professional installation we recommend calling **1300 FIDDIT (1300 343 348)** or book online at www.fiddit.com.au

HEATER DIMENSIONS AND INSTALLATION CLEARANCES

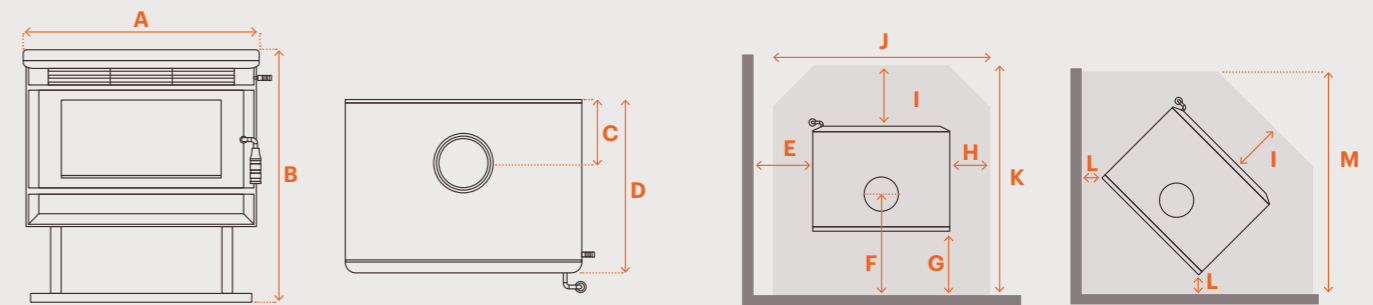

SCANDIA APPLIANCE COMPARISON CHART										
	Firebox thickness	3 speed fan	Heating capacity	Emissions	Efficiency	Average kW Rating	Peak kW Rating	Net weight	Gross weight	Packaged (mm) W x D x H
WARMBRITE 140	5mm	No	140m ²	1.5g/kg	63%	15.6kW	18kW	85kg	99kg	580 x 580 x 860
WARMBRITE 200	5.5mm	Yes	200m ²	1.1g/kg	67%	7.9kW	12.1kW	144kg	160kg	780 x 650 x 880
STACKER 200	5.5mm	Yes	200m ²	1.1g/kg	67%	7.9kW	12.1kW	159kg	179kg	780 x 650 x 1000
WARMBRITE 300	5.5mm	Yes	300m ²	1.3g/kg	62%	10.1kW	14.4kW	183kg	203kg	889 x 710 x 960
STACKER 300	5.5mm	Yes	300m ²	1.3g/kg	62%	10.1kW	14.4kW	198kg	218kg	885 x 715 x 1090
WARMBRITE 200i-S3	5.5mm	Yes	180m ²	0.4g/kg	61%	9.0kW	12.1kW	116kg	135kg	780 x 620 x 710
WARMBRITE 300i-S3	5.5mm	Yes	280m ²	0.9g/kg	61%	9.5kW	14.1kW	143kg	166kg	880 x 670 x 750
HEAT & COOK	5mm	No	200m ²	N/A	N/A	N/A	N/A	229kg	246kg	770 x 710 x 1070
SUPREMACY 200	8mm	Yes	200m ²	1.1g/kg	67%	10.2kW	14.2kW	186kg	207kg	775 x 645 x 870
SUPREMACY 300	8mm	Yes	300m ²	0.9g/kg	69%	13.9kW	18.2kW	226kg	247kg	880 x 745 x 930
HELIX	3.5mm	No	200m ²	1.5g/kg	62%	7.0kW	9.9kW	155kg	178kg	720 x 570 x 1310
EDGE 50	5mm	No	200m ²	1.3g/kg	62%	6.4kW	9.4kW	98kg	115kg	665 x 592 x 655
EDGE 70	5mm	No	320m ²	0.5g/kg	60%	11.4kW	16.2kW	145kg	165kg	710 x 820 x 780
VERDANT LE	3mm	Variable	200m ²	0.8g/kg	79%	6.9kW	7.8kW	102kg	118kg	460 x 460 x 1150
AVANTE	6mm	No	150m ²	N/A	N/A	N/A	N/A	195kg	215kg	1030 x 630 x 700
STYLISTE 6	5.5mm	No	200m ²	1.4g/kg	63%	7.7kW	11.7kW	146kg	160kg	732 x 582 x 670
STYLISTE 10	5.5mm	No	300m ²	1.1g/kg	60%	11.5kW	16.2kW	175kg	195kg	1152 x 582 x 670
AVEDUR	-	Yes	70m ²	-	79%	5.6kW	-	112kg	138kg	1345 x 575 x 1210

FREESTANDING HEATER DIMENSIONS

	UNIT SIZE (mm)						INTERNAL FIREBOX (mm)		
	A	B	C	D	FLUE Ø	WEIGHT	WIDTH	DEPTH	HEIGHT
WARMBRITE 140	500	735	137	450	152	85 kg	370	330	-
WARMBRITE 200	673	735	197	530	152	144 kg	445	305	-
STACKER 200	673	865	197	530	152	159 kg	445	305	-
WARMBRITE 300	770	810	206	580	152	183 kg	545	365	-
STACKER 300	770	910	206	580	152	191kg	545	365	-
HEAT & COOK	650	865	112	565	152	229 kg	428	330	-
OVEN SIZE (mm)							433	373	305
STYLISTE' 6	640	500	141	525	152	146kg	570	400	315
STYLISTE' 10	1060	500	151	525	152	175kg	930	399	316
SUPREMACY 200	655	725	196	575	152	186 kg	445	365	-
SUPREMACY 300	755	765	206	662	152	226 kg	545	470	-
HELIX	615	1160	203	450	152	155 kg	400	335	585
EDGE 50	620	775	151	480	152	98kg	435	334	-
EDGE 70	710	970	221	600	152	145 kg	600	420	-
VERDANT LE	510	960	-	440	80	102kg	200	150	500

FREESTANDING INSTALLATION CLEARANCES

	CLEARANCES TO COMBUSTIBLE SURFACES (mm)									
	E	F	G	H	I	J	K	L	M	
WARMBRITE 140	625	496	275	145	350	745	1005	385	1520	
WARMBRITE 200	250	346*	150*	120	450	900	1110	100*	1255	
STACKER 200	250	346*	150*	120	450	900	1110	100	1255	
WARMBRITE 300	350	381*	175*	120	450	1000	1175	170*	1425	
STACKER 300	350	381*	175*	120	450	1000	1175	170*	1425	
HEAT & COOK	425	287	175*	95	300	820	1040	200	1250	
STYLISTE' 6	400	441	300	120	300	880	1125	200	1217	
STYLISTE' 10	500	451	300	120	500	1300	1300	200	1653	
SUPREMACY 200	350	346	150*	120	300	950	1010	75	1220	
SUPREMACY 300	400	356	150*^	120	300	1040	1125	75	1350	
HELIX	410	503	300*	70	300	770	1043	280	1325	
EDGE 50	650	301	150	108	300	835	930	350	1375	
EDGE 70	1200	471	250*	130	300	950	1150	600	1720	
VERDANT LE	100	-	220**	62.5	300	635	780	25	909	

*with decorative flue, with at least 180° heat shield and 900mm 180° flue shield in place.

^with tertiary 550mm 180° heat shield in place (supplied with heater).

**vertical flue 200mm and horizontal flue 80mm.

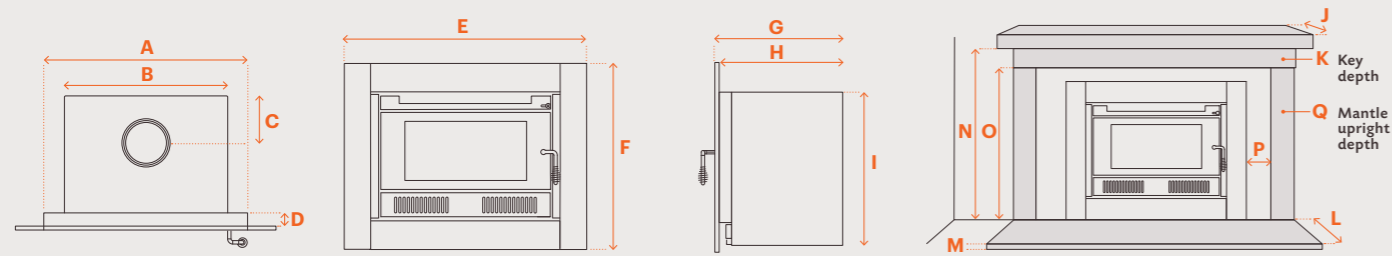

INBUILT HEATER DIMENSIONS

*firebox including front support brackets, excluding decorative fascia

UNIT SIZE (mm)											
	A	B	C	D	E	F	G	H	I	FLUE Ø	WEIGHT
WARMBRITE 200i-S3	696	573	169	65	923	695	472	457	562	152	116 kg
FLOOR MOUNT (Optional)	-	-	-	-	1013	719	-	-	-	-	-
WARMBRITE 300i-S3	795	673	165	65	1015	735	518	503	605	152	143 kg
FLOOR MOUNT (Optional)	-	-	-	-	1113	760	-	-	-	-	-
AVANTE OPEN FIRE	1000*	910	152	60	1294	644	577	515	770	254	195 kg
AVEDUR	SEE OWNERS MANUAL FOR DETAILS										
STYLISTE 6	639	785	141	-	726	579	-	525	500	152	-
FLOOR MOUNT (Optional)	639	785	141	-	726	534	-	525	500	-	-
STYLISTE 10	1060	785	151	-	1146	584	-	525	500	152	-
FLOOR MOUNT (Optional)	1060	785	151	-	1146	534	-	525	500	-	-

CLEARANCE TO COMBUSTIBLES (mm) FOR MASONRY FIREPLACE

CLEARANCES TO COMBUSTIBLE SURFACES (mm)									INTERNAL FIREBOX (mm)		
	J	K	L	M	N	O	P	Q	WIDTH	DEPTH	
WARMBRITE 200i-S3	250	40	550	30	1070	900	30	40	445	305	
WARMBRITE 300i-S3	250	40	550	30	1070	900	30	40	545	365	
STYLISTE 6	SEE OWNERS MANUAL FOR DETAILS									570	400
STYLISTE 10	SEE OWNERS MANUAL FOR DETAILS									930	399
AVANTE OPEN FIRE	SEE OWNERS MANUAL FOR DETAILS									890	450
AVEDUR	SEE OWNERS MANUAL FOR DETAILS									-	-

STRUKTUR MODULE DIMENSIONS

	WIDTH	DEPTH	HEIGHT
STRUKTUR MODULE / TOP BOX 6	640	525	250
STRUKTUR MODULE / TOP BOX 5	530	525	250
STRUKTUR CORNER BOX	525	525	250



For specifications relating to installation requirements and Zero clearance installations please refer to owners manual. Brochure should be used as a guide only.

CLEAR SKIES, CLEAR CONSCIENCE

When you purchase a Scandia wood fire, you can be confident in the knowledge that you are purchasing the only sustainable and most affordable renewable source of home heating available.

As a supporter and sponsor of Landcare Australia, Scandia is mindful of any impact on the environment. Therefore, it's reassuring to us to know that 98 per cent of hardwood burnt in Australia is sustainably sourced, and by choosing to burn this firewood in a Scandia wood fire, you will generate no additional CO2 emissions than if that same wood were left to decompose naturally in the bush. (Kerryn Paul, 2003)

To control the amount of emissions released into the environment, Scandia designs all combustion wood fires with a two stage, primary and secondary air system. While the primary air controls the rate of burn, the secondary air system hyper-heats any excess carbon, converting the majority of residual emissions into energy which is then stored in the firebricks and firebox, improving overall efficiency of the heater and minimising any impact on the environment.

As an organisation, Scandia is committed to helping the environment through the promotion of renewable energy, sustainable harvesting practices and a commitment to programs that focus on reducing carbon emissions.

DISCLAIMER

Due to our policy of continuous improvement of our products and services, technical specifications and claims, correct at the time of going to print, may be subject to variation without prior notice. Scandia Heating (Aust) Pty Ltd has endeavoured to ensure that the information in this document is correct and fairly stated, but does not accept liability for any error or omission.

Scandia Heating (Aust) Pty Ltd accepts no liability whatsoever for their interpretation of AS/NZS 2918-2001, AS/NZS 4012-4013. All heating capacities quoted are based on units tested with quality hardwood. Minimal performance reduction may result due to large glassed areas, vaulted ceilings, draughts or insufficient insulation. We reserve the right to alter specifications without notice.

