

MAINTENANCE

WARNING! ENSURE THE TOOL IS DISCONNECTED FROM THE POWER SUPPLY BEFORE PERFORMING ANY OF THE FOLLOWING OPERATIONS.

NOTE: The trimmer has two removable plastic blades that can be quickly and easily replaced.

Blades can be purchased in packs of 20 (Ozito part number PXCLTA-020) and are available from your local Bunnings Warehouse.

Removing Blades

1. Push the blade toward the centre of the trimmer to release.
2. Lift the blade off the blade attachment knob.

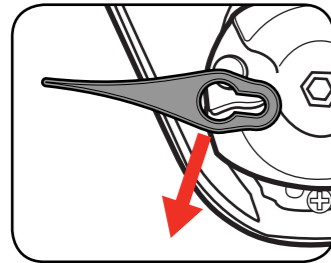
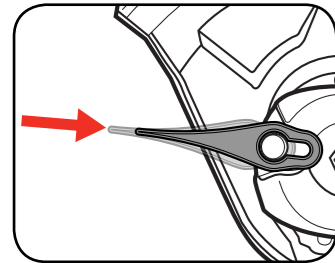

Fitting Blades

1. Position the blade over the blade attachment knob.
2. Pull the blade outwards to lock it into place.

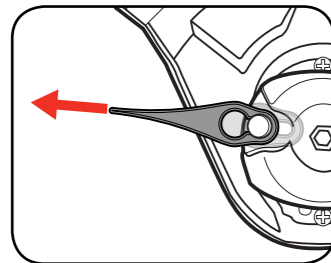
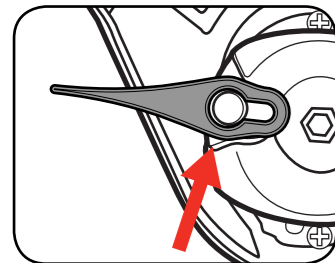

- Keep ventilation slots of the trimmer clean at all times. Periodically clean out the grass from the cutting head and the rim of the blade guard to ensure efficient operation at all times.
- After each use, blow air through the tool housing to ensure it is free from all dust, dirt, etc. Build up of dust, dirt particles may cause the tool to overheat and shorten the life of the tool.
- If the housing of the trimmer requires cleaning, do not use solvents but a moist soft cloth or soft brush only.
- Never let any liquid get inside the tool, never immerse any part of the tool into liquid.
- No lubrication is necessary as the tool has sealed bearings.
- When not in use, the grass trimmer should be stored in a dry, frost free location not within the reach of children.

Note: Ozito Industries will not be responsible for any damage or injuries caused by the repair of the grass trimmer by an unauthorised person or by mishandling of the grass trimmer. This tool is designed for DIY use - use in commercial or industrial environments will void the warranty.

CARING FOR THE ENVIRONMENT



Power tools that are no longer usable should not be disposed of with household waste but in an environmentally friendly way. Please recycle where facilities exist. Check with your local council authority for recycling advice.



Recycling packaging reduces the need for landfill and raw materials. Reuse of recycled material decreases pollution in the environment. Please recycle packaging where facilities exist. Check with your local council authority for recycling advice.

DESCRIPTION OF SYMBOLS

V	Volts	Hz	Hertz
~	Alternating current	W	Watts
/min	Revolutions or reciprocation per minute	∅	No load speed
	Double insulated		Regulator compliance mark
	Warning		Read instruction manual
	Wear eye protection		Do not operate in the rain
	Keep bystanders away		Keep bystanders away
	Disconnect the mains plug if the cord is damaged or entangled		Decibel level

TROUBLESHOOTING

Problem	Cause	Remedy
Grass wraps around the attachment shaft and the trimmer head.	Cutting tall grass at ground level.	Make several passes from top down.

SPARE PARTS

Blades (Pack 20)	PXCLTA-020
Blade Guard	SPGTR250-30

Spare parts can be ordered from the Special Orders Desk at your local Bunnings Warehouse.

For further information, or any parts not listed here, visit

www.ozito.com.au or contact Ozito Customer Service:

Australia 1800 069 486

New Zealand 0508 069 486

E-mail: enquires@ozito.com.au

ELECTRICAL SAFETY

WARNING! When using mains-powered tools, basic safety precautions, including the following, should always be followed to reduce risk of fire, electric shock, personal injury and material damage.

Read the whole manual carefully and make sure you know how to switch the tool off in an emergency, before operating the tool.

Save these instructions and other documents supplied with this tool for future reference.

The electric motor has been designed for 230V and 240V only. Always check that the power supply corresponds to the voltage on the rating plate.

Note: The supply of 230V and 240V on Ozito tools are interchangeable for Australia and New Zealand.

This tool is double insulated therefore no earth wire is required.

To reduce the risk of electrical shock, a residual current device (rated 30mA or less) must be used.

GENERAL POWER TOOL SAFETY WARNINGS

WARNING! Read all safety warnings and all instructions. Failure to follow the warnings and instructions may result in electric shock, fire and/or serious injury.

Save all warnings and instructions for future reference. The term "power tool" in the warnings refers to your mains-operated (corded) power tool or battery-operated (cordless) power tool.

1. Work area safety

a. Keep work area clean and well lit. Cluttered or dark areas invite accidents.

b. Do not operate power tools in explosive atmospheres, such as in the presence of flammable liquids, gases or dust. Power tools create sparks which may ignite the dust or fumes.

c. Keep children and bystanders away while operating a power tool. Distractions can cause you to lose control.

2. Electrical safety

a. Power tool plugs must match the outlet. Never modify the plug in any way. Do not use any adapter plugs with earthed (grounded) power tools. Unmodified plugs and matching outlets will reduce risk of electric shock.

b. Avoid body contact with earthed or grounded surfaces, such as pipes, radiators, ranges and refrigerators. There is an increased risk of electric shock if your body is earthed or grounded.

c. Do not expose power tools to rain or wet conditions. Water entering a power tool will increase the risk of electric shock.

d. Do not abuse the cord. Never use the cord for carrying, pulling or unplugging the power tool. Keep cord away from heat, oil, sharp edges or moving parts. Damaged or entangled cords increase the risk of electric shock.

e. When operating a power tool outdoors, use an extension cord suitable for outdoor use. Use of a cord suitable for outdoor use reduces the risk of electric shock.

f. If operating a power tool in a damp location is unavoidable, use a residual current device (RCD) protected supply. Use of an RCD reduces the risk of electric shock.

3. Personal safety

a. Stay alert, watch what you are doing and use common sense when operating a power tool. Do not use a power tool while you are tired or under the influence of drugs, alcohol or medication. A moment of inattention while operating power tools may result in serious personal injury.

b. Use personal protective equipment. Always wear eye protection. Protective equipment such as dust mask, non-skid safety shoes, hard hat, or hearing protection used for appropriate conditions will reduce personal injuries.

c. Prevent unintentional starting. Ensure the switch is in the off-position before connecting to power source and/or battery pack, picking up or carrying the tool. Carrying power tools with your finger on the switch or energising power tools that have the switch on invites accidents.

If the supply cord is damaged, it must be replaced by an electrician or a power tool repairer in order to avoid a hazard.

Note: Double insulation does not take the place of normal safety precautions when operating this tool. The insulation system is for added protection against injury resulting from a possible electrical insulation failure within the tool.

Using an Extension Lead

Always use an approved extension lead suitable for the power input of this tool. Before use, inspect the extension lead for signs of damage, wear and ageing. Replace the extension lead if damaged or defective.

When using an extension lead on a reel, always unwind the lead completely. Use of an extension lead not suitable for the power input of the tool or which is damaged or defective may result in a risk of fire and electric shock.

Supply cords shall not be lighter than:

- if rubber insulated, ordinary tough rubber sheathed flexible cord (code designation 60227 IEC 53);

- if polyvinyl chloride insulated, ordinary polyvinyl chloride sheathed flexible cord (code designation 60227 IEC 53).

ozito

ELECTRIC GRASS TRIMMER

250W 230mm

INSTRUCTION MANUAL

SPECIFICATIONS

Voltage:	230-240V - 50Hz
Power:	250W
No Load Speed:	12,000/min
Cutting Diameter:	230mm
Cutting System:	Dual Blade
Noise Level:	96dB
Weight:	1.5kg

ozito.com.au

3 YEAR REPLACEMENT WARRANTY

WARRANTY

IN ORDER TO MAKE A CLAIM UNDER THIS WARRANTY YOU MUST RETURN THE PRODUCT TO YOUR NEAREST BUNNINGS WAREHOUSE WITH YOUR BUNNINGS REGISTER RECEIPT. PRIOR TO RETURNING YOUR PRODUCT FOR WARRANTY PLEASE TELEPHONE OUR CUSTOMER SERVICE HELPLINE:

Australia 1800 069 486

New Zealand 0508 069 486

TO ENSURE A SPEEDY RESPONSE PLEASE HAVE THE MODEL NUMBER AND DATE OF PURCHASE AVAILABLE. A CUSTOMER SERVICE REPRESENTATIVE WILL TAKE YOUR CALL AND ANSWER ANY QUESTIONS YOU MAY HAVE RELATING TO THE WARRANTY POLICY OR PROCEDURE.

The benefits provided under this warranty are in addition to other rights and remedies which are available to you at law.

Our goods come with guarantees that cannot be excluded at law. You are entitled to a replacement or refund for a major failure and for compensation for any other reasonably foreseeable loss or damage. You are also entitled to have the goods repaired or replaced if the goods fail to be of acceptable quality and the failure does not amount to a major failure.

Generally you will be responsible for all costs associated with a claim under this warranty, however, where you have suffered any additional direct loss as a result of a defective product you may be able to claim such expenses by contacting our customer service helpline above.

3 YEAR REPLACEMENT WARRANTY

Your product is guaranteed for a period of **36 months from the original date of purchase** and is intended for DIY (Do It Yourself) use only. If a product is defective it will be replaced in accordance with the terms of this warranty. Warranty excludes consumable parts, for example: carbon brushes, blades, safety guard etc.

WARNING

The following actions will result in the warranty being void.

- If the tool has been operated on a supply voltage other than that specified on the tool.
- If the tool shows signs of damage or defects caused by or resulting from abuse, accidents or alterations.
- Failure to perform maintenance as set out within the instruction manual.
- If the tool is disassembled or tampered with in any way.
- Professional, industrial or high frequency use.

WHAT'S IN THE BOX

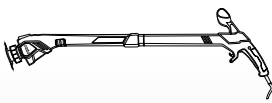

Grass Trimmer



Blade Guard



Cutting Blades x 2



Assembly Screws x 2

LMBLGTK-000

KNOW YOUR PRODUCT

ELECTRIC GRASS TRIMMER (GTR-250)

- 1. Cutting Blades
- 2. Blade Guard
- 3. Secondary Handle
- 4. Cord Retainer
- 5. Lock-off Button
- 6. On/Off Trigger
- 7. Main Handle
- 8. Blade Attachment Knob

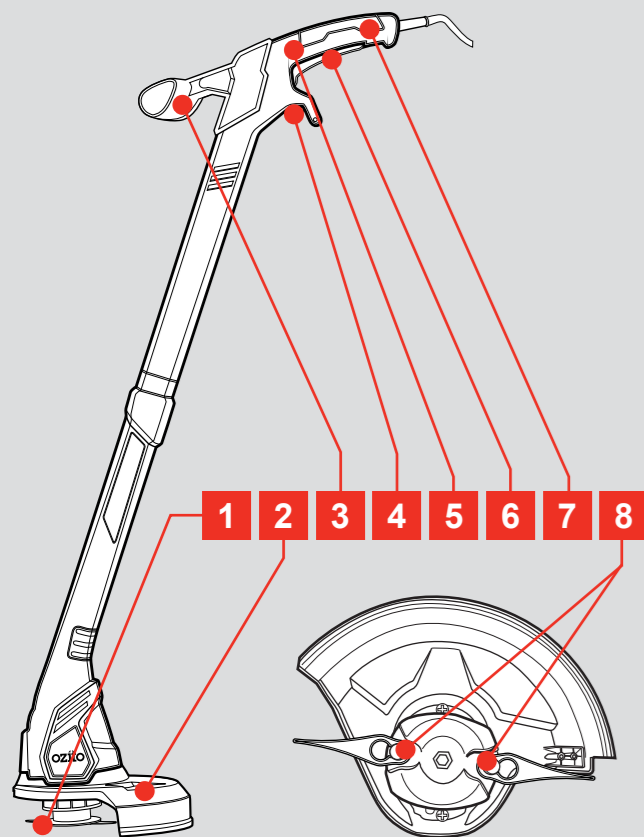

- 9. Assembly Screws



9

ONLINE MANUAL

Scan this QR Code with your mobile device to take you to the online manual.



SETUP & PREPARATION

1. ASSEMBLY

WARNING! ENSURE THE TOOL IS DISCONNECTED FROM THE POWER SUPPLY BEFORE PERFORMING ANY OF THE FOLLOWING OPERATIONS.

Upper Handle

1. Fit the upper handle assembly onto the lower housing and insert it as far as possible.

Note: The two halves will only go together one way.

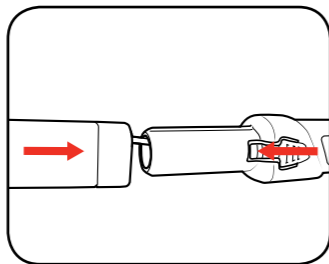

Fitting the Blade Guard

1. Turn the trimmer upside down.

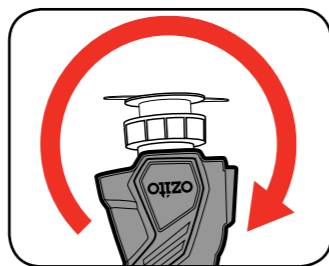

2. Place the blade guard over the cutting head, making sure to align both the ridges of the blade guard with the grass trimmer housing.

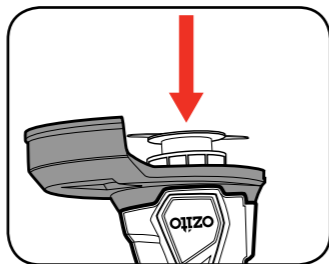

3. Secure with the 2 supplied screws.

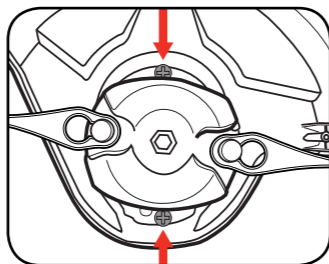

WARNING! NEVER USE THE GRASS TRIMMER UNLESS THE BLADE GUARD IS PROPERLY FITTED AND SECURED.

2. CORD RETAINER

Using the Cord Retainer

1. Make a loop with the extension cord and push it through the hole under the on/off trigger.
2. Place the loop onto the cord retainer and ensure it is pulled firmly into place.

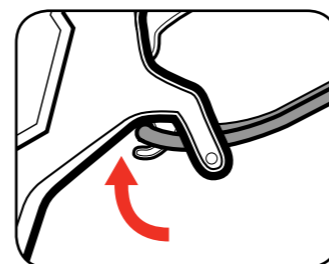
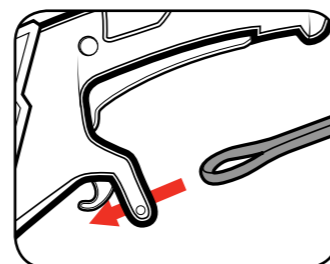

3. Connect the extension cord socket to the grass trimmer cord.

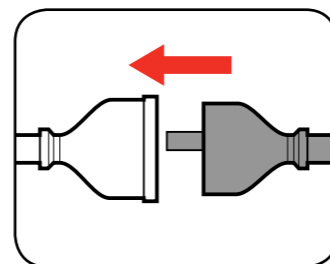

NOTE: TO AVOID THE EXTENSION CORD FROM DETACHING; ALWAYS CHECK THAT THE CORD IS ATTACHED TO THE CORD RETAINER BEFORE USE.

3. CHECKS PRIOR TO OPERATION

WARNING! ENSURE THE TOOL IS DISCONNECTED FROM THE POWER SUPPLY BEFORE PERFORMING ANY OF THE FOLLOWING OPERATIONS.

Before Using the Grass Trimmer

1. Check that the blades are not damaged. If so follow the steps in the maintenance section to fit new blades.
2. Make sure that the blade guard is attached securely.

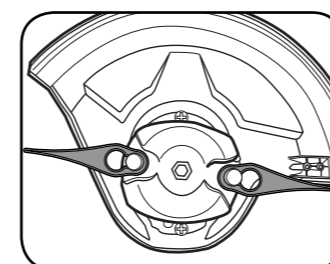

3. Check that the extension cord is positioned in the cord retainer firmly.

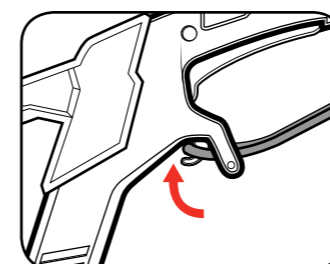

WARNING! MAKE SURE THAT THE WORK AREA IS FREE OF ROCKS, DEBRIS, LINES AND OTHER FOREIGN OBJECTS.

OPERATION

4. CONTROLS

WARNING! TO REDUCE THE RISK OF ELECTRIC SHOCK, THE USE OF A RESIDUAL CURRENT DEVICE RATED AT 30mA OR LESS IS RECOMMENDED.

On/Off Trigger

For your safety this Grass Trimmer is designed with a safety lock off mechanism to prevent accidental starting. If you only squeeze the On/Off switch the Grass Trimmer will not start.

1. To switch ON, depress and hold the lock-off button whilst squeezing the On/Off switch.

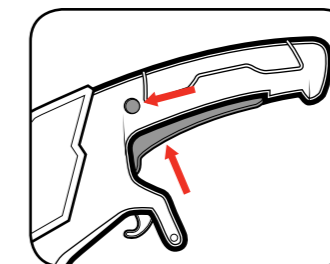

2. Once started the lock-off button can be released.

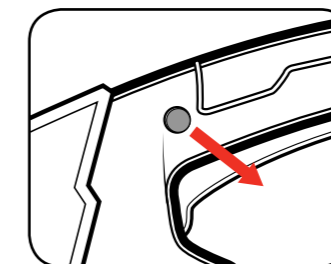

3. To turn OFF release the On/Off trigger.

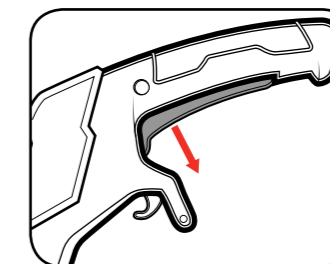

WARNING! THE GRASS TRIMMER MAY RUN FOR A FEW SECONDS AFTER IT HAS BEEN SWITCHED OFF. LET THE MOTOR COME TO A COMPLETE STANDSTILL BEFORE SETTING THE TOOL DOWN.

5. USING THE GRASS TRIMMER

Using the Grass Trimmer

CAUTION! DO NOT CONTINUALLY TAP, BUMP OR HOLD THE SPOOL/BLADE HOLDER ON THE GROUND AS THIS MAY RESULT IN DAMAGE TO THE SPOOL/BLADE HOLDER, BLADES OR OVERLOAD THE UNIT.

- Wear eye protection and stout shoes at all times while operating the grass trimmer.

- Start cutting nearest the mains power source and work away to make it easier to avoid the extension cord.

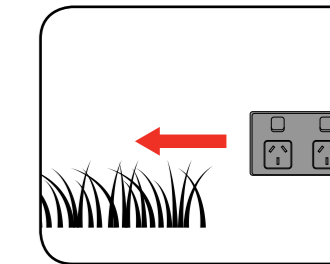

- Do not push plastic blades against hard material (rocks or concrete) during cutting as this may result in damaged blades.
- Never use the grass trimmer without its safety devices.
- Do not cut grass that is wet. (The best results are achieved on dry grass).
- Wait until the grass trimmer reaches full speed before cutting the grass

- Move the grass trimmer from side to side as you walk forward, holding it at an angle of approx. 30° (Light cuts are better than heavy cuts as they allow the cut grass to fall away from the cutting head.).

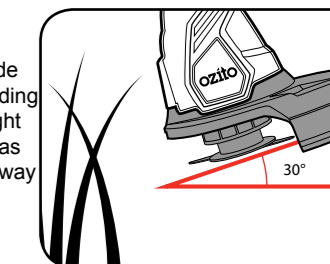

- Keep the grass trimmer away from hard objects in order to avoid unnecessary blade wear and/or damage. In the event of broken blades, you will have to fit new blades to continue operation.

- Several passes will be required to cut long grass as shown.

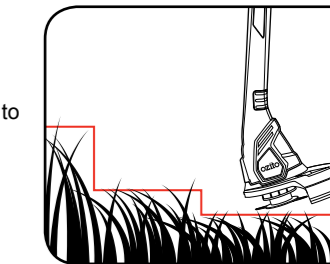

- To prevent the blade from breaking ensure you approach the edge/object slowly and let the TIP of the blade do the work.
- Watch out for kickbacks in the event of impact with hard objects.
- After finishing the cutting operation, keep the head close to ground level, release the switch and allow the motor to come to a complete standstill. Unplug and place the grass trimmer on the ground.
- Keep ventilation slots of the trimmer clean at all times. Periodically clean out the grass from the cutting head and the rim of the blade guard to ensure efficient operation at all times.

MAINTENANCE

WARNING! BEFORE CLEANING YOUR ECOMOW ELECTRIC MOWER OR CARRYING OUT ANY MAINTENANCE PROCEDURE, MAKE SURE THAT THE MOTOR IS OFF AND THE TOOL DISCONNECTED FROM THE POWER SUPPLY TO PREVENT ACCIDENTAL STARTING.

Removing the Blade

CAUTION! DO NOT TOUCH ROTATING BLADES.

CAUTION! ALWAYS HANDLE THE BLADE WITH CARE – SHARP EDGES COULD CAUSE SERIOUS INJURY. USE GLOVES.

- To remove the blade bolt, hold the blade firmly and with a 13mm spanner (not supplied) loosen the blade bolt by turning it anti-clockwise.
- Remove the blade bolt, and blade.
- Inspect for damage and clean as necessary.

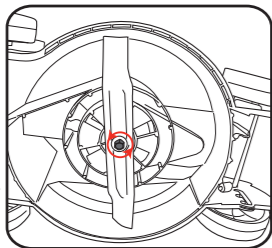

Renew the metal blade after 50 hours mowing or 2 years whichever is the sooner – regardless of condition. If the blade is cracked or damaged replace it with a new one. Never use a blade bolt if the insulated head is damaged, cracked or missing.

Fitting the Blade

- Fit the blade to the fan with the tilt edges of the blade facing towards the mower, ensuring the blade is located onto the fan location points correctly.
- Re-assemble blade bolt through blade and fan.
- Hold the fan firmly and tighten blade bolt with a 13mm spanner, by turning in a clockwise direction. Do not over tighten.

Ozito Industries will not be responsible for any damage or injuries caused by repair of the tool by an unauthorised person or mishandling or mistreatment of the tool. This tool is designed for Domestic Home Use only. Use in commercial or industrial environments will void the warranty.

- Keep all nuts, bolts and screws tight to be sure the lawn mower is in a safe working condition.
- Check the catcher frequently for wear or deterioration.
- Replace worn or damaged parts for safety.
- Only use the replacement blade, blade bolt, and impeller specified for this product.
- Be careful during adjustments of the lawn mower to prevent entrapment of the fingers between moving blade and fixed parts of the machine.
- Oil the wheel pins.
- When not in use, the mower should be stored in a dry, frost-free location, out of reach of children. If the housing of the mower requires cleaning, do not use solvents but a moist soft cloth and brush only.
- Frequently check the wheel threads are firm and tight.

DESCRIPTION OF SYMBOLS

V	Volts	Hz	Hertz
~	Alternating current	W	Watts
/min	Revolutions or reciprocation per minute	No	No load speed
	Double insulated		Regulator compliance mark
	Read instruction manual		The sound power level indicates by L _{WA} in dB
	Disconnect the mains plug if the cord is damaged or entangled		Warning
	Don't use on steep slopes.		Don't use with rear flap open.
	Beware of severing toes or hands. Do not put hands or feet near a rotating blade.		
	Keep bystanders away. Do not mow whilst people especially children or pets are in the mowing area.		
	Always keep the lawnmower on the ground when mowing. Tilting or lifting the lawnmower may cause stones to be thrown out.		
	Blades continue to rotate after machine is switched off		
	Switch Off! Remove plug from mains before adjusting, cleaning or if cable is entangled or damaged. Keep the cable away from the blade.		

SPARE PARTS

Switch Box Assy.	SPELM1000-06
Belt	SPELM1000-30
Blade (accessory)	ELMA-1001
Blade Bolt	SPELM1000-35
Tension Spring	SPELM1000-40

Spare parts can be ordered from the Special Orders Desk at your local Bunnings Warehouse.

For further information, or any parts not listed here, visit www.ozito.com.au or contact Ozito customer service
Australia 1800 069 486
New Zealand 0508 069 486
E-mail: enquires@ozito.com.au

CARING FOR THE ENVIRONMENT



Tools that are no longer usable should not be disposed of with household waste but in an environmentally friendly way. Please recycle where facilities exist. Check with your local council authority for recycling advice.



Recycling packaging reduces the need for landfill and raw materials. Reuse of recycled material decreases pollution in the environment. Please recycle packaging where facilities exist. Check with your local council authority for recycling advice.

ELECTRICAL SAFETY

WARNING! When using mains-powered tools, basic safety precautions, including the following, should always be followed to reduce risk of fire, electric shock, personal injury and material damage.

Read the whole manual carefully and make sure you know how to switch the tool off in an emergency, before operating the tool. Save these instructions and other documents supplied with this tool for future reference. The electric motor has been designed for 230V and 240V only. Always check that the power supply corresponds to the voltage on the rating plate.

Note: The supply of 230V and 240V on Ozito tools are interchangeable for Australia and New Zealand.

This tool is double insulated therefore no earth wire is required.

If the supply cord is damaged, it must be replaced by an electrician or a power tool repairer in order to avoid a hazard.

Note: Double insulation does not take the place of normal safety precautions when operating this tool. The insulation system is for added protection against injury resulting from a possible electrical insulation failure within the tool.

- Before use, examine cord for damage; replace it if there are signs of damage or ageing.
- Do not use the lawn mower if the electric cables are damaged or worn.

GENERAL POWER TOOL SAFETY WARNINGS

WARNING! Read all safety warnings and all instructions. Failure to follow the warnings and instructions may result in electric shock, fire and/or serious injury. Save all warnings and instructions for future reference.

The term "power tool" in the warnings refers to your mains-operated (corded) power tool or battery-operated (cordless) power tool.

- Work area safety**
 - Keep work area clean and well lit. Cluttered or dark areas invite accidents.
 - Do not operate power tools in explosive atmospheres, such as in the presence of flammable liquids, gases or dust. Power tools create sparks which may ignite the dust or fumes.
 - Keep children and bystanders away while operating a power tool. Distractions can cause you to lose control.
- Electrical safety**
 - Power tool plugs must match the outlet. Never modify the plug in any way. Do not use any adapter plugs with earthed (grounded) power tools. Unmodified plugs and matching outlets will reduce risk of electric shock.
 - Avoid body contact with earthed or grounded surfaces, such as pipes, radiators, ranges and refrigerators. There is an increased risk of electric shock if your body is earthed or grounded.
 - Do not expose power tools to rain or wet conditions. Water entering a power tool will increase the risk of electric shock.
 - Do not abuse the cord. Never use the cord for carrying, pulling or unplugging the power tool. Keep cord away from heat, oil, sharp edges or moving parts. Damaged or entangled cords increase the risk of electric shock.
 - When operating a power tool outdoors, use an extension cord suitable for outdoor use. Use of a cord suitable for outdoor use reduces the risk of electric shock.
 - If operating a power tool in a damp location is unavoidable, use a residual current device (RCD) protected supply. Use of an RCD reduces the risk of electric shock.
- Personal safety**
 - Stay alert, watch what you are doing and use common sense when operating a power tool. Do not use a power tool while you are tired or under the influence of drugs, alcohol or medication. A moment of inattention while operating power tools may result in serious personal injury.
 - Use personal protective equipment. Always wear eye protection. Protective equipment such as dust mask, non-skid safety shoes, hard hat, or hearing protection used for appropriate conditions will reduce personal injuries.
 - Prevent unintentional starting. Ensure the switch is in the off-position before connecting to power source and/or battery pack, picking up or carrying the tool. Carrying power tools with

ADDITIONAL SAFETY INSTRUCTIONS FOR LAWN MOWERS

WARNING! If not used properly this lawn mower can be dangerous!
 This lawn mower can cause serious injury to the operator and others, the warnings and safety instructions must be followed to ensure reasonable safety and efficiency in using this lawn mower. The operator is responsible for following the warning and safety instructions in this manual and on the lawn mower. Never use the mower unless the catcher or guards provided by the manufacturer are in the correct position.

- Training**
 - Read the instructions carefully. Be familiar with the controls and the proper use of the appliance.
 - Never allow children or people unfamiliar with these instructions to use the appliance. Local regulations may restrict the age of the operator.
 - Never mow while people, especially children, or pets are nearby.
 - The operator or user is responsible for accidents or hazards occurring to other people or their property.
- Preparation**
 - While mowing, always wear substantial footwear and long trousers.
 - Do not operate the appliance when barefoot or wearing open sandals.
 - Thoroughly inspect the area where the appliance is to be used and remove all stones, sticks, wires, bones, and other foreign objects.
 - Before using, always visually inspect to see that the blades, blade bolts and cutter assembly are not worn or damaged. Replace worn or damaged blades and bolts in sets to preserve balance.
 - On multi-bladed appliances, take care as rotating one blade can cause other blades to rotate.
- Operation**
 - Mow only in daylight or in good artificial light.
 - Avoid operating the appliance in wet grass, where feasible.
 - Always be sure of your footing on slopes.
 - Walk, never run.
 - For wheeled rotary mowers, mow across the face of slopes, never up and down.

- Immediately disconnect from the mains electricity supply if the cord is cut, or the insulation is damaged. Do not touch the electric cord until the electricity supply has been disconnected. Do not repair a cut or damaged cord; replace it with a new one.
- Your extension lead must be unwound, coiled leads can overheat and reduce the efficiency of your mower.
- Keep lead away from lawn mower; always work away from the power point mowing up and down never in circles.
- Do not pull lead around sharp objects.
- Always switch off at the mains before disconnecting any plug, cord or extension lead.
- Never carry the product by the cord.
- Never pull on the cord to disconnect any of the plugs.
- Use only AC mains supply voltage shown on the product rating label.
- It is recommended that the appliance should be supplied via a residual current device (RCD) with a tripping current of not more than 30 mA.
- Use at least a 10 Amp rated 1.0 mm² extension cord with a maximum of 25 meters and the cord shall be not lighter than:
 - If rubber insulated, ordinary tough rubber sheathed flexible cord (code designation 60245 IEC 53);
 - If polyvinyl chloride insulated, ordinary polyvinyl chloride sheathed flexible cord (code designation 60227 IEC 53).

- your finger on the switch or energising power tools that have the switch on invites accidents.
- Remove any adjusting key or wrench before turning the power tool on. A wrench or a key left attached to a rotating part of the power tool may result in personal injury.
- Do not overreach. Keep proper footing and balance at all times. This enables better control of the power tool in unexpected situations.
- Dress properly. Do not wear loose clothing or jewellery. Keep your hair, clothing and gloves away from moving parts. Loose clothes, jewellery or long hair can be caught in moving parts.
- If devices are provided for the connection of dust extraction and collection facilities, ensure these are connected and properly used. Use of dust collection can reduce dust-related hazards.
- Power tool use and care
 - Do not force the power tool. Use the correct power tool for your application. The correct power tool will do the job better and safer at the rate for which it was designed.
 - Do not use the power tool if the switch does not turn it on and off. Any power tool that cannot be controlled with the switch is dangerous and must be repaired.
 - Disconnect the plug from the power source and/or the battery pack from the power tool before making any adjustments, changing accessories, or storing power tools. Such preventive safety measures reduce the risk of starting the power tool accidentally.
 - Store idle power tools out of the reach of children and do not allow persons unfamiliar with the power tool or these instructions to operate the power tool. Power tools are dangerous in the hands of untrained users.
 - Maintain power tools. Check for misalignment or binding of moving parts, breakage of parts and any other condition that may affect the power tool's operation. If damaged, have the power tool repaired before use. Many accidents are caused by poorly maintained power tools.
 - Keep cutting tools sharp and clean. Properly maintained cutting tools with sharp cutting edges are less likely to bind and are easier to control.
 - Use the power tool, accessories and tool bits etc. in accordance with these instructions, taking into account the working conditions and the work to be performed. Use of the power tool for operations different from those intended could result in a hazardous situation.
- Service
 - Have your power tool serviced by a qualified repair person using only identical replacement parts. This will ensure that the safety of the power tool is maintained.
 - If the supply cord is damaged, it must be replaced by the manufacturer, its service agent or similarly qualified persons in order to avoid a hazard.

- Exercise extreme caution when changing direction on slopes.
- Do not mow excessively steep slopes.
- Use extreme caution when reversing or pulling the appliance towards you.
- Stop the blade(s) if the appliance has to be tilted for transportation when crossing surfaces other than grass, and when transporting the appliance to and from the area to be mowed.
- Never operate the appliance with defective guards or shields, or without safety devices, for example deflectors and/or grass catchers, in place.
- Switch on the motor according to instructions and with feet well away from the blade(s).
- Do not tilt the appliance when switching on the motor, except if the appliance has to be tilted for starting. In this case, do not tilt it more than absolutely necessary and lift only the part which is away from the operator. Always ensure that both hands are in the operating position before returning the appliance to the ground.
- Do not put hands or feet near or under rotating parts. For rotary mowers, keep clear of the discharge opening at all times.
- Never pick up or carry an appliance while the motor is running.
- Pull the plug from the socket:
 - whenever you leave the machine;
 - before clearing a blockage;
 - before checking, cleaning or working on the appliance;
 - after striking a foreign object. Inspect the appliance for damage and make repairs as necessary;
 - if the appliance starts to vibrate abnormally (check immediately).

4) Maintenance and storage

- Keep all nuts, bolts, and screws tight to be sure the appliance is in safe working condition.
- Check the grass catcher frequently for wear or deterioration.
- Replace worn or damaged parts for safety.
- For cylinder mowers, be careful during adjustment of the appliance to prevent entrapment of the fingers between moving blades and fixed parts of the appliance.

ozito

ECOMOW ELECTRIC MOWER

1000W 320mm

INSTRUCTION MANUAL

SPECIFICATIONS

Power:	1000W
No Load Speed:	3,200/min
Cutting Diameter:	320mm
Cutting Heights:	30mm, 50mm & 70mm
Catcher Capacity:	30 litre
Weight:	7.0kg

ozito.com.au

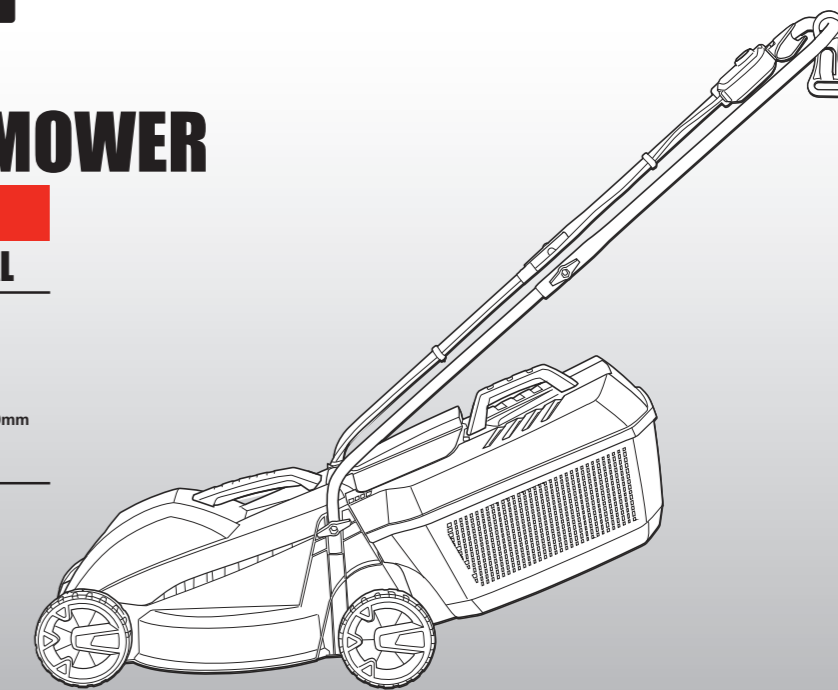

3 YEAR REPLACEMENT WARRANTY

WARRANTY

IN ORDER TO MAKE A CLAIM UNDER THIS WARRANTY YOU MUST RETURN THE PRODUCT TO YOUR NEAREST BUNNINGS WAREHOUSE WITH YOUR BUNNINGS REGISTER RECEIPT. PRIOR TO RETURNING YOUR PRODUCT FOR WARRANTY PLEASE TELEPHONE OUR CUSTOMER SERVICE HELPLINE:

Australia 1800 069 486
New Zealand 0508 069 486

TO ENSURE A SPEEDY RESPONSE PLEASE HAVE THE MODEL NUMBER AND DATE OF PURCHASE AVAILABLE. A CUSTOMER SERVICE REPRESENTATIVE WILL TAKE YOUR CALL AND ANSWER ANY QUESTIONS YOU MAY HAVE RELATING TO THE WARRANTY POLICY OR PROCEDURE.

The benefits provided under this warranty are in addition to other rights and remedies which are available to you at law.

Our goods come with guarantees that cannot be excluded at law. You are entitled to a replacement or refund for a major failure and for compensation for any other reasonably foreseeable loss or damage. You are also entitled to have the goods repaired or replaced if the goods fail to be of acceptable quality and the failure does not amount to a major failure.

Generally you will be responsible for all costs associated with a claim under this warranty, however, where you have suffered any additional direct loss as a result of a defective product you may be able to claim such expenses by contacting our customer service helpline above.

3 YEAR REPLACEMENT WARRANTY

Your product is guaranteed for a period of **36 months from the original date of purchase** and is intended for DIY (Do It Yourself) use only. If a product is defective it will be replaced in accordance with the terms of this warranty. Warranty excludes consumable parts, for example: grass catcher, wheels, blade, cord clips, bearings & carbon brushes

WARNING

The following actions will result in the warranty being void.

- If the tool has been operated on a supply voltage other than that specified on the tool.
- If the tool shows signs of damage or defects caused by or resulting from abuse, accidents or alterations.
- Failure to perform maintenance as set out within the instruction manual.
- If the tool is disassembled or tampered with in any way.
- Professional, industrial or high frequency use.

WHAT'S IN THE BOX

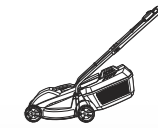

Electric Lawn Mower

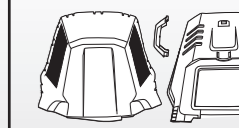

Grass Catcher

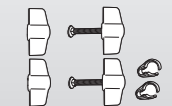

Handle Knobs, Handle Securing Set & Cable Clips

LMBLGTK-000

KNOW YOUR PRODUCT

ECOMOW ELECTRIC MOWER (ELM-1000)

- | | |
|--------------------|------------------------|
| 1 Motor cover | 8 Handle Knobs |
| 2 Lifting handle | 9 Rear wheel |
| 3 Lower handle | 10 Grass catcher flap |
| 4 Cord clips | 11 Handle securing set |
| 5 Lock-off button | 12 Grass catcher |
| 6 Start/stop lever | 13 Upper handle |
| 7 Front wheel | 14 Cord retainer |

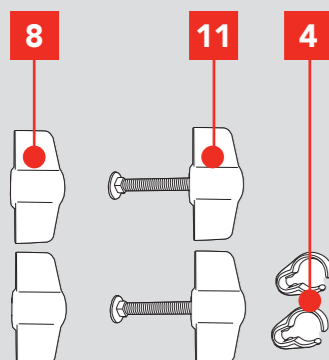
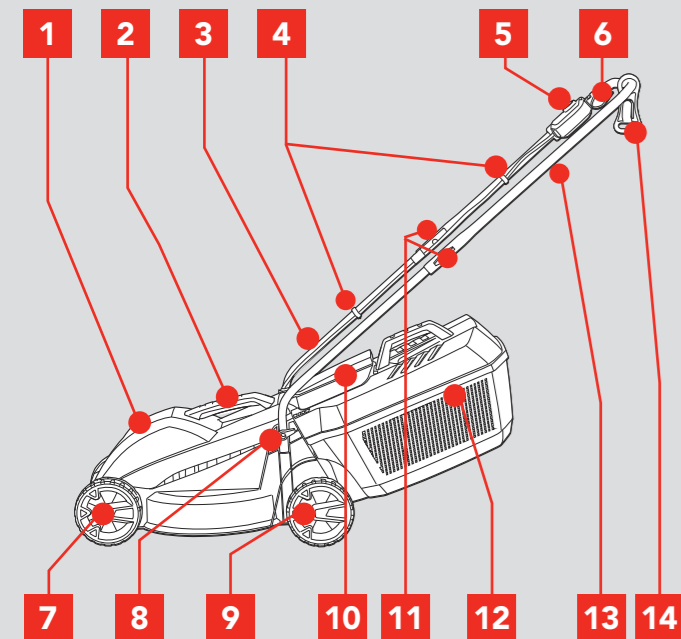

ONLINE MANUAL

Scan this QR Code with your mobile device to take you to the online manual.



SETUP & PREPARATION

1. ASSEMBLY

Fitting the Lower Handles to the Mower Body

WARNING! ENSURE THE TOOL IS DISCONNECTED FROM THE POWER SUPPLY BEFORE ASSEMBLY.

1. Fit the lower handle onto the threaded ends.

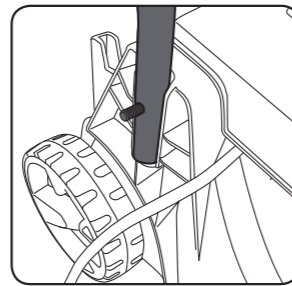

2. Fit and secure in place with the lower handle securing knobs.

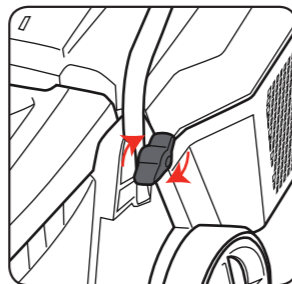

Fitting the Upper Handles to the Lower Handles

1. First fit the cord retainer, slide it over the upper handle end before fixing the upper handle to the lower handles.

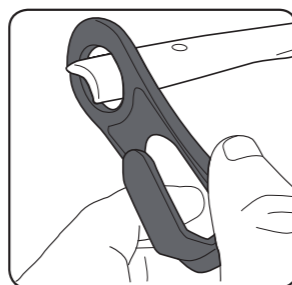

2. Place the upper handle over the upper ends of the lower handle. From the handle securing set, fit the bolts through the inner side of the lower handle and then through the holes in the upper handle. Secure in place by screwing the handle securing knobs over the protruding ends of the bolts.

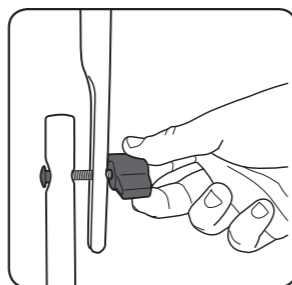

Securing the Power Cord to the Handles

1. Secure the power cord running from the switch housing to the body of the mower by using the two cord clips (supplied).

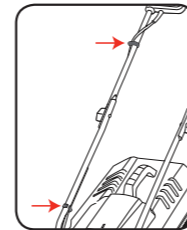

Assembling the Grass Catcher

1. Assemble the grass catcher handle onto the opening on the top of the grass catcher. The handle will click into position when aligned and fitted correctly.

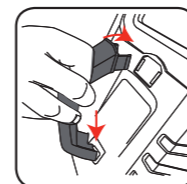

2. To assemble the grass catcher align the two halves and push them together, one side at a time. Ensure the two halves click together around the entire middle section.

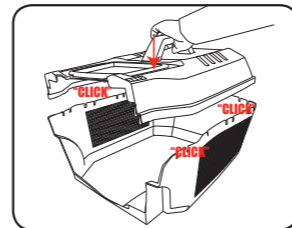

Fitting and Removing Grass Catcher

The catcher must be attached to the two hooks on the mower.

1. Lift up the catcher flap with one hand and guide the catcher with your other hand over the two hooks on the mower housing
2. Lower the grass catcher and allow it to sit in place. Lower the catcher flap.
3. To empty the grass catcher, lift the catcher flap with one hand then lift the grass catcher with the other hand up off the two raised housing clips.

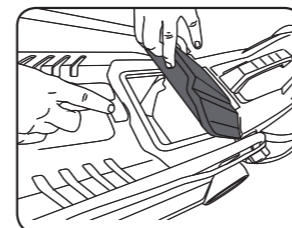
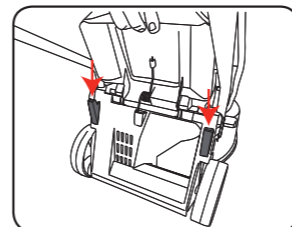

WARNING! WHEN ASSEMBLING THE GRASS CATCHER BACK TO THE MOWER AFTER EMPTYING, ALWAYS ENSURE THERE IS NO BUILD UP OF GRASS IN THE GRASS CHUTE. IF NEEDING TO CLEAR THE GRASS, ALWAYS ENSURE THE MOWER IS DISCONNECTED FROM THE POWER SUPPLY PRIOR TO CLEARING. A BUILD UP OF GRASS IN THE GRASS CHUTE MAY PREVENT GRASS FROM MOVING INTO THE GRASS CATCHER EFFECTIVELY.

OPERATION

2. PREPARATION

Using the Cord Retainer

The cord retainer prevents the extension cord from being disconnected during use.

1. Make a loop with the extension cord (socket end of cord) through the loop and secure over the hook.
2. Once fitted, connect the lawn mower power plug into the extension cord socket



Cutting Height Adjustment

To obtain the desired cutting height, the front and rear axles are repositioned on the underside of the mower housing.

WARNING! DISCONNECT THE MOWER FROM THE POWER SUPPLY AND ENSURE THE BLADE HAS STOPPED COASTING BEFORE ADJUSTING THE HEIGHT.

1. Turn the mower upside down.
2. Pull the wheel axle towards the front of the mower.
3. Locate the wheel axle into the desired cutting height adjustment position.

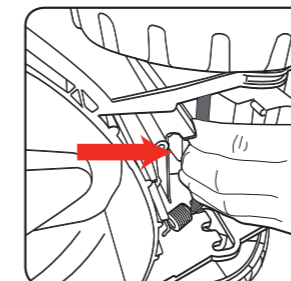

Note: Make sure that both front right and left wheel are located in the same cutting height adjustment position.

4. Pull the rear wheel axle towards the mower's catcher flap.
5. Locate the wheel axle into the desired cutting height adjustment position.

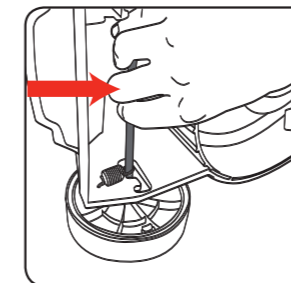

Note: Make sure that both rear right and left wheel are located in the same cutting height adjustment position.

Cutting Height Positions

1. 30 mm (lowest)
2. 50 mm
3. 70 mm (highest)

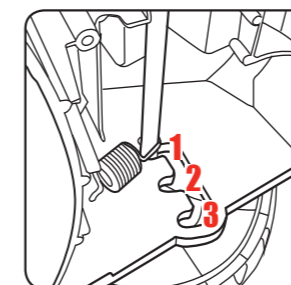

WARNING! TO REDUCE THE RISK OF ELECTRIC SHOCK, THE USE OF A RESIDUAL CURRENT DEVICE RATED AT 30mA OR LESS IS RECOMMENDED.

Switching On/Off

To prevent accidental start up of the motor the mower is fitted with a dual action switch

1. To start, press and hold the lock-off button.

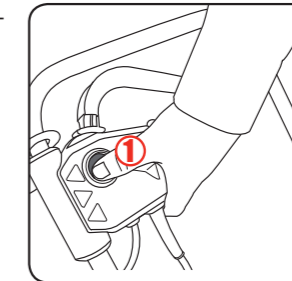

2. Pull the Start/stop lever towards the handle, the motor will start, then release the lock-off button
3. Release the Start/stop lever to stop the mower.

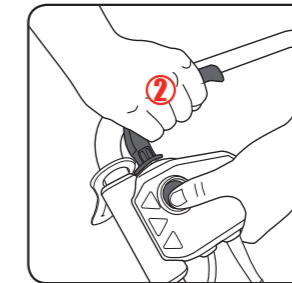

WARNING! THE BLADE WILL COAST AFTER THE SWITCH HAS BEEN RELEASED. BE AWARE OF THE NECESSARY TIME IT TAKES FOR THE BLADE TO STOP COASTING. DO NOT ATTEMPT TO STOP THE BLADE.

Overload Protection

The mower has an internal cut off switch which will stop the operation of the motor temporarily if overloaded. This cut off switch will suddenly stop the motor from operating should the motor become too hot during the operation of the mower.

First disconnect the mower from the power supply and inspect blade for any obstructions.

A wait of up to 2 minutes in cooling time, or longer depending on ambient temperature and the operation being performed, before switching On the mower and resuming normal operation.

3. HOW TO MOW

- Always use an approved extension lead suitable for power input of this tool.
- Heavy duty power leads recommended.
- While using your lawn mower always wear substantial footwear and long trousers.
- Make sure the lawn is clear of sticks, stones, wire and debris; they could be thrown by the blade.
- Before using the lawn mower and after any impact, check for signs of wear or damage and repair as necessary.
- Replace a worn or damaged blade together with the blade bolt to preserve balance.

WARNING! KEEP EXTENSION CORD AWAY FROM BLADES.



Start mowing the edge of the lawn nearest to the power point so the lead is laid out on the lawn you have already cut.

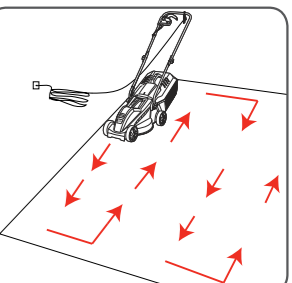

For best grass collection, always mow in a straight line; do not swing the lawn mower from side to side.

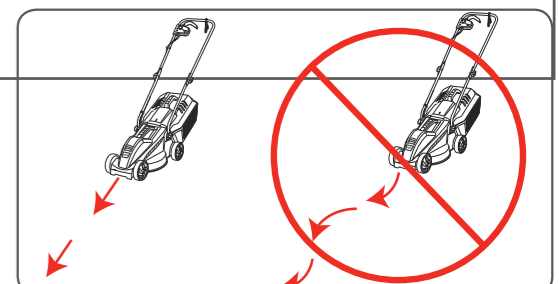

Do Not Overload the Mower

Mowing long thick grass may cause the motor speed to drop; you will hear a change in the motor sound. If the motor speed drops you may overload your lawn mower, which may cause damage. When mowing in long thick grass first cut with the cutting height set in the highest position, this will help reduce the load.

SPARE PARTS

Spare Part	Part Number
Carbon Brush (Pair)	SPBLW1800-13
Switch	SPBLW1800-02

Spare parts can be ordered from the Special Orders Desk at your local Bunnings Warehouse.
For further information, or any parts not listed here, visit www.ozito.com.au or contact Ozito Customer Service:
Australia 1800 069 486
New Zealand 0508 069 486
E-mail: enquires@ozito.com.au

DESCRIPTION OF SYMBOLS

V	Volts	Hz	Hertz
~	Alternating current	W	Watts
dB	Decibel (noise) rating	No	No load speed
/min	Revolutions or reciprocation per minute		Regulator compliance mark
	Read instructions		Warning
	Do not expose to rain		Double insulated
	Wear Eye, Ear & Breathing Safety Gear during use		Keep bystanders away
	Be aware of people around you and do not direct towards them		
	Disconnect and discontinue use should the power-cord be damaged		
	Disconnect from power supply when performing maintenance		
	Sound power level		Thrown objects can cause severe injury

CARING FOR THE ENVIRONMENT



Power tools that are no longer usable should not be disposed of with household waste but in an environmentally friendly way. Please recycle where facilities exist. Check with your local council authority for recycling advice.



Recycling packaging reduces the need for landfill and raw materials. Reuse of recycled material decreases pollution in the environment. Please recycle packaging where facilities exist. Check with your local council authority for recycling advice.

ELECTRICAL SAFETY

WARNING! When using mains-powered tools, basic safety precautions, including the following, should always be followed to reduce risk of fire, electric shock, personal injury and material damage.

Read the whole manual carefully and make sure you know how to switch the tool off in an emergency, before operating the tool.

Save these instructions and other documents supplied with this tool for future reference.

The electric motor has been designed for 230V and 240V only. Always check that the power supply corresponds to the voltage on the rating plate.
Note: The supply of 230V and 240V on Ozito tools are interchangeable for Australia and New Zealand.



This tool is double insulated therefore no earth wire is required.

To reduce the risk of electrical shock, a residual current device (rated 30mA or less) must be used.

GENERAL POWER TOOL SAFETY WARNINGS

WARNING! Read all safety warnings and all instructions. Failure to follow the warnings and instructions may result in electric shock, fire and/or serious injury. Save all warnings and instructions for future reference. The term "power tool" in the warnings refers to your mains-operated (corded) power tool or battery-operated (cordless) power tool.

- Work area safety**
 - Keep work area clean and well lit. Cluttered or dark areas invite accidents.
 - Do not operate power tools in explosive atmospheres, such as in the presence of flammable liquids, gases or dust. Power tools create sparks which may ignite the dust or fumes.
 - Keep children and bystanders away while operating a power tool. Distractions can cause you to lose control.
- Electrical safety**
 - Power tool plugs must match the outlet. Never modify the plug in any way. Do not use any adapter plugs with earthed (grounded) power tools. Unmodified plugs and matching outlets will reduce risk of electric shock.
 - Avoid body contact with earthed or grounded surfaces, such as pipes, radiators, ranges and refrigerators. There is an increased risk of electric shock if your body is earthed or grounded.
 - Do not expose power tools to rain or wet conditions. Water entering a power tool will increase the risk of electric shock.
 - Do not abuse the cord. Never use the cord for carrying, pulling or unplugging the power tool. Keep cord away from heat, oil, sharp edges or moving parts. Damaged or entangled cords increase the risk of electric shock.
 - When operating a power tool outdoors, use an extension cord suitable for outdoor use. Use of a cord suitable for outdoor use reduces the risk of electric shock.
 - If operating a power tool in a damp location is unavoidable, use a residual current device (RCD) protected supply. Use of an RCD reduces the risk of electric shock.
- Personal safety**
 - Stay alert, watch what you are doing and use common sense when operating a power tool. Do not use a power tool while you are tired or under the influence of drugs, alcohol or medication. A moment of inattention while operating power tools may result in serious personal injury.
 - Use personal protective equipment. Always wear eye protection. Protective equipment such as dust mask, non-skid safety shoes, hard hat, or hearing protection used for appropriate conditions will reduce personal injuries.
 - Prevent unintentional starting. Ensure the switch is in the off-position before connecting to power source and/or battery pack, picking up or carrying the tool. Carrying power tools with your finger on the switch or energising power tools that have the switch on invites accidents.
- Remove any adjusting key or wrench before turning the power tool on.** A wrench or a key left attached to a rotating part of the power tool may result in personal injury.
- Do not overreach. Keep proper footing and balance at all times.** This enables better control of the power tool in unexpected situations.
- Dress properly. Do not wear loose clothing or jewellery. Keep your hair, clothing and gloves away from moving parts.** Loose clothes, jewellery or long hair can be caught in moving parts.
- If devices are provided for the connection of dust extraction and collection facilities, ensure these are connected and properly used.** Use of dust collection can reduce dust-related hazards.
- Power tool use and care**
 - Do not force the power tool. Use the correct power tool for your application. The correct power tool will do the job better and safer at the rate for which it was designed.
 - Do not use the power tool if the switch does not turn it on and off. Any power tool that cannot be controlled with the switch is dangerous and must be repaired.
 - Disconnect the plug from the power source and/or the battery pack from the power tool before making any adjustments, changing accessories, or storing power tools. Such preventive safety measures reduce the risk of starting the power tool accidentally.
 - Store idle power tools out of the reach of children and do not allow persons unfamiliar with the power tool or these instructions to operate the power tool. Power tools are dangerous in the hands of untrained users.
 - Maintain power tools. Check for misalignment or binding of moving parts, breakage of parts and any other condition that may affect the power tool's operation. If damaged, have the power tool repaired before use. Many accidents are caused by poorly maintained power tools.
 - Keep cutting tools sharp and clean. Properly maintained cutting tools with sharp cutting edges are less likely to bind and are easier to control.
 - Use the power tool, accessories and tool bits etc. in accordance with these instructions, taking into account the working conditions and the work to be performed. Use of the power tool for operations different from those intended could result in a hazardous situation.
- Service**
 - Have your power tool serviced by a qualified repair person using only identical replacement parts. This will ensure that the safety of the power tool is maintained.

ADDITIONAL SAFETY INSTRUCTIONS FOR BLOWERS

Always wear adequate protective clothing when operating the tool to avoid injuries to face, eyes, hand, feet, head or hearing. Use safety glasses or a face shield, high boots or sturdy shoes, long trousers, work gloves, a hard hat and ear defenders.

Do not start the tool when it is upside down or when it is not in the operating position.

Switch the motor off and remove the plug when the tool is not being used, left unattended, being cleaned, being moved from one place to another or when the extension cord is entangled or damaged.

Do not operate the tool near people, especially children or pets. Turn it off if they get too close. Maintain a safe distance of at least 5m from other people when using the tool.

Never direct the blower direction nozzle towards bystanders or pets. Never blow debris in the direction of bystanders or pets. The operator is responsible for accidents or hazards occurring to other people or their property.

Do not handle the plug or the tool with wet hands and do not use the tool in the rain.

Use only outdoor rated extension leads that are so marked. Keep the extension cord away from heat, oil and sharp edges.

Ensure that the extension lead is secured in a manner that prevents it from disconnecting from the plug whilst in use.

Keep all the air intakes and the blower tube free of dust, lint, hair and other material that may cause a reduction in air flow.

Keep a balanced and stable stance while using the tool. Do not switch on the tool in enclosed or poorly ventilated spaces or in the presence of inflammable and/or explosive substances such as liquids, gasses and powders.

Do not get distracted and always concentrate on what you are doing. Use common sense. Never operate the tool when you are tired, sick or under the influence of alcohol or other drugs.

Do not operate this appliance with long loose hair or loose fitting jewellery. Tie long loose hair back and remove loose fitting jewellery.

Only operate the tool during broad daylight or with adequate artificial light.

This appliance is not intended for use by persons (including young children) with reduced physical, sensory or mental capabilities, or lack of experience and knowledge, unless they have been given supervision or instruction concerning use of the appliance by person responsible for their safety.

Children should be supervised to ensure that they do not play with the appliance.

Only use the tool according to the instructions given in this manual.

Check regularly that the screws are tight.

Do not use in the rain or leave outdoors while raining.

If the supply cord is damaged, it must be replaced by the manufacturer, its service agent or similarly qualified persons in order to avoid a hazard.

Note: Double insulation does not take the place of normal safety precautions when operating this tool. The insulation system is for added protection against injury resulting from a possible electrical insulation failure within the tool.

Using an Extension Lead

Always use an approved extension lead suitable for the power input of this tool. Before use, inspect the extension lead for signs of damage, wear and ageing. Replace the extension lead if damaged or defective. When using an extension lead on a reel, always unwind the lead completely. Use of an extension lead not suitable for the power input of the tool or which is damaged or defective may result in a risk of fire and electric shock.

Supply cords shall not be lighter than:

- if rubber insulated, ordinary tough rubber sheathed flexible cord (code designation 60245 IEC 53);
- if polyvinyl chloride insulated, ordinary polyvinyl chloride sheathed flexible cord (code designation 60227 IEC 53).

ozito

ELECTRIC BLOWER

1800W

INSTRUCTION MANUAL

SPECIFICATIONS

Motor:	1800 Watt
Input:	230 – 240V – 50Hz
No Load Speed:	15,000/min
Max. Air Volume:	350m ³ /hour
Max. Air Speed:	320km/hour
Noise Level:	100dB
Weight:	2.8kg

ozito.com.au

3 YEAR REPLACEMENT WARRANTY

WARRANTY

IN ORDER TO MAKE A CLAIM UNDER THIS WARRANTY YOU MUST RETURN THE PRODUCT TO YOUR NEAREST BUNNINGS WAREHOUSE WITH YOUR BUNNINGS REGISTER RECEIPT. PRIOR TO RETURNING YOUR PRODUCT FOR WARRANTY PLEASE TELEPHONE OUR CUSTOMER SERVICE HELPLINE:

Australia 1800 069 486
New Zealand 0508 069 486

TO ENSURE A SPEEDY RESPONSE PLEASE HAVE THE MODEL NUMBER AND DATE OF PURCHASE AVAILABLE. A CUSTOMER SERVICE REPRESENTATIVE WILL TAKE YOUR CALL AND ANSWER ANY QUESTIONS YOU MAY HAVE RELATING TO THE WARRANTY POLICY OR PROCEDURE.

The benefits provided under this warranty are in addition to other rights and remedies which are available to you at law.

Our goods come with guarantees that cannot be excluded at law. You are entitled to a replacement or refund for a major failure and for compensation for any other reasonably foreseeable loss or damage. You are also entitled to have the goods repaired or replaced if the goods fail to be of acceptable quality and the failure does not amount to a major failure.

Generally you will be responsible for all costs associated with a claim under this warranty, however, where you have suffered any additional direct loss as a result of a defective product you may be able to claim such expenses by contacting our customer service helpline above.

3 YEAR REPLACEMENT WARRANTY

Your product is guaranteed for a period of **36 months from the original date of purchase**. If a product is defective it will be replaced in accordance with the terms of this warranty. Warranty excludes consumable parts, for example: blower tube, carbon brushes.

WARNING

The following actions will result in the warranty being void.

- If the tool has been operated on a supply voltage other than that specified on the tool.
- If the tool shows signs of damage or defects caused by or resulting from abuse, accidents or alterations.
- Failure to perform maintenance as set out within the instruction manual.
- If the tool is disassembled or tampered with in any way.
- Professional, industrial or high frequency use.

WHAT'S IN THE BOX



Blower



Blow Tube



Direction Nozzle



Assembly Screws

LMBLGTK-000

KNOW YOUR PRODUCT

ELECTRIC BLOWER (BLW-1800)

- 1. Direction nozzle
- 2. Blow tube
- 3. Handle
- 4. On/Off trigger
- 5. Cord retaining hook
- 6. Air intake vent
- 7. Assembly screws 2 x 12mm

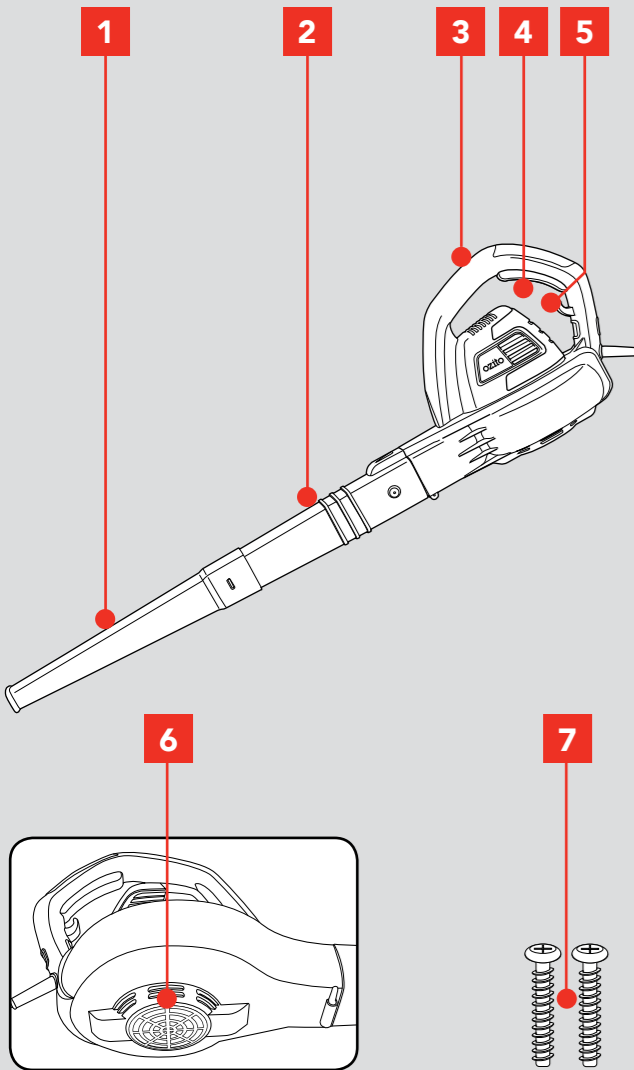

ONLINE MANUAL

Scan this QR Code with your mobile device to take you to the online manual.



SETUP & PREPARATION

1. ASSEMBLY

Connecting the blow tube and direction nozzle

WARNING! ALWAYS ENSURE THE BLOWER IS DISCONNECTED FROM THE POWER SUPPLY DURING ASSEMBLY AND/OR MAINTENANCE.

1. Unpack the blow tube and direction nozzle.

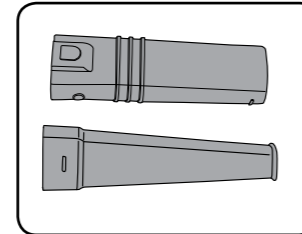

2. Connect larger end of the direction nozzle to the smaller end of the blow tube.

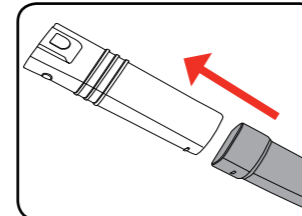

3. Ensure that all 3 buttons on the blow tube sit within the holes in the direction nozzle.

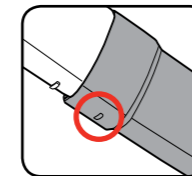

4. Connect the blow tube to the blower housing, ensuring that the blower housing tabs click into the holes in the blow tube.

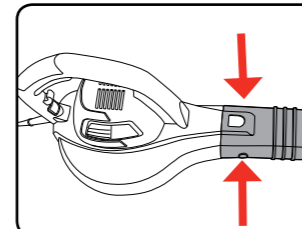

5. Secure the blower tube to the blower housing with the two 12mm screws.

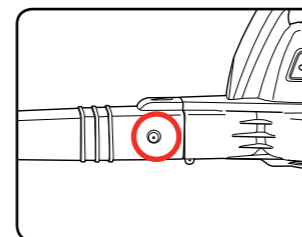

Using the extension cord retaining hook

The cord retaining hook is used to "anchor" an extension cord when it is connected to the power lead of the tool. It prevents the extension cord from being accidentally disconnected from the blower's power cable or shaken loose during use. It should be used at all times.

1. Make a loop in the end of the extension lead and pass the loop through the hole in the rear of the handle.

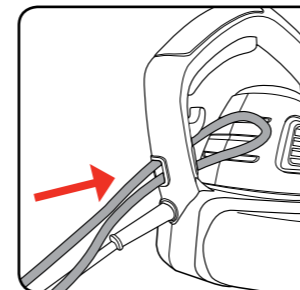

2. Hook the loop over the cord retaining hook. Pull the extension cord to secure it in position over the cord retaining hook.

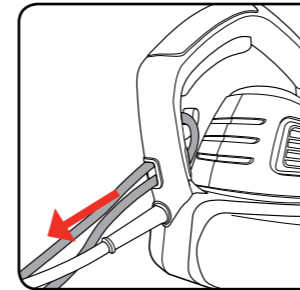

3. Connect the extension lead to the power cord.

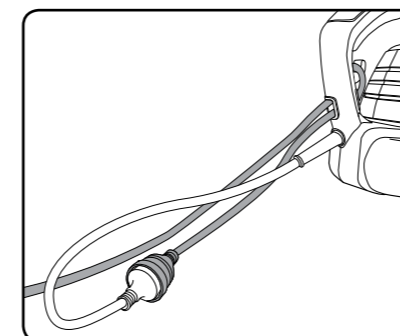

Route the power and extension cord away from the work area to prevent contact with the blower.

Note: Always use an approved extension lead suitable for the power input of this tool.

OPERATION

2. TRIGGER SWITCH

WARNING! TO REDUCE THE RISK OF ELECTRIC SHOCK, THE USE OF A RESIDUAL CURRENT DEVICE RATED AT 30mA OR LESS IS RECOMMENDED.

Turning ON

To turn the blower on, depress the trigger switch.

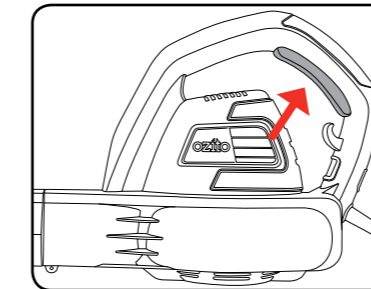

Turning OFF

To turn the blower off, release the trigger switch.

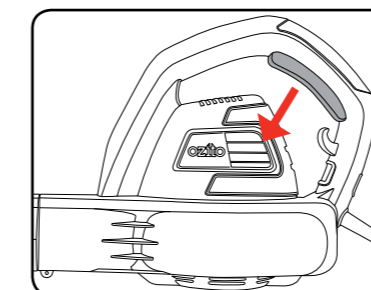

3. USING THE BLOWER

WARNING! DO NOT USE THE BLOWER WITH ANY TYPE OF ACCESSORY OR ATTACHMENT. SUCH USAGE MIGHT BE HAZARDOUS.

Blowing

The blower can be used to clean corners, fences, walls or beneath cars.

Hold the blower firmly, turn the trigger switch on, point the jet of air in front of you and move forward slowly. Move the blower from side to side, with the tube several inches above the ground.

Be careful where you point the jet of air as it can move heavy material and cause injury or damage to bystanders.

Note. Be aware of other people and animals in the area where you are to be operating the blower.

Note. Avoid collisions with hard objects which could damage your machine.

WARNING! DO NOT SWITCH THE MACHINE ON IN ENCLOSED OR POORLY VENTILATED SPACES OR IN THE PRESENCE OF FLAMMABLE AND/OR EXPLOSIVE LIQUIDS, GASES AND POWDERS.

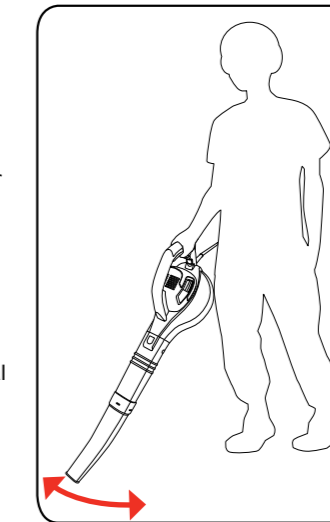

MAINTENANCE

4. GENERAL MAINTENANCE

WARNING! BEFORE CLEANING YOUR BLOWER OR CARRYING OUT ANY MAINTENANCE PROCEDURE, MAKE SURE THAT THE MOTOR IS OFF AND THE BLOWER IS DISCONNECTED FROM THE POWER SUPPLY TO PREVENT ACCIDENTAL STARTING.

- Keep air intake clean and air vents free of debris to avoid overheating the motor.
- Do not use cleaning agents to clean the plastic parts of the tool. A mild detergent on a damp cloth is recommended. Water must never come into contact with the tool.
- If the blower vibrates abnormally, stop motor immediately. Abnormal vibration usually indicates a mechanical problem continued operation could lead to injury or damage.
- No lubrication is necessary as the motor is equipped with lifetime-lubricated bearings.

Note: Ozito Industries will not be responsible for any damage or injuries caused by the repair of the tool by an unauthorised person or by mishandling of the tool.