

# ASSEMBLY INSTRUCTION FOR MAXI ULTRA H2

**WARNING:** Serious injury or death can be caused by toppling furniture

**Help prevent tip-over:**

- Anchor this product to a wall or other suitable surface
- Check anchors regularly
- Avoid placing TVs on top unless the TV is also anchored
- Use drawer locks to prevent children climbing

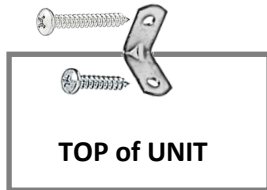

When attaching unit to wall put safety bracket in middle of unit with 16mm pan head screw then 25mm pan head screw into wall. For plasterboard without a stud it is recommended to use a plug with screw (not provided).



## PARTS IDENTIFICATION LIST

1 x L & R GABLE

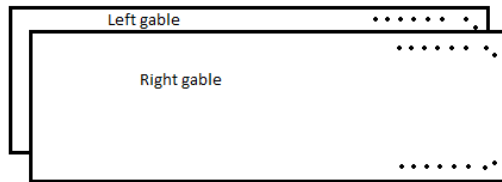

1 BOTTOM KICK



1x CAM SHELF

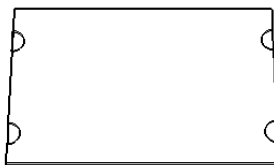



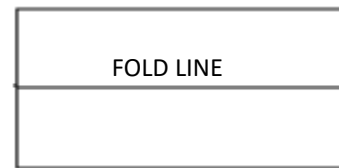







1 x BACKING BOARD FOLDED IN THE MIDDLE



2 x FIXED SHELF

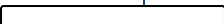

NO	MODEL	DESCRIPTION	QTY	NO	MODEL	DESCRIPTION	QTY
1		CONFIRMAT SCREWS 50mm x 5mm	14	8		WHITE CAMS	4
2		CAPS	14	9		CAM PINS	4
4		BACKING NAILS	54	10		16mm PAN HEAD SCREWS	1
5		16mm WOOD SCREW	12	11		25mm PAN HEAD SCREWS	1
6		30mm HANGING RAIL	1	12		"L" SAFETY BRACKET	1
7		30mm FLANGES—PER SET OF 2	1				



# MULTISTORE

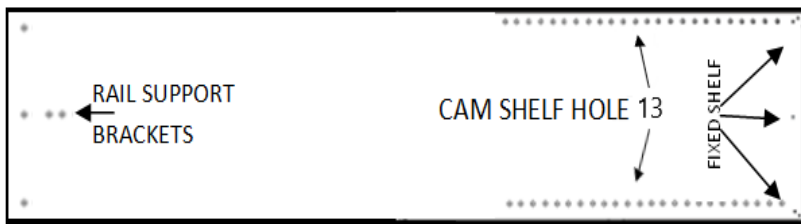

TAKE YOUR GABLES AND LAY THEM OUT FLAT, YOU SHOULD HAVE QTY 2 GABLES L&R NEXT STEP REQUIRES YOU TO OPEN PART 2 AND RETREIVE THE INFILL & SCREWS



INSERT YOUR 4 PINS (9) INTO THE HOLE NO: (13) PROVIDED. INSERT THE CAMS INTO THE HOLES PROVIDED ON THE BOTTOM OF THE SHELF. USING SCREW DRIVER TWIST CAM INTO LOCK POSITION.

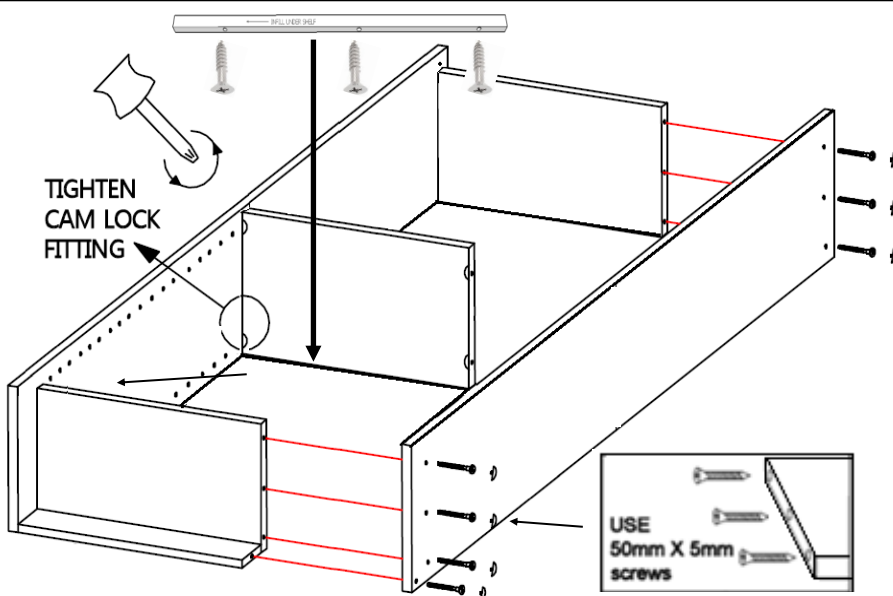

ALIGN FIXED SHELVES + KICK BOARD TO SIDE GABLES TIGHTEN ALL SCREWS AND CAP.

FOLD OUT BACK, PROCEED TO NAIL THEM INTO POSITION MAKING SURE YOU ARE SQUARE.

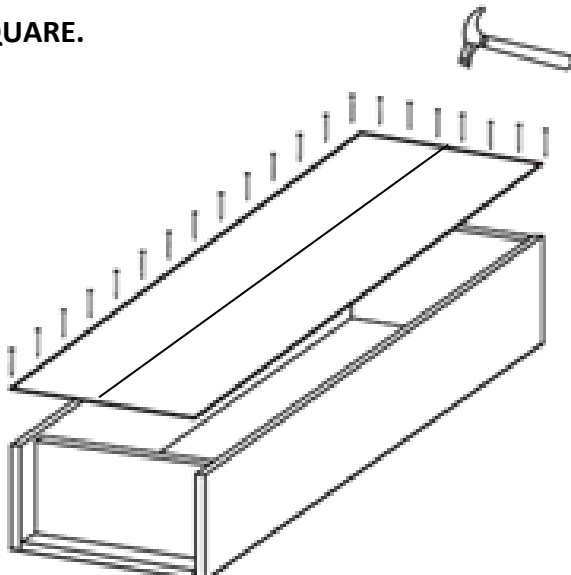

## NEXT STEP.

TAP INTO POSITION YOUR FLANGES INTO THE HOLES PROVIDED IF WISH YOU CAN PUT 1 SCREW IN THE FLANGE IN THE WHOLE PROVIDED NOW INSERT YOUR HANGING RAIL.

YOUR UNIT IS NOW READY TO BE PUT INTO PLACE.

NEXT. GO TO YOUR DRAWER ASSEMBLY SHEET ON HOW TO CREATE YOUR DRAWER.